

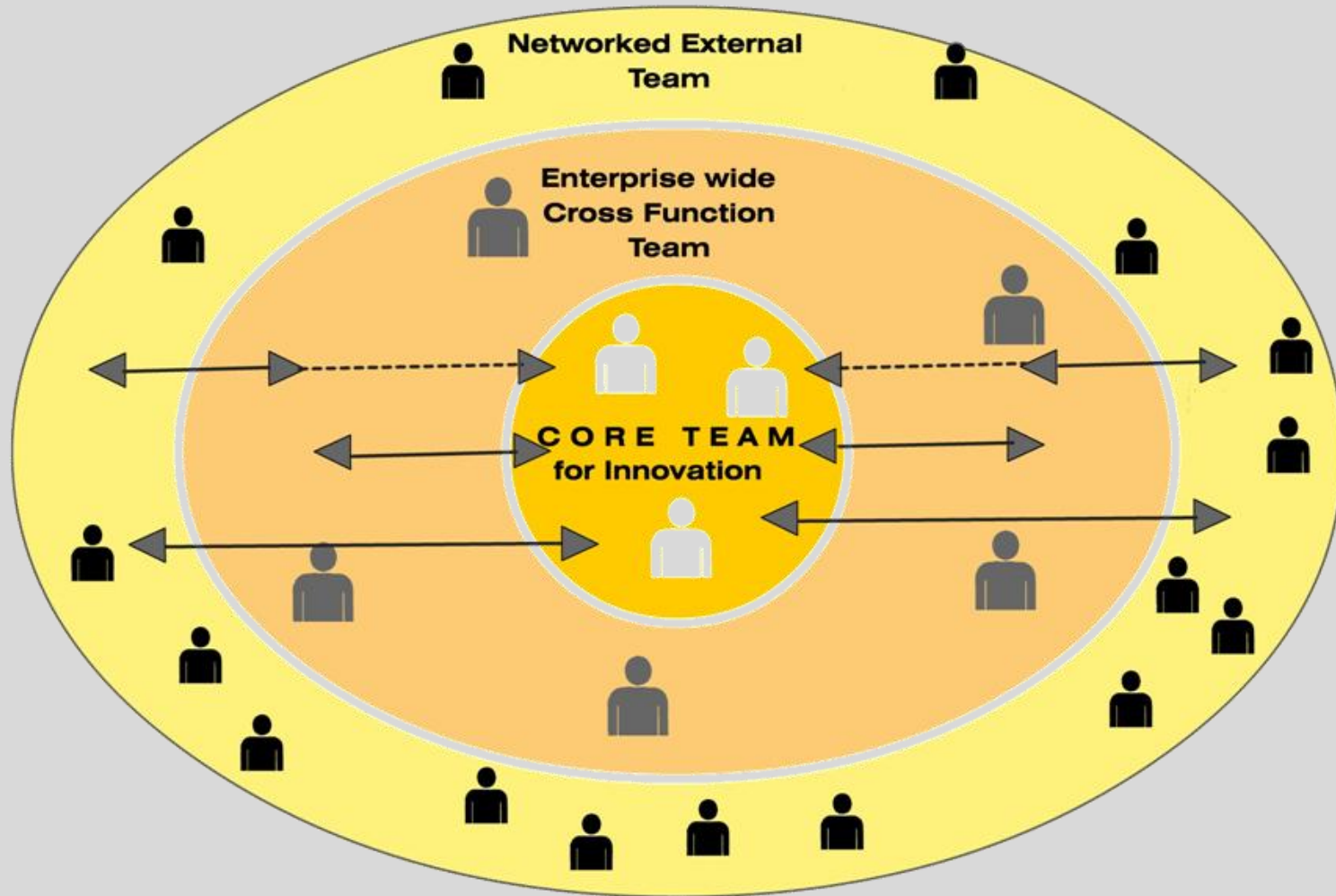

Serial Innovation in Fuel Dispensers

1. Z-Line (1989)
2. Bullet (1998)
3. MPD (2002)
4. **Oval (2005)**
5. SureFill (2008)

Collaborative Innovation Model



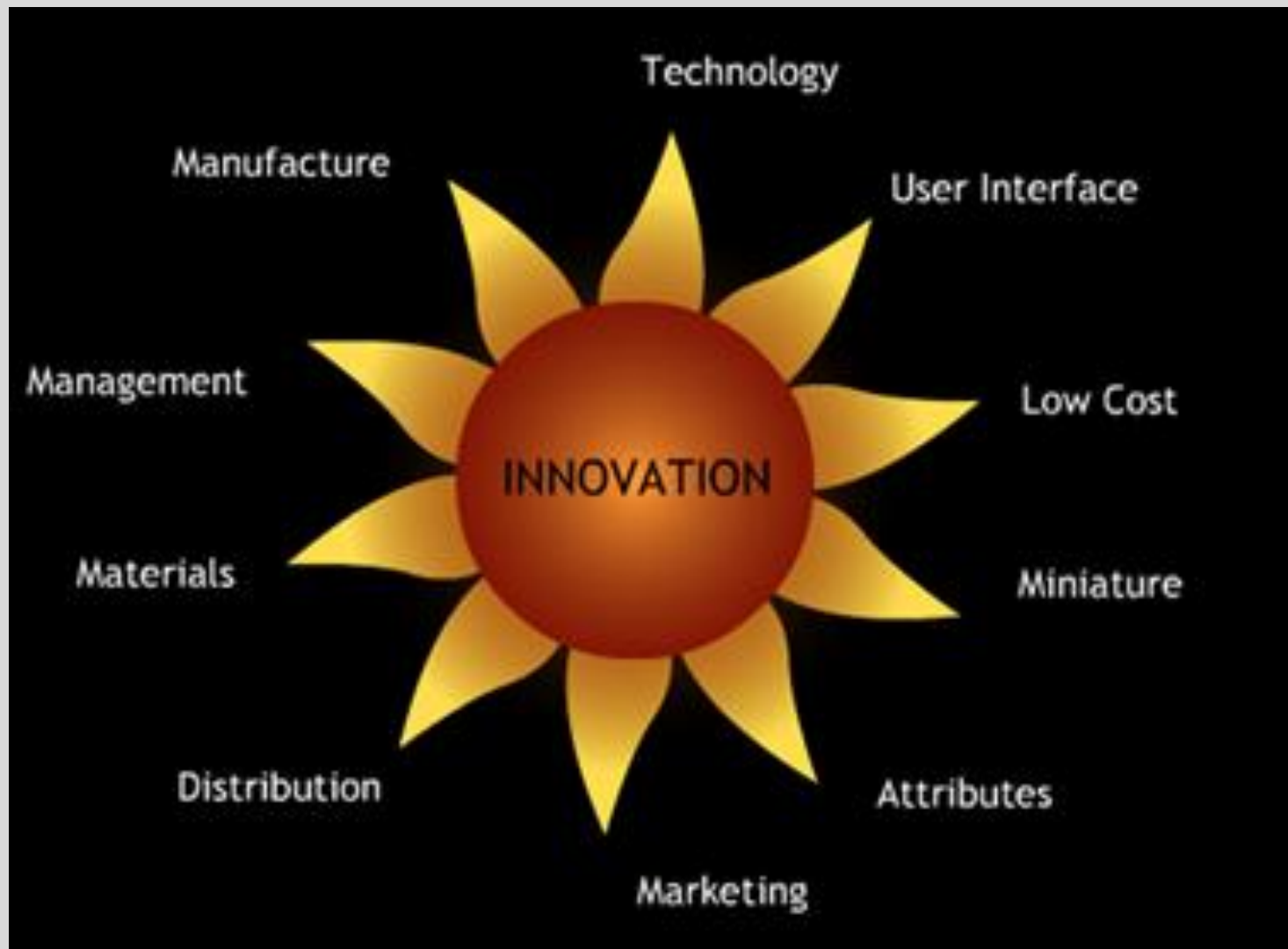



Design of OVAL DISPENSER for ONGC (2006)

ONGC - NID - MIDCO - IIT Bombay

Oval Branding

- User Convenience
- Watch the fuel
- Display comes to user
- Unique form and identity
- Best quality at low price

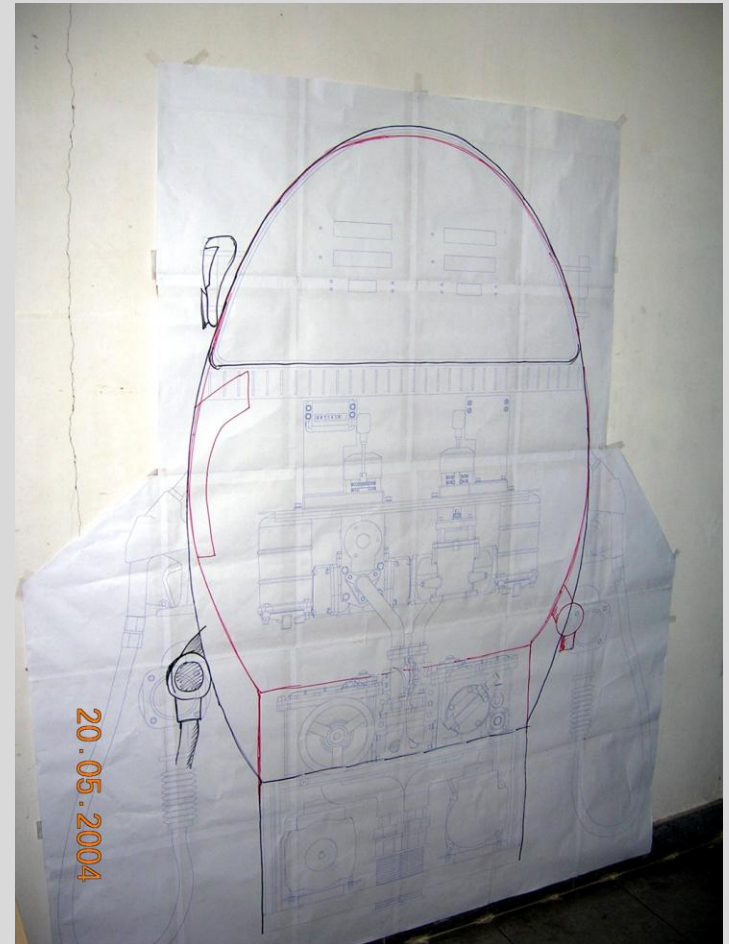



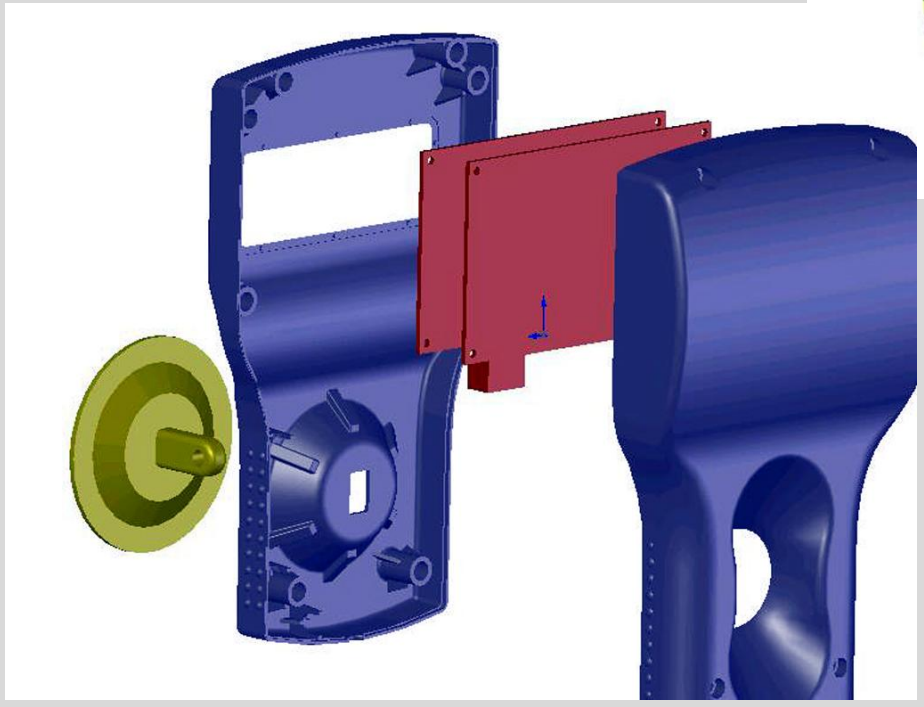
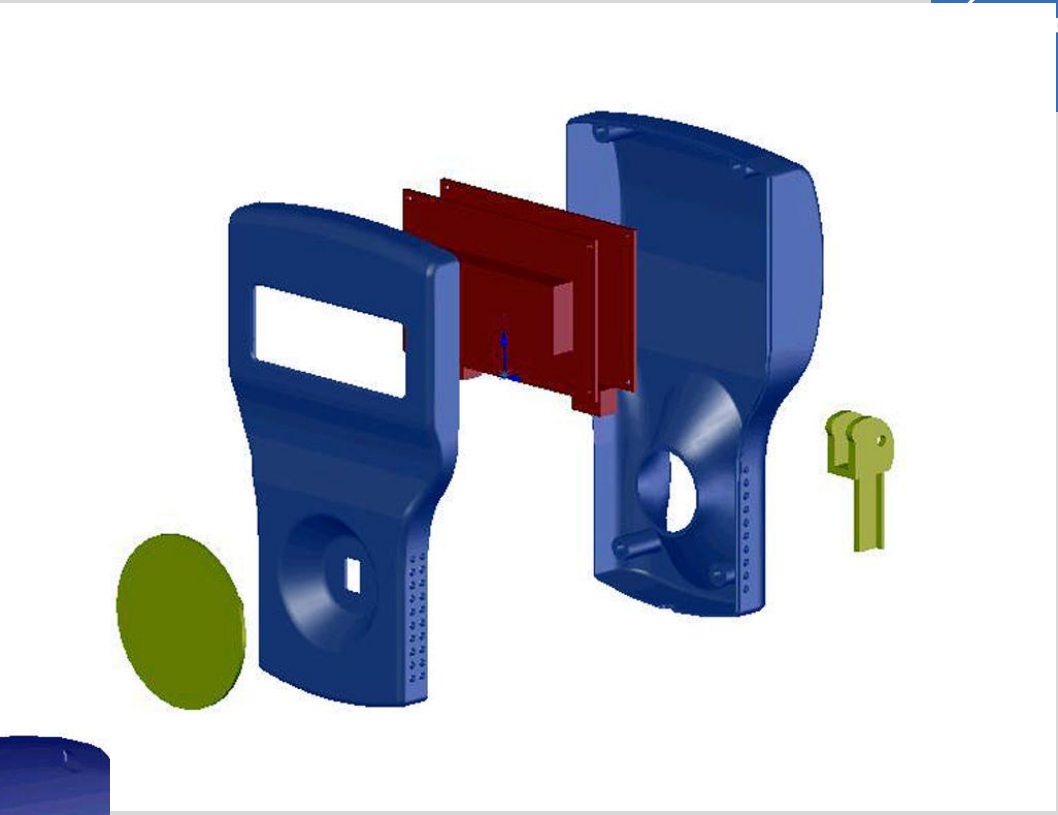















05.02.2005



09.12.2004



09.12.2004







Assembly Design

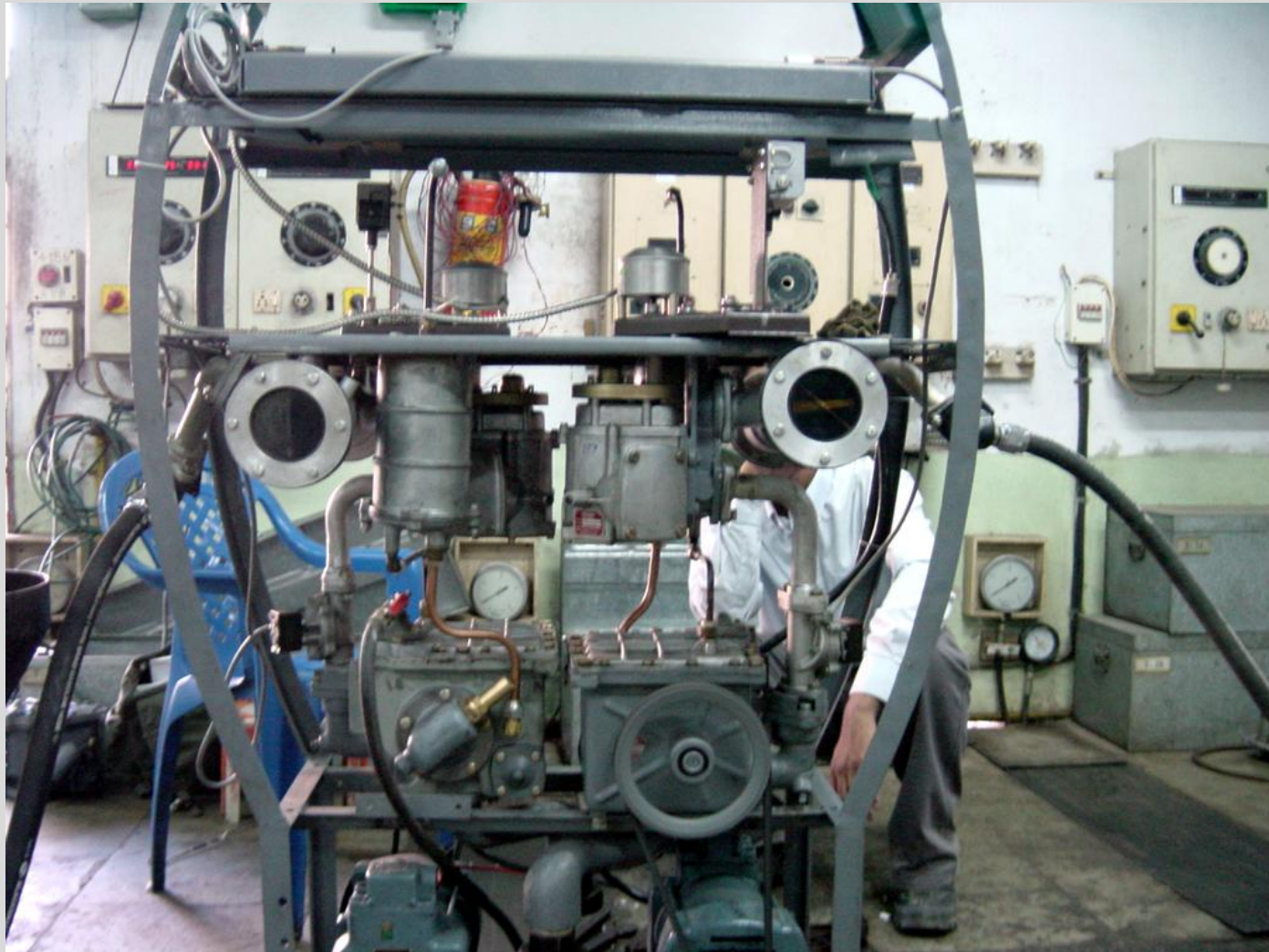



09.12.2004

Logo Manufacturing



Chassis Design



Chassis Design

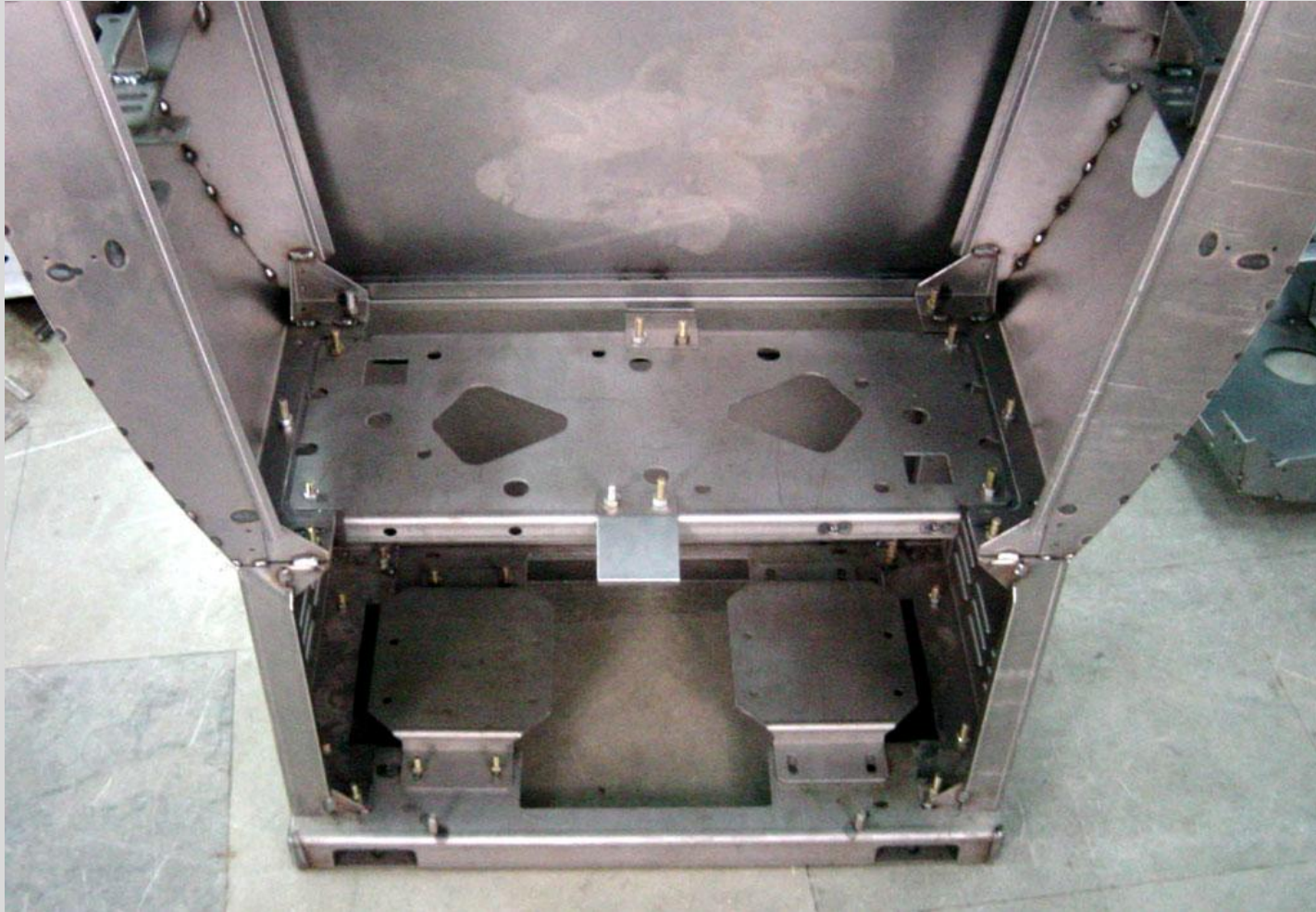

Chassis Design



Product Assembly with Logo



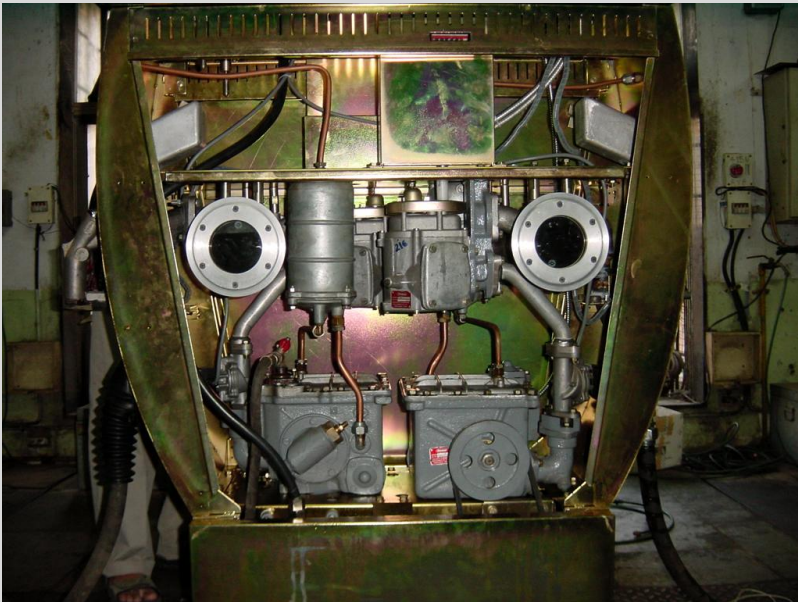

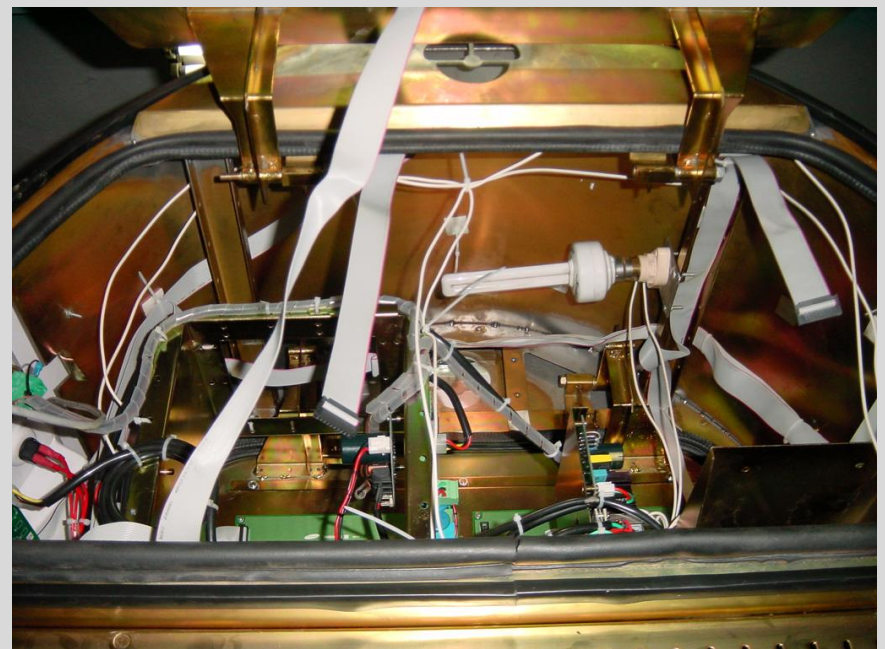
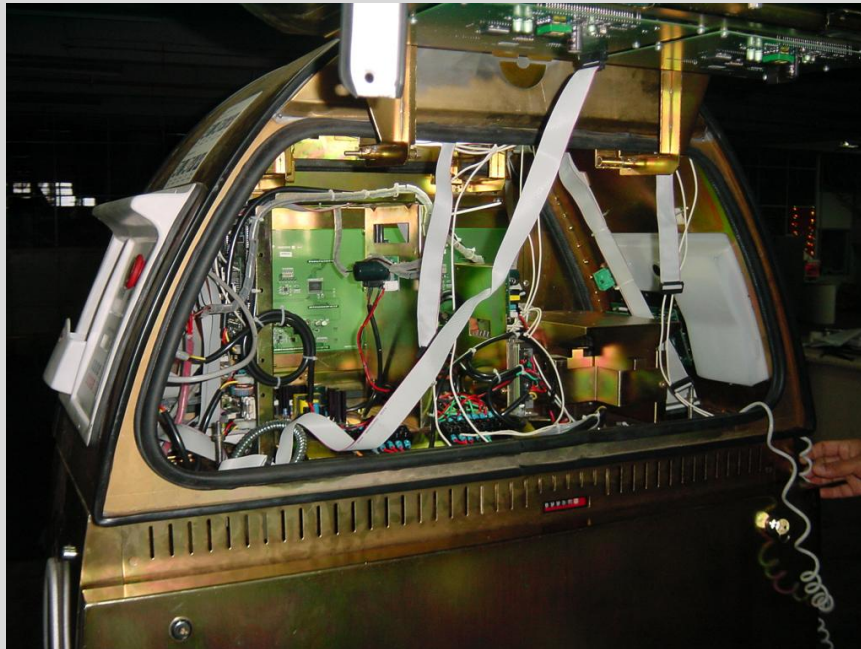
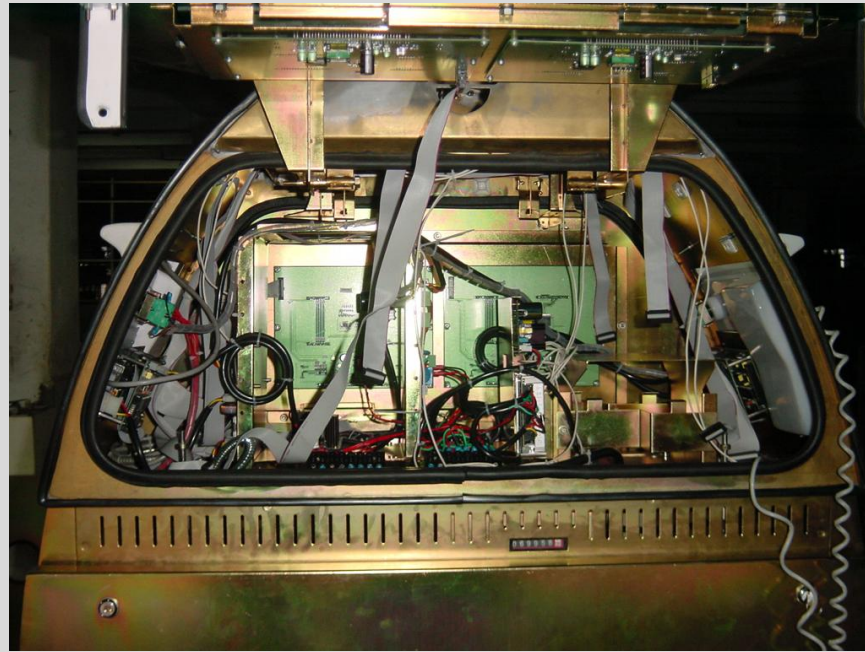







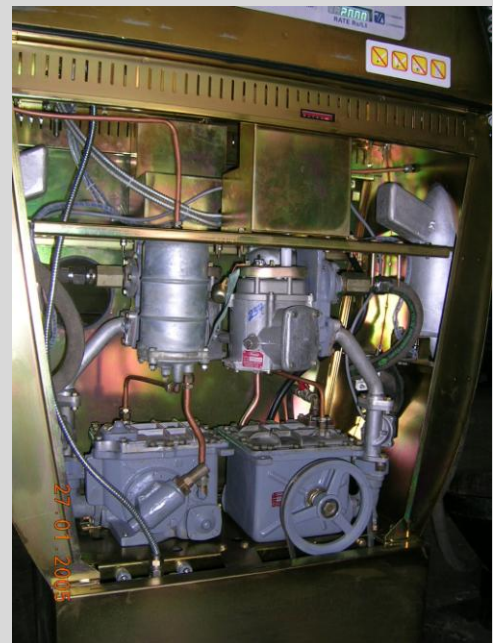

Salient Features

- Design for user convenience
- Use of high technology
- Modular construction
- Unique shape



Nozzle Boot Holder



Control Panel



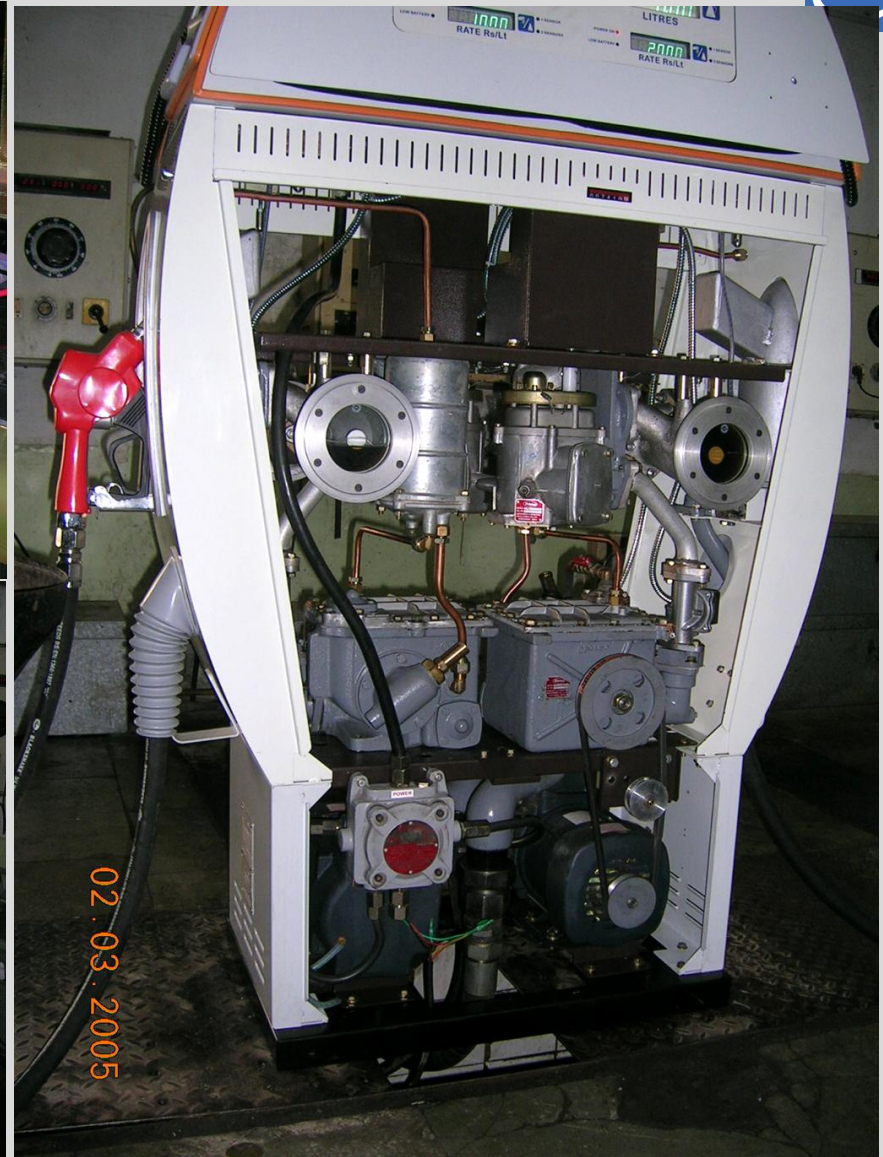

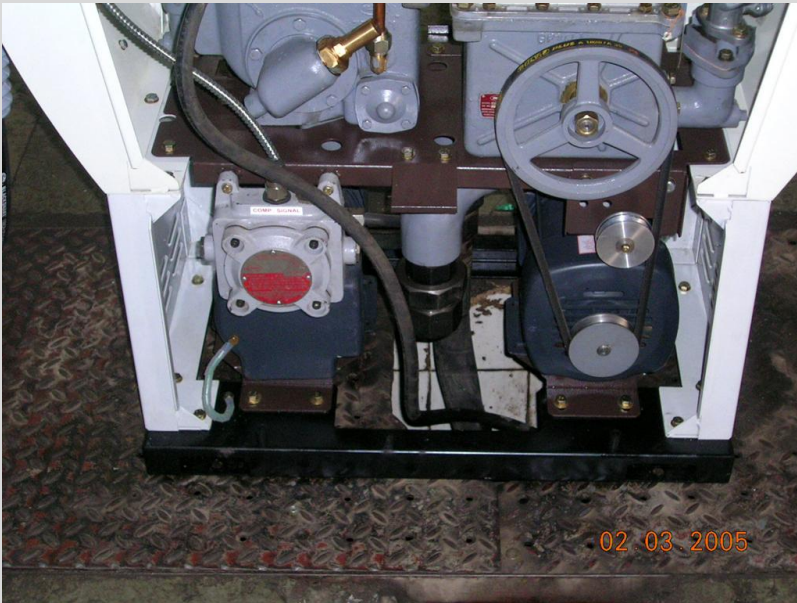

Display Doors



Connectors and Routing of Wires

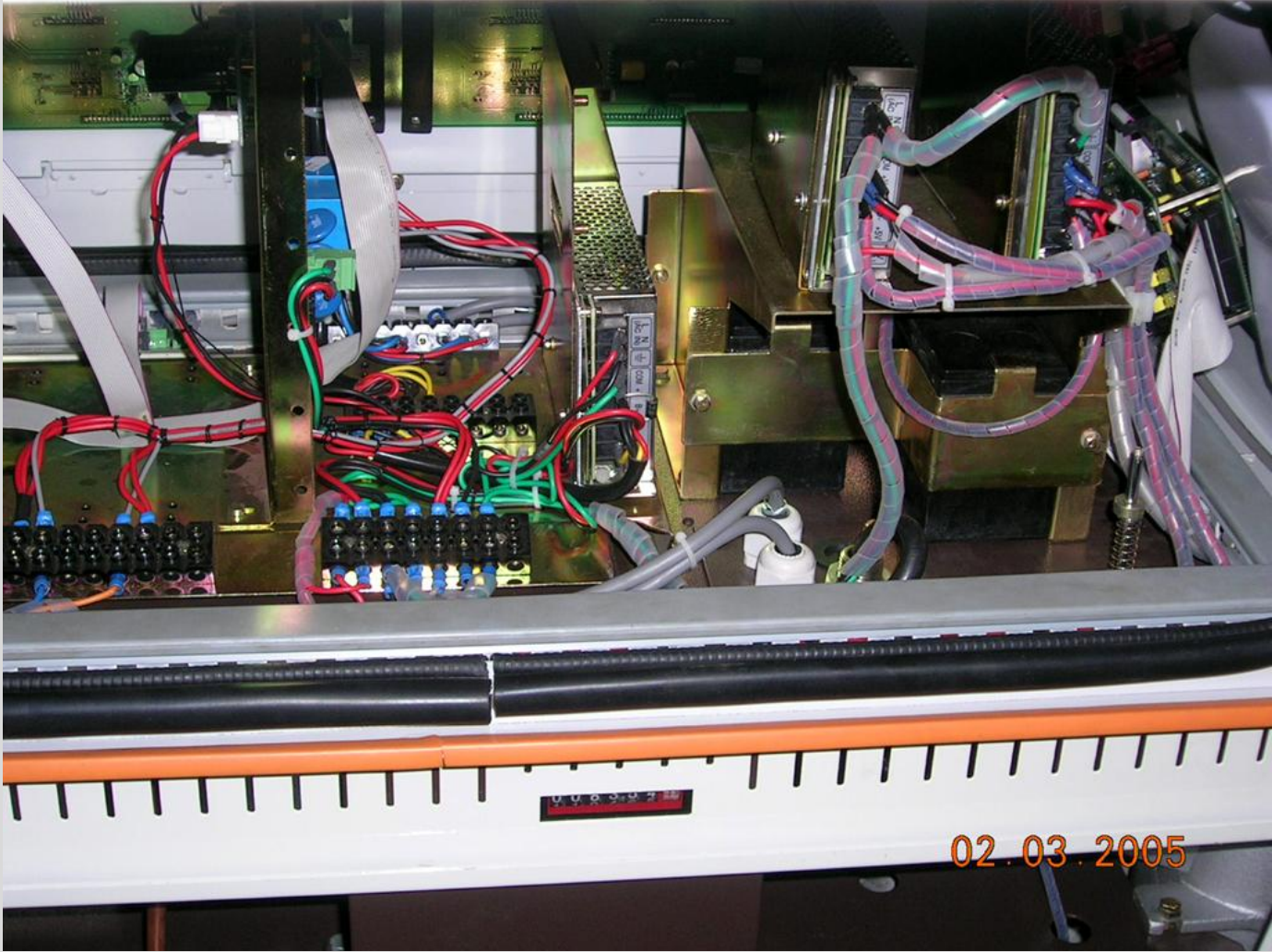



Innovation by Design



Read Further



Z-line (1989)



Bullet (1998)



MPD (2002)



SureFill (2008)