

Redesign of car interior for elderly people

Industrial Design project II

Utkarsh Gautam

05613806

Guided by-

Prof. G.G. Ray

Industrial Design Centre

IIT Bombay



The project deals with the making / adapting the personnel car interior more suitable/ acceptable by senior citizens. The objective is to make the travel experience a bit comfortable and less offending.





Introduction

One of the hazards of the aging is the increasingly failing health. On whole the health and stamina of an individual declines with age. This sometimes requires need of encouraging which could be either in form of design suitability.

Body degeneration is one of the most troubling parts which affect their dealing with every activity.

The modern society is organized in a way as suited to the majority population distribution. But reality is going to be different as elderly would comprise a greater degree of population some time from now. A fact is that, in many situations, car is the easiest 2 travel mode for older people facing declining physical skills.





Defining the Problem

The area of concern is to be addressed by the effective solution, by making the commuting experience of elderly people to be more comfortable; there by decreasing the stress physically and psychologically.

“Daily interaction with the mode of transport (car in this case) having a crunch of space, along their physical limitations like joint movement restriction makes a combination, which is difficult to deal by them.”



Present condition

The population of India stands at more than 1 billion owing 7% of its composition of elderly people and which is project to grow to 10% till 2020.

And, this segment is still under-served. With the consideration given to this, same model could be well applicable to younger group. As of now the extra effort to address those concerns is lacking.

| Age distribution of population (%) | | | |
|------------------------------------|------|------|------|
| | 1992 | 1997 | 2007 |
| 0–4 | 12.8 | 11.7 | 10.0 |
| 5–14 | 22.9 | 22.1 | 19.5 |
| 15–59 | 57.7 | 59.1 | 62.3 |
| 60 & above | 6.6 | 7.1 | 8.3 |

Source - Population is as per 1991 Census, IRS
Senior citizens Projection : 78million by 2020





Aim of study:

Study was done to get a hold of the present usage scenario and user aspirations based on the users lifestyle and daily routine.

In this project the upper stratum of society is taken as the target group because of the fact, that they are the people who actually have more freedom to indulge in their own idea of life.

Study is concerned with the people from age group 60-90 yrs of the age group who are still active in their daily routine. They engage themselves in some form of activity for maintaining social obligations. It is also to find out the characteristics and behavior as related to their vehicle use while using the rear seat.



Approach

Beneficiary -

- People Alone living 60+
- Status Upper middleclass
- Usage Daily (short duration)

Age related problems affect these people and as daily encounter with the vehicles is imminent.

These people were quiet active of their age and generally travel alone either for socializing or other commitments in their own car.





Problem area -

- Ingress
- Sitting
- Egress
- Miscellaneous

 were selected as core areas to work upon. These are not to be dealt as separate issues but interrelated with one another.

This time spent in the rear seat of the car may vary from 2 hrs to 4 hrs, not necessarily at a stretch.





Design way

The flow of events in progressing through the project as

- Situation analysis- understanding and evaluating need for a new product concept
- Product proposal- lacunae area
- Data collection and analysis
- Idea generation
- Concept development and exploratory modeling
- Product detailing
- Evaluation and improvement
- Final Prototype development



Market Survey:

The market survey included studying the different vehicle's interiors to understand the basic setting and correlation of different units which constitute together for interiors and to identify the problem area some clues also.

An effort was also made to understand the interiors along with the positioning of components and different mechanisms employed to operate the various units e.g. door opening, seat backrest controls.

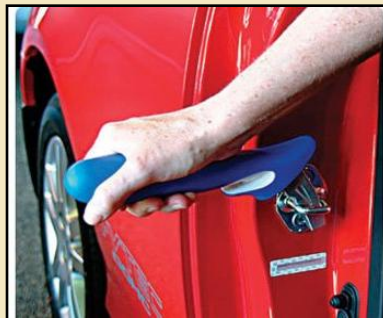

Grab bar

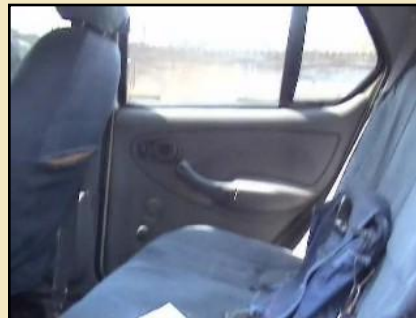

Elbow support



Storage space



Lumbar support



User Study:

This includes the user profile, habits, lifestyle, preferences, current usage and aspirations. Here the classification of issues faced was made into activity based 4 broad categories viz.

- Ingress
- Stay
- Egress
- Miscellaneous

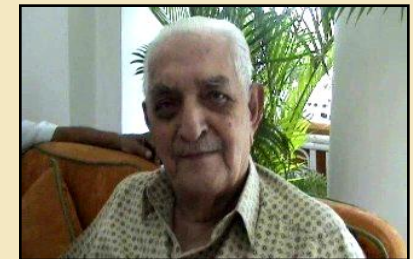

A total of 9 people were observed varying from 76- 86 yrs of age.



Ingress:

1. A degree of freedom in door openings
2. Type of mechanism in door handles like rotate or press
3. Support during moving in the vehicle, near door and also at seat
4. Locking of door
5. Personal needs vary

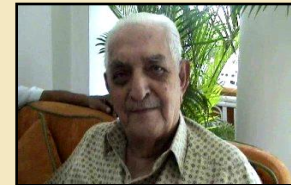

Stay:

1. Min. 1 hr is the time spent in car rear seat
2. A/C preferred
3. Music/No music
4. More leg space required
5. Foot rest is must
6. Extra customizable cushioning is requisite
7. Accessories - Water bottle, Suitcase, Bag
8. Safety issues like door handles , arm rest's cushioning
9. Personal needs vary

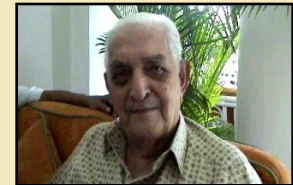

Egress:

- A degree of freedom in door openings
- Type of mechanism in door handles like rotate or press
- Support during moving out of the vehicle, near door, at back of front seat or at seat
- Opening of door
- Personal needs vary

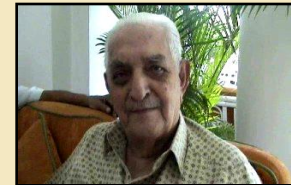



Miscellaneous:

Psychological -

- Sense of well being i.e. in spite of problems they demand acceptance as perfectly healthy .
- Having certain notions, like sitting on the diagonal opposite to the driver
- Adamant about hygiene

Security -

- Less trust on the person driving the vehicle
- Fear from being hurt

Thus, normally all the problems and requirements were distributed well accordingly and pattern noted. The scope of redesign was not thought to be constricted by any of the limits as some of the subjects were sharing a bond with their cars.



Analysis

Method: The analysis method used were

- **Biomechanics -**

Joint motion study during ingress, stay and egress. In this method the movement of different parts of the body was studied in relation with car in real time.

- **Video analysis -**

Movement analysis using video documentation. As it is possible that some of the important points may be missed in real time study, so the method of video analysis was then adopted to carry out the posture observation.

- **Questionnaire -**

Questionnaire was prepared to find out the realization among the elderly people of their own problems and to get some inputs regarding their level of comfort desired.



Video Depiction



a. Sitting in to the seat



b. Opening of door latch



c. Stepping out of the car door



d



e



f

Shown are some of the movements captured during whole of the action during ingress and egress.



Software simulation of body movements

By breaking of the every movement of body action into slots the deficiencies were chalked out

Ingress - Movement sequence

- Reach out for the latch
- Turn it up with fingers and thumb
- Pull out the door with one hand and hold car body with other
- Put one foot on the car floor
- Slide your body in
- Pull the car door in

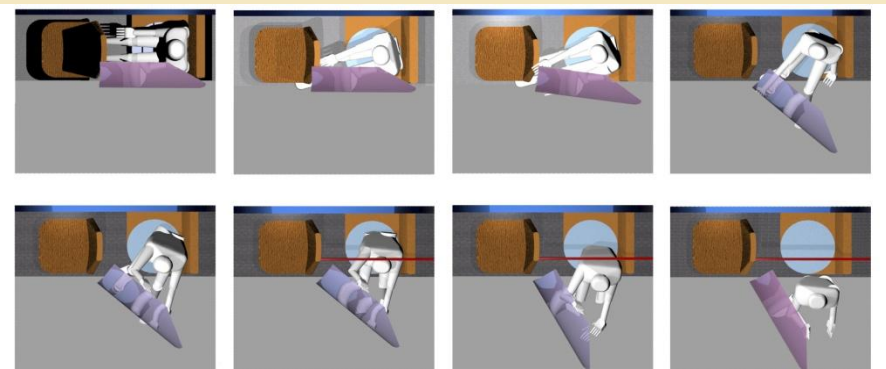

Egress sequence from the opening of latch to moving out of the car as depicted in the adjoining images





Sit - Movement sequence

- *Adjusting:*

- Shifting backwards for lumbar support

- Push using legs/ hands

- Hands grip on seat cushion for pushing

- Seatbelt strapping

- Resting arms on the armrest of door side
- Adjusting the personal belongings to proper place
- Extending/ retracting legs under front seat



Movement Analysis contd.

Egress - Movement sequence

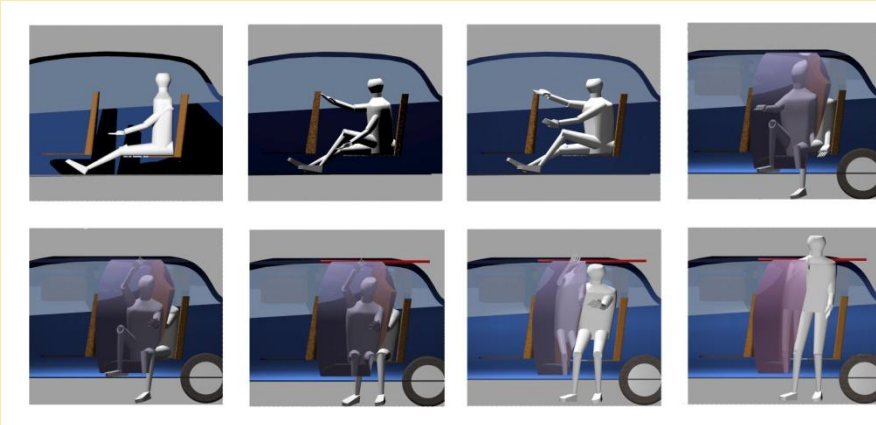

- Moving forward by pulling body using legs/ hands on seat
- Twisting slightly
- Opening door latch
- Jerking the door out
- Meanwhile also grabbing seats
- Turning outwards the door
- Coming to edge of seat for moving out
- Grabbing door with one hand and seat with other
- Pulling the body out
- Holding door for complete support
- Turning and closing the door using knob



Product Brief

The priority of working was finalized from the analysis as -

- Seating:
 - Bottom rotation
 - Backrest inclination
- Hand grip
- Head support
- Foot Rest
- Hand rest

Seating:

The main cause of strain for the elderly people is that they have to really push hard for coming out of the vehicle since the exit is at 90 degree to the seating position..

Another matter is the lack of adjustment to the rear seat back rest. Due to which the back muscles get strained.





Hand grip:

The elderly specially require some gripping object to come out and move into the vehicle thus the need for it.

Head support:

Their pattern of spending time as either sleeping or reading and need to help them in keeping with the correct body posture, the provision of adjustable head support is proposed.

Foot Rest:

The elderly people face numbness in legs due to maintaining of same position and lack of movement when they are traveling. Thus to eliminate this and to provide some form of exercise the foot rest is introduced.



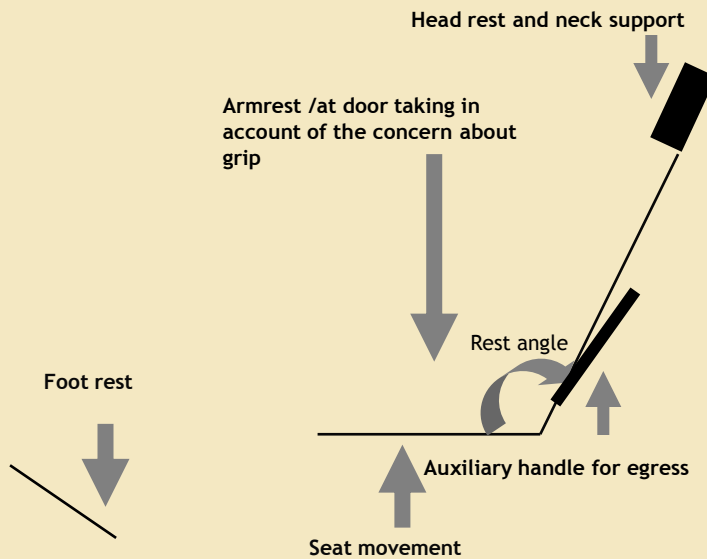

Fig. Specification of scope

Hand rest:

It is already an established concept which is made mandatory for providing more comfort and security by doubling as a gripping object.

In addition to all of the above the system has to be unobtrusive since at this stage there are some process which are taken for granted i.e. due to prolonged use of the vehicle there are some intuitive movements which are difficult to change.



Niche areas:

Some of the problems which are taken for working on are as -

- Seat position is static
- Variable support at the door as locus of point where hand moves
- Force required to move, in and out.
- Adjusting the body after moving in
- Gripping on to someplace while close the door
- Back pain due to posture
- Twisting of body during ingress and egress
- Provision for foot resting / movement during travel



Idea generation :

Hand Grip

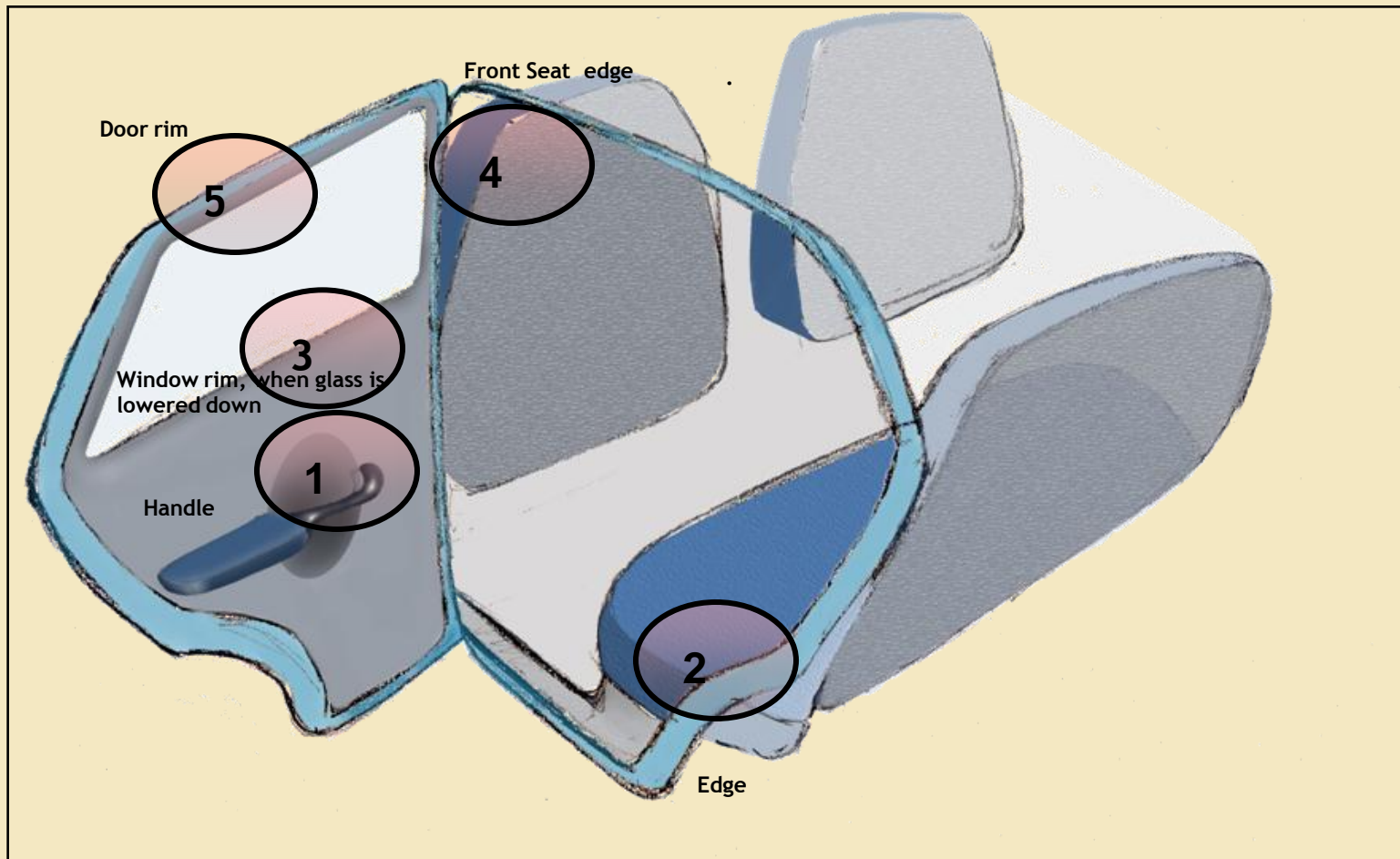
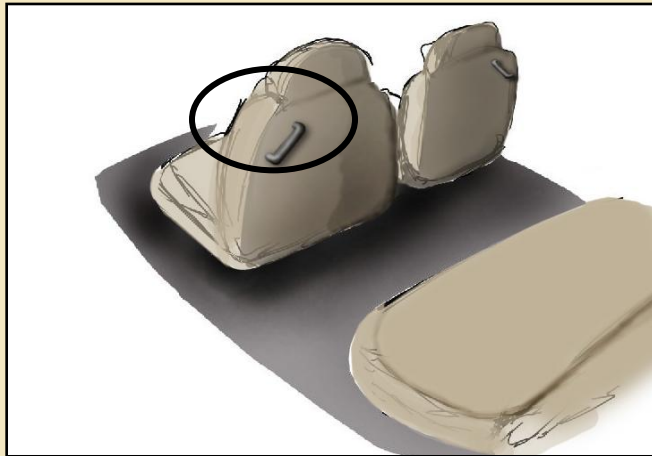

Fig
Different supporting areas concerned with process of ingress and egress





Grab bar

Idea generation : Hand grip -

The generation of idea sketches started with keeping in mind about providing the new provision for solving the aforementioned problems.

During the ingress/ egress there is a need to have a support for pushing pulling the body some time for alignment to the door or with the seat. Hence the need for grabbing was taken care by the provision of a grab bar on the back of the front seat.

So that, when the person wants to come forward as for ejecting himself out, the action is supported by this proper accessory





Auxiliary handle and grab noose

Idea generation: Hand grip

Auxiliary handle and grab noose

Grab bar extended

Here the ideation was done to have look at new ways for providing support during ingress and egress when hands search for some object to grab on.



Grab bar extended

Either the door rim or side lining of the car body are the most probable areas for leaning on to.





Support by the turning rod

Idea generation: Hand grip

Mechanism of operation by the person was explored to find out the effectiveness of this solution.

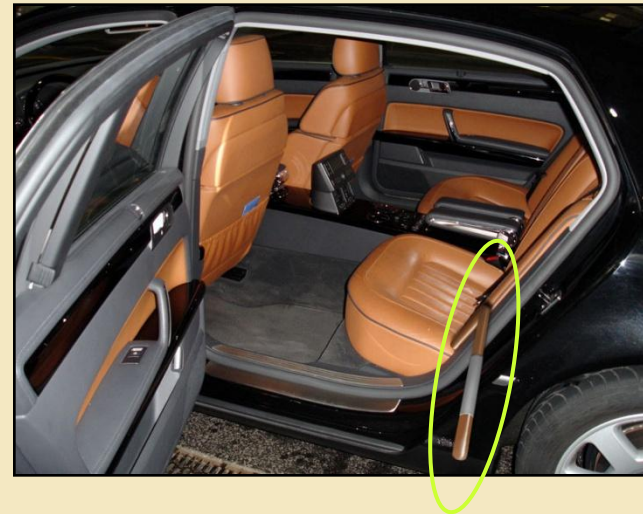



Fig a

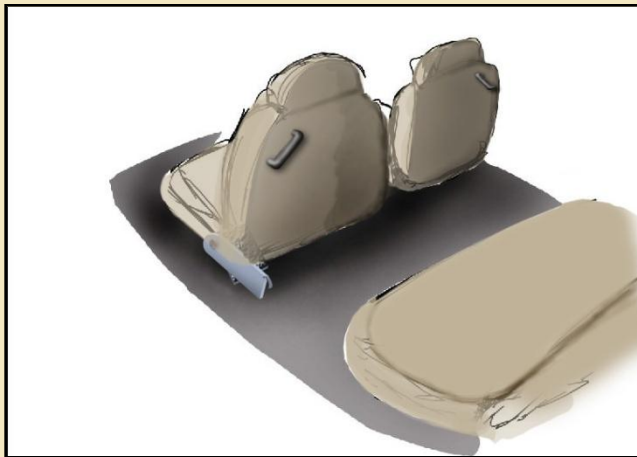

Fig b

Idea generation : Foot rest

Here, the provision of providing support to the feet was explored. During travel, the numbness of feet is experienced by these elderly travelers.

Cramping is also noted in some cases

In form of retractable foot attached under the front driver/ co-driver seat provision for support is made so as the strain on the calf muscles and knee joint is lessened. And since the foot rest is retractable it could be used depending upon the requirement.

The foot rest is supported on chassis floor underneath.



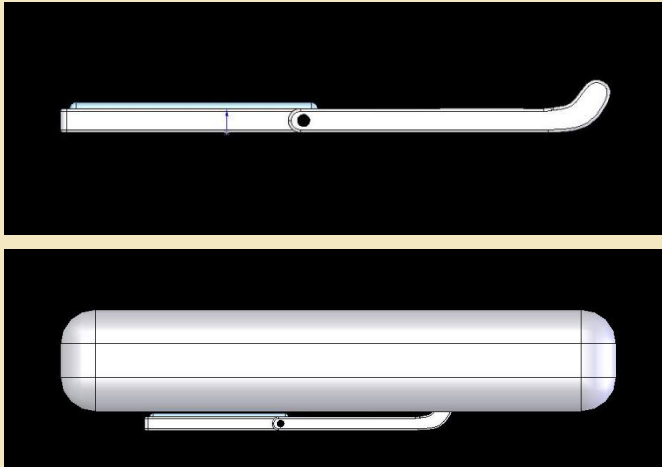

Retractable underneath footrest

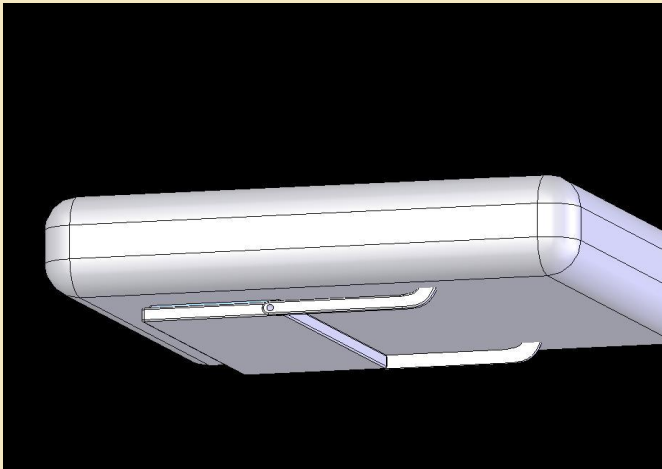

Fig b

Idea generation : Foot rest

Here the foot rest was made attached under the front driver/ co-driver seat bottom so that the space requirement for the legs is not tampered with.

Also, this arrangement provides for the maximum of the flexion of the legs under the front seat for a taller person.

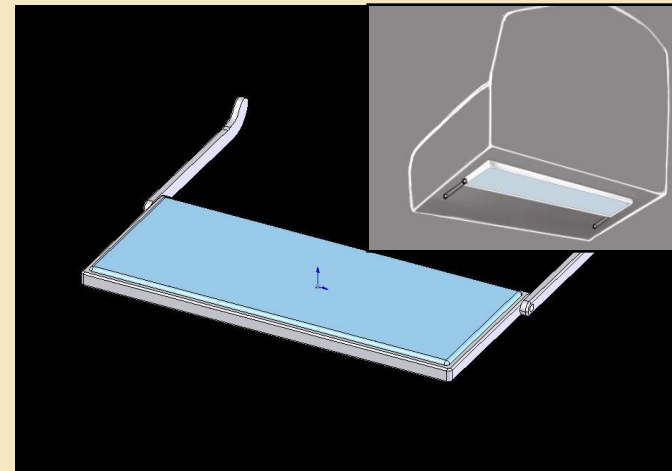

Fig c



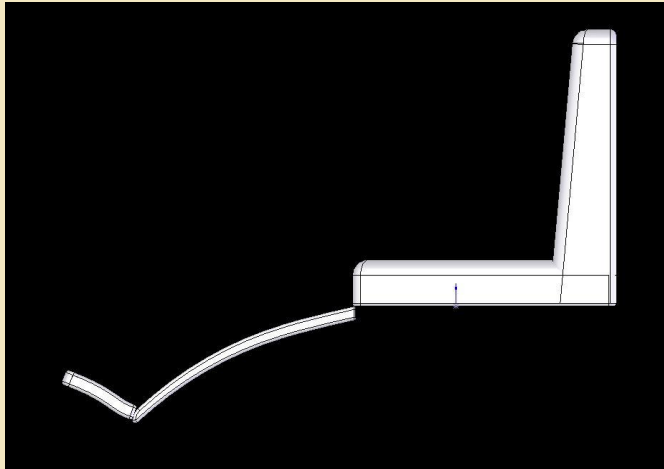
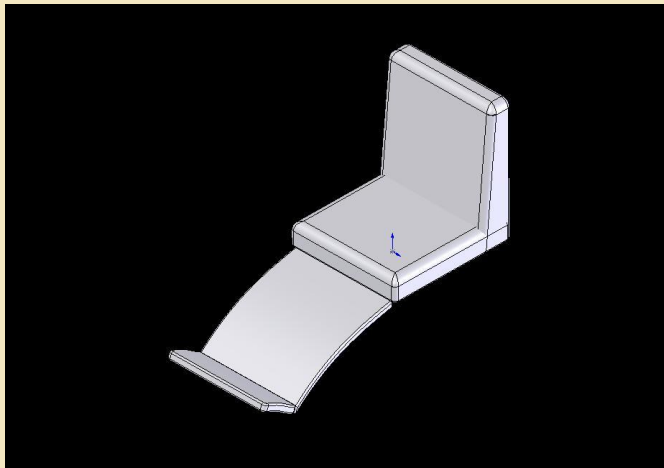

Fig. The combination of footrest and calf rest



Idea generation : Foot rest

Now one of the concern was making for the rest for leg as a whole not only the feet. So, the foot rest was extended as calf rest also which was to be retracted under the rear seat itself when not in use.





Fig
Head rest fused with movable back rest, sleep support is static

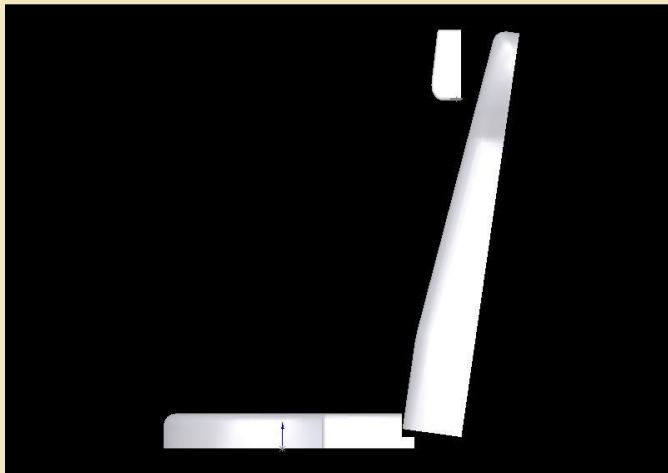

Idea generation : Head rest/ neck support

Now, the focus was for the provision of head support which should also provide stability to neck during sleeping. Thus side are extended to make up for the support for that purpose

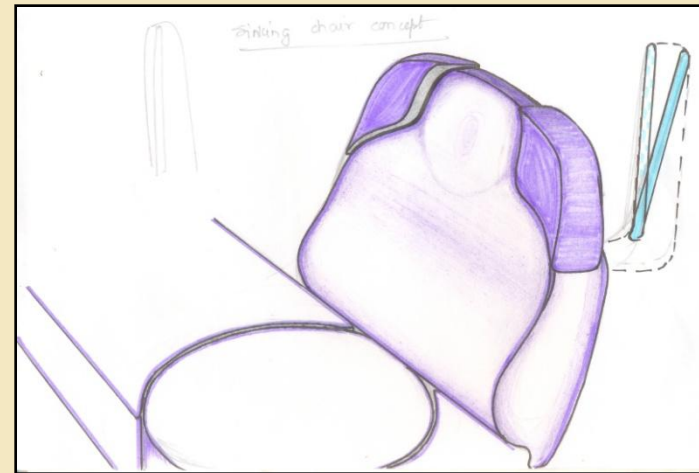
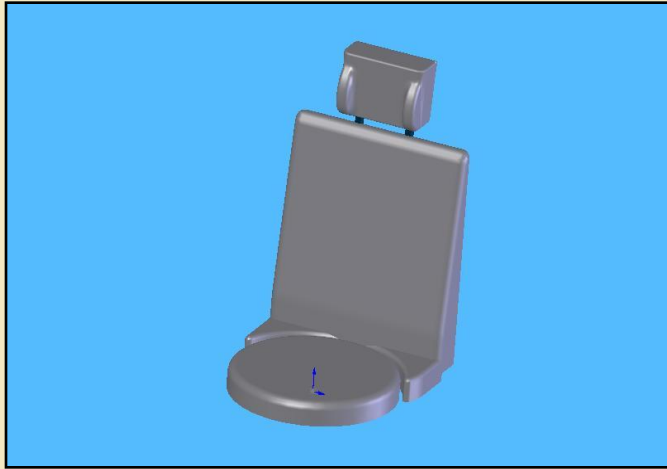

Fig
Back rest movable, head support elevated





Idea generation : Head rest/ neck support

Now the same idea of head support which provides stability to neck during sleeping was explored further in form of inflatable balloons, strapped side constraints and one was to make provide height adjustability to compensate for different body structures .

Head rest adjustable in height along with side support

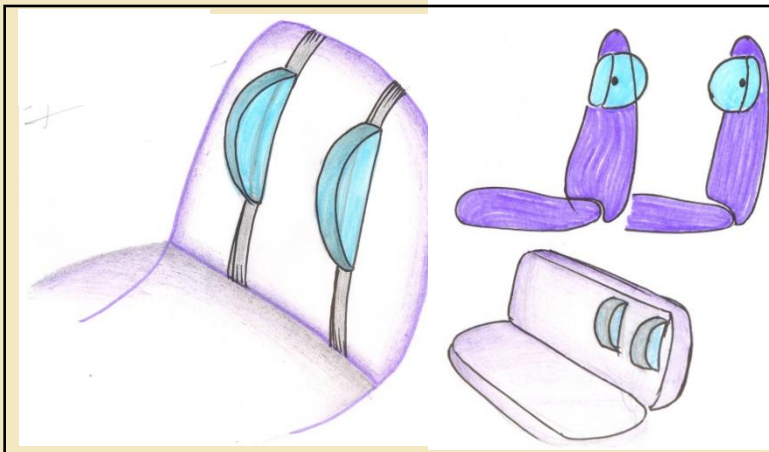

Strapped neck support

Rotating disc

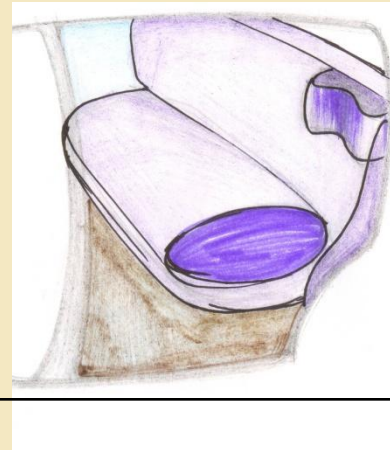

Cushioned head rest



Inflatable balloon





Back rest at relaxed position

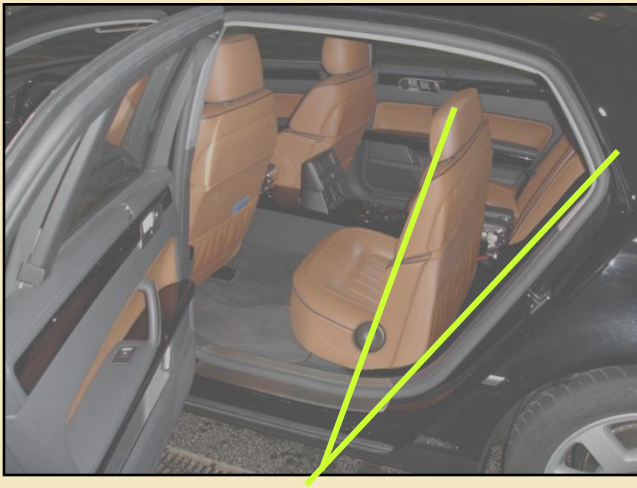

Back rest at erect position

Idea generation : Seat (Linear and angular motion)

Here the area of focus was the rear seat movement where the back rest moves forward as well as rotates at pivot point thus helping in pushing forward while going out or sitting in. So that the unnecessary effort on back muscles is reduced.

When in relaxed posture the back rest is inclined at obtuse angle to the horizontal but when the user wants to move out the backrest rotates to make it come perpendicular as depicted in the image.

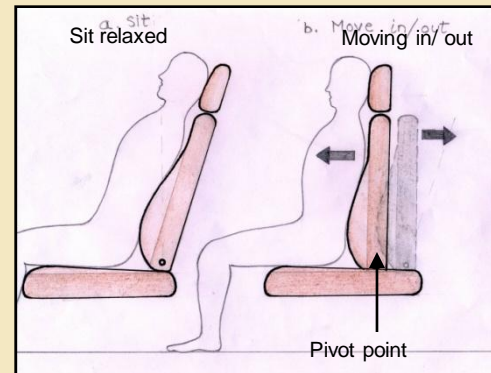

Representation of backrest motion



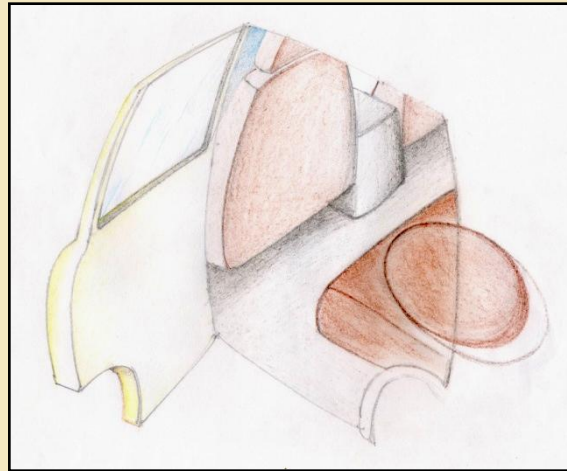

Idea generation: Seat Rotatory motion

In this proposal, the bottom seat i.e. the area which remains in contact with the buttocks is used to enhance the comfort level at the time of ingress and egress by reducing frictional force between legs and seat cushion.

The positioning of rotating disc

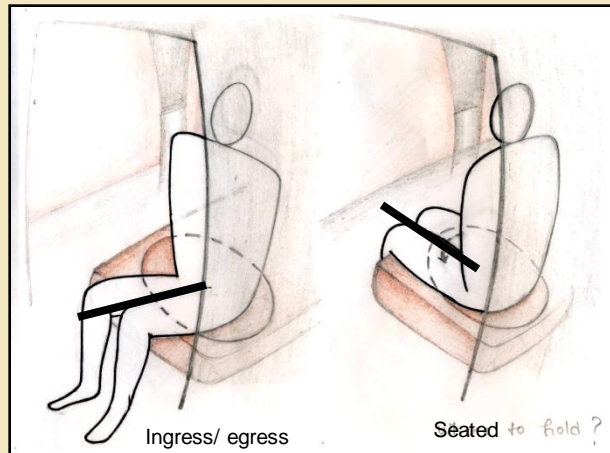

This system reduces the effort on back, leg as well as arm muscles during twisting, as required while ingress and egress.

Usage pattern of the seat



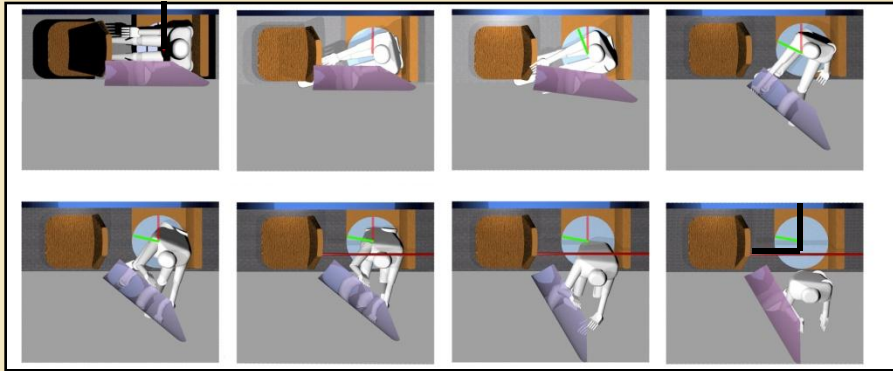

The extent of rotation is tried to analyzed with the help of simulation of motion during egress.

As depicted the rotation varies from extremes of 0 to 90 degrees in between the normal seating and egress.

The angular rotation of the disc



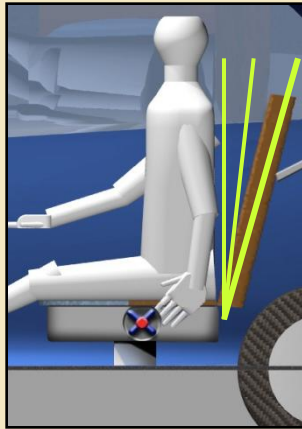

Back rest at relaxed position

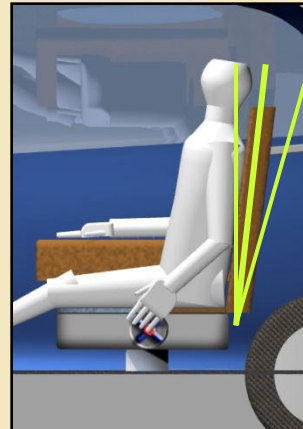

Back rest at erect position

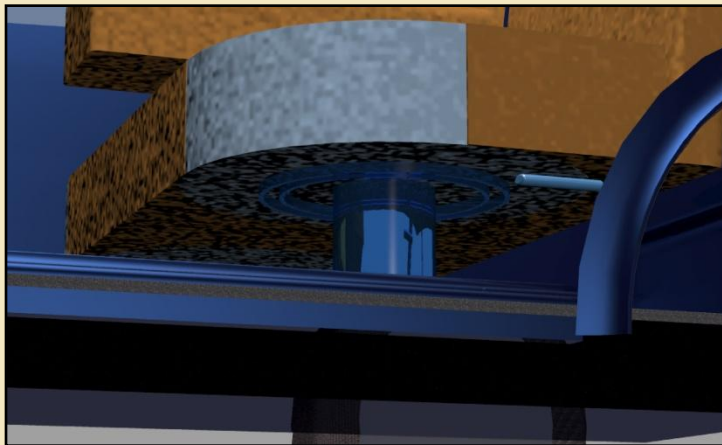

Rotating pivot mechanism as on the underside

Concepts:

The concept developed were not as standalone type but differentiated from each other in case of

Rotating Seat

Rotating seat along with slotted adjustable backrest

- Bottom support desired rotating angle 90 deg.
- Locked when door is closed
- Becomes free to rotate when door latch opened
- Rotates on the central pivot pillar
- Back rest is adjustable from 90- 110 deg.
- Control for that is provided at the lower door side of the rear seat
- Slotted motion is given to rotated it backward and forward both for controlled force
- Similar mechanism used for this backrest rotation as of used in co-driver/ driver seat



Concept Evaluation User feedback



Going to be seated



Just started to move out



Holding on the pillar to support moving out



Getting up from the seat



Moving one leg forward to get up



Bending out to make egress



Concept Evaluation User feedback contd.

During the testing with the working rig, two users were requested to simulate the sitting as in the car. Pillar support was provided in form of the wire frame.

Dimension of the various components were reference form the Indica car like entrance spacing, leg space and head room.

The rotating mechanism was found to be feasible and more helpful in reduction of physical stress to the users. As it provided some relief to the turning movement.



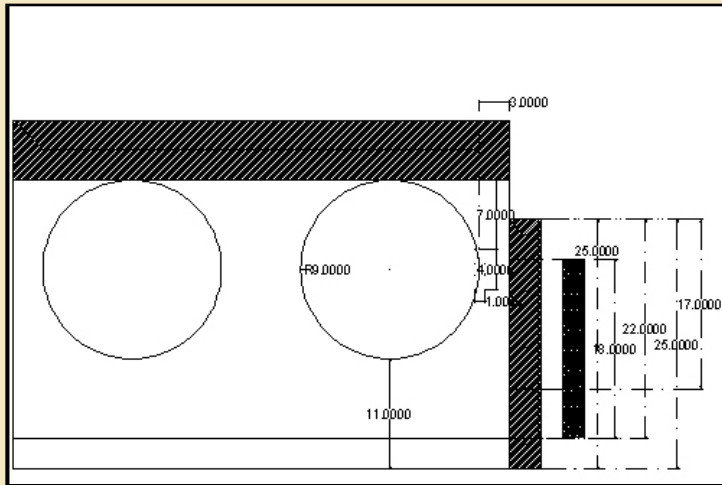

Top view seat and door dimensions

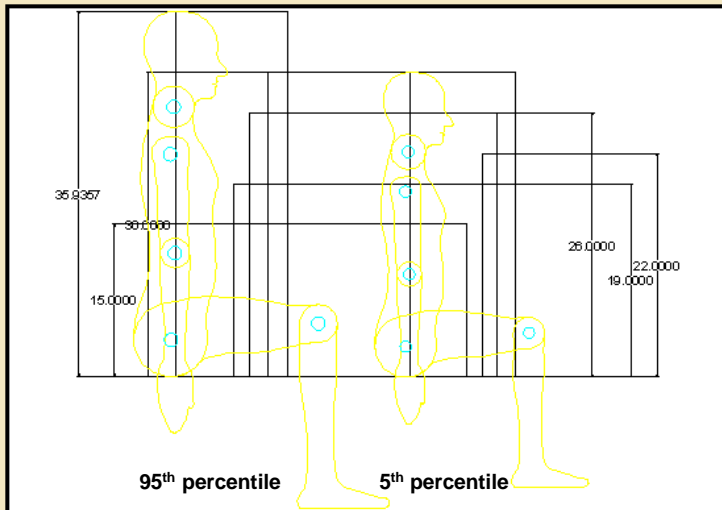

Backrest height requirement

Concept refinement

After evaluation the concept was further developed regarding dimensioning clarity, positioning and settlement along with various components

The height for back rest is taken to be equivalent to the cervical height of 95th percentile population.* So that the 5th percentile height person may also be able to use the same comfortably. Compensation regarding the head support is made in the subsequent stages.



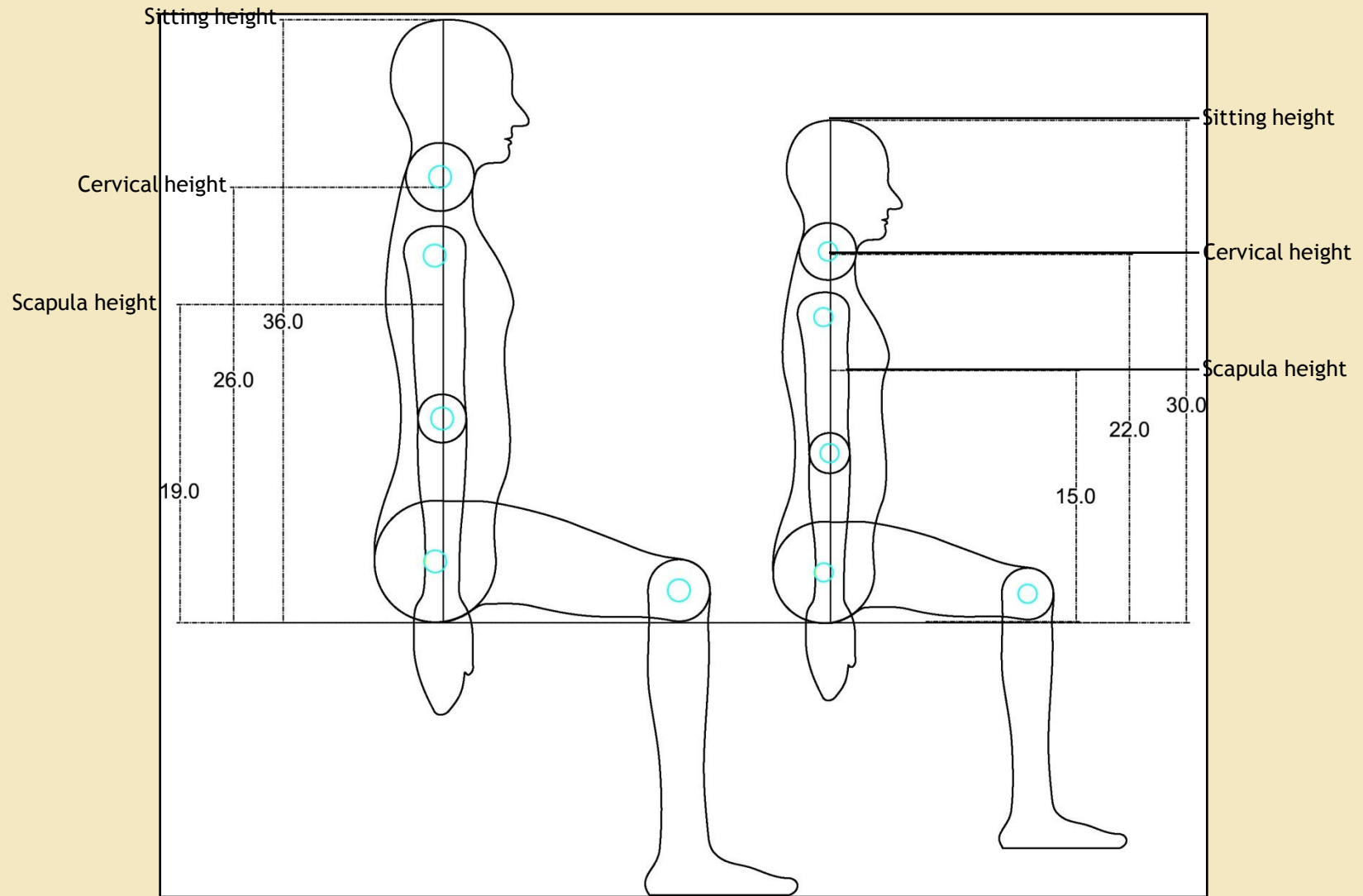

Fig 14.1.3b (enlarged)
Backrest height requirement

*All dimensions are in inches



Location of seat in the car

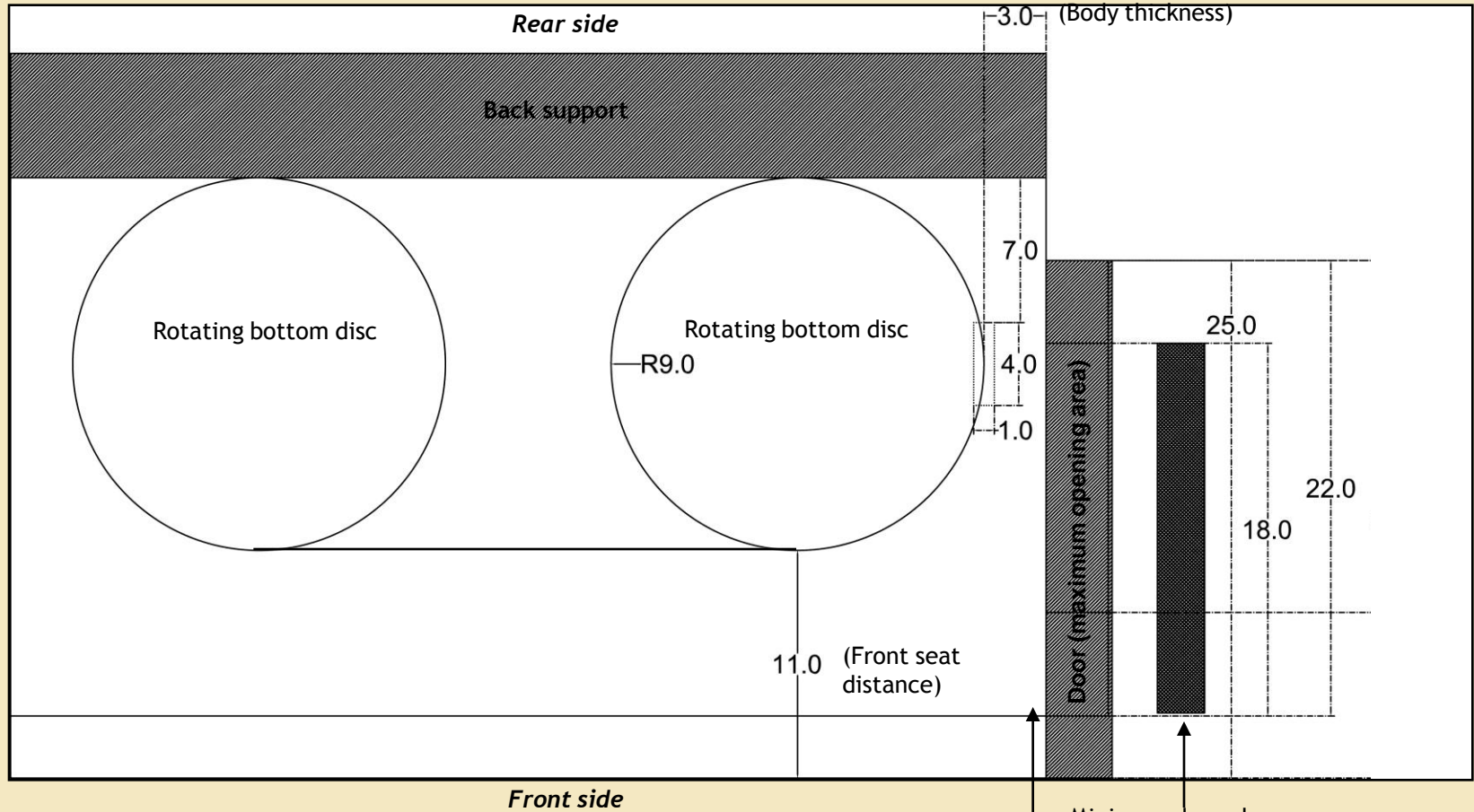

Fig 14.1.3a (enlarged view)
Seat as located in a car

B pillar position
(Door edge)

*All dimensions are in inches



Concept refinement

The basic chassis was required for reference to the concepts, in this case Indica was kept for reference. And further details were worked out accordingly.

Some basic dimensions as measured and used are

- Leg room - 13"
- Back support - 26"
- Bottom seating - 18"
- Seat width - 50"
- Door height - 45"
- Door width - 35" (max.)
- Door width - 25" (min.)
- Seat height - 13-16" (varies with cushion thickness)
- Wheel diam. - 15"

**Concept refinement:
Location of seat in the car**

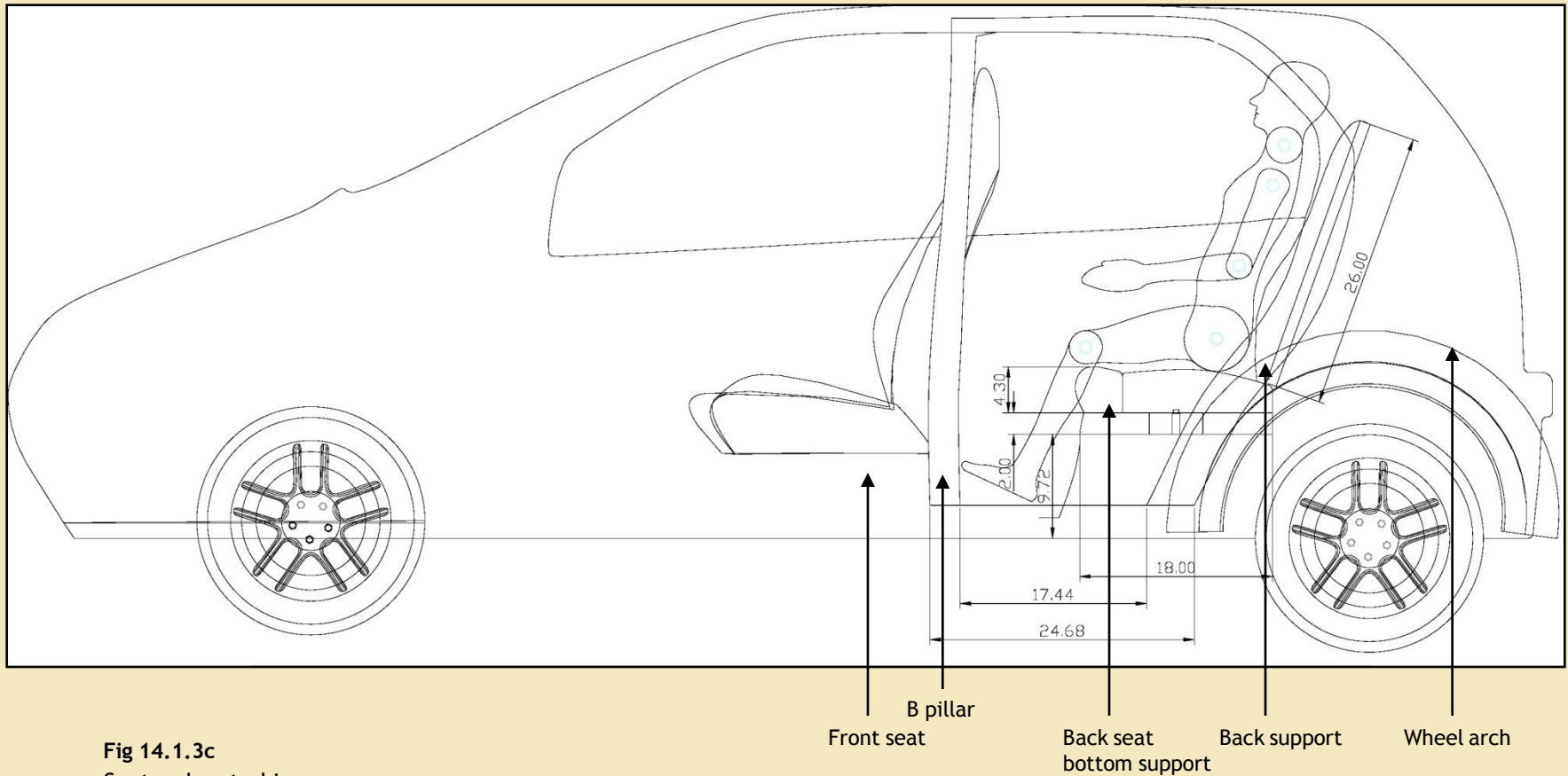
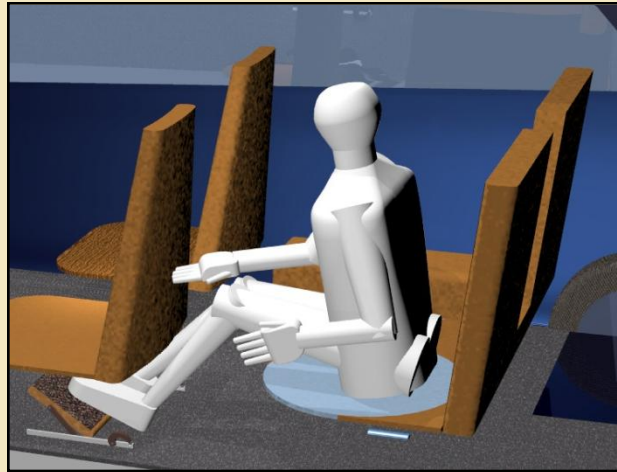

Fig 14.1.3c
Seat as located in a car

*All dimensions are in inches



Location in car

Concepts:

Foot Rest

Here, the functioning of foot rest was explored

- One time adjustment regarding horizontal distance from the rear seat, slides on the guide rail
- Switch pressing for making it lift up in working position

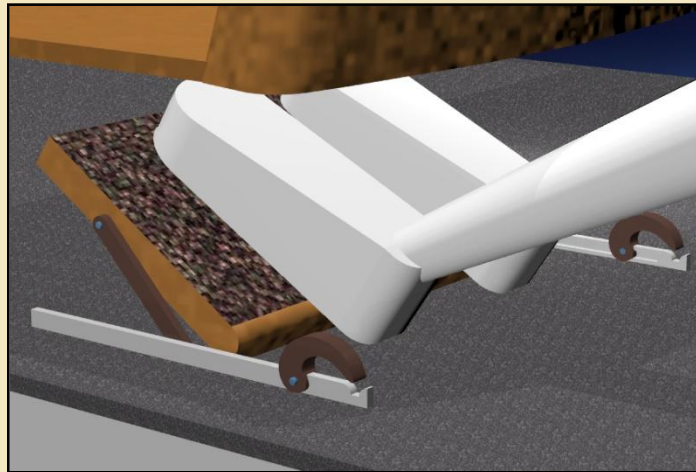

Feet position on the rest



Moving one foot to operate

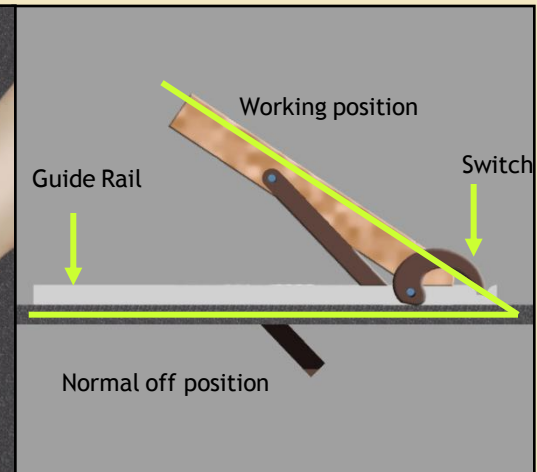

Detailing out





Location in car

Concept Evaluation User feedback

The plywood footrest was made and kept in the interior of Indica itself at different angles and position. Then study was carried to find out the extent of comfort achieved through it.



Feet position on the rest



Exploration best suitable position





Joints position in the car with
foot rest

Concept Evaluation User feedback

During the testing with the working rig, user was required to sit with foot rest put underneath the co-driver seat and it was found that -

- It provided some rest to the sole with optimum angle of 15 deg.
- Space reduction was occurring due to it,
- Along with reduction in the knee angle thus increasing stress
- Variation in front seat movement was hindering the use of foot rest
- Thus, creating a degree of dependency on the front seat occupant



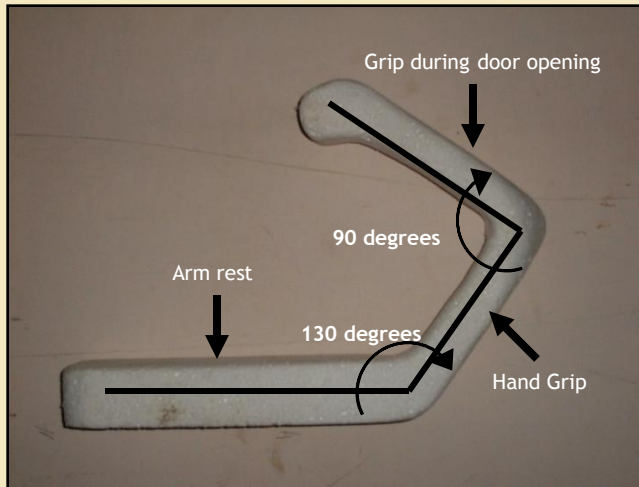

Location in car

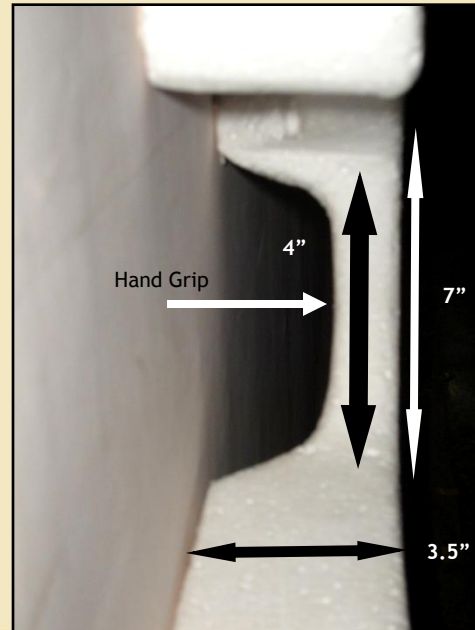
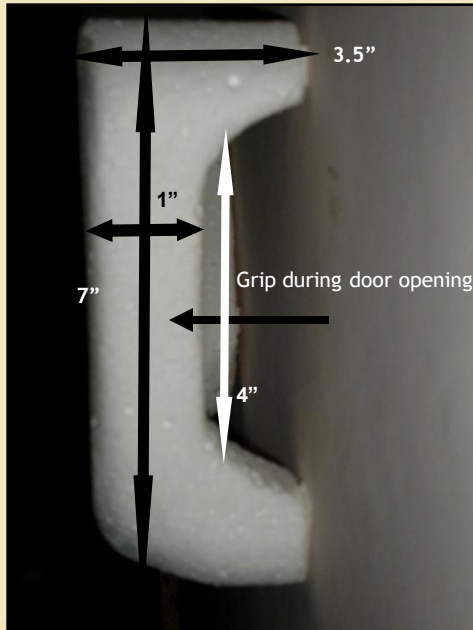

Concept

Hand support

- It provides rest to the forearm
- Provision of holding in natural position of the wrist
- Gripping for opening the door and during emergency
- Support during opening of the door

This concept was to get the elderly have a comfort level as well as the security feeling

The natural wrist position during grip has to be maintained without causing unnecessary twisting or bending.

Upper bar is provided to make up for the force required during egress when some sort of support is needed to grip for standing up from the seat level.



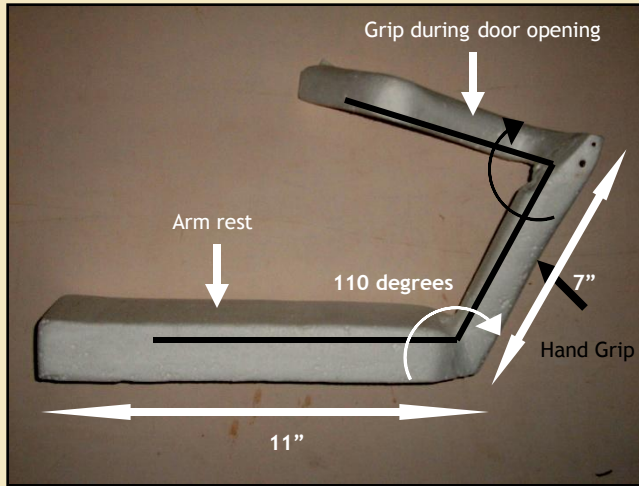

Concept

Hand support

- Here the angle of middle and upper bar was changed to know the change in comfort level provided by it.
- Also the upper bar is rotated at an angle with horizontal to provide a better grip at the moment the pulling force is exerted by commuter to come out of the car body rim level.

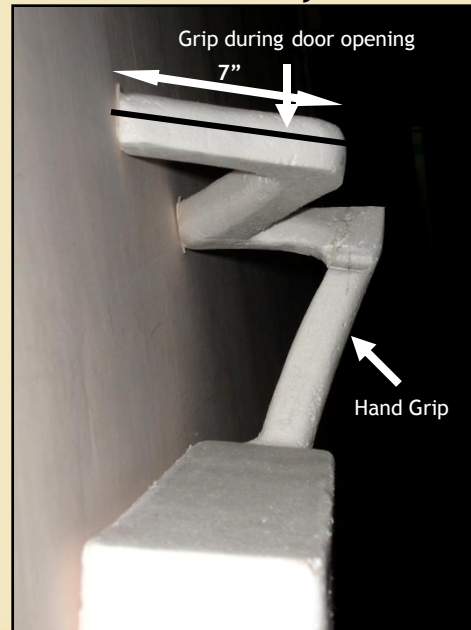
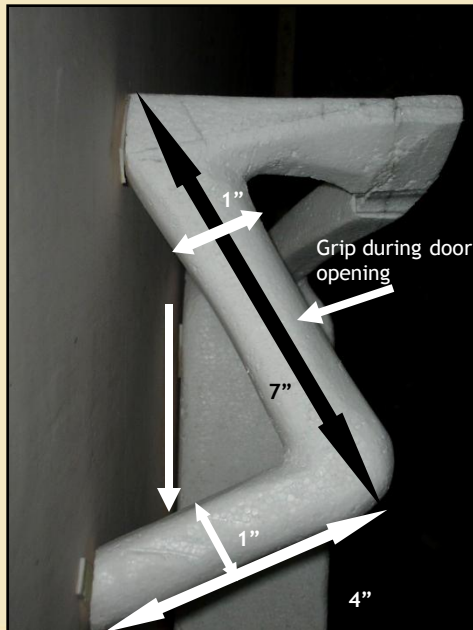

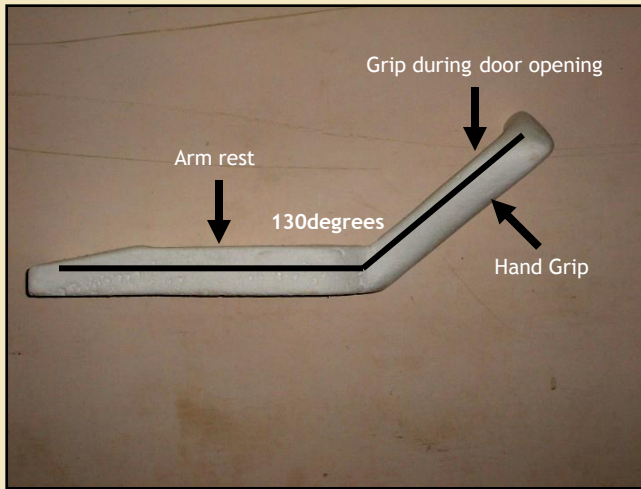

Concept

Hand support

- In this concept the main focus shifted to provide maximum comfort during the egress part.
- The upper bar is fused with the middle bar so as to create a cavity for grip itself

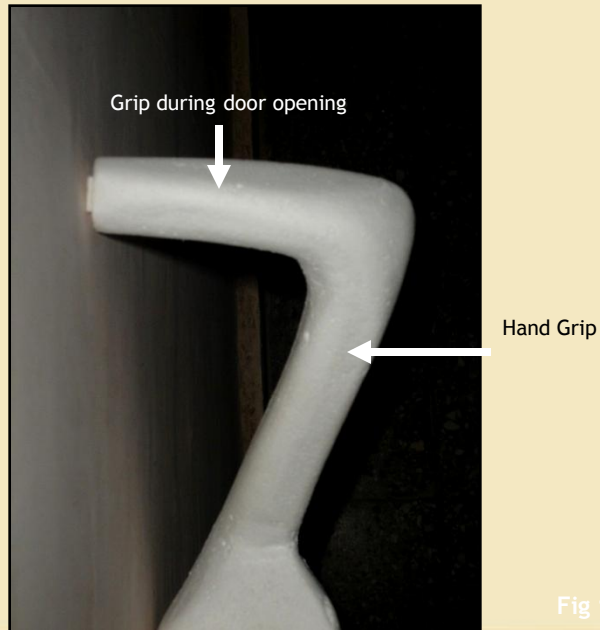
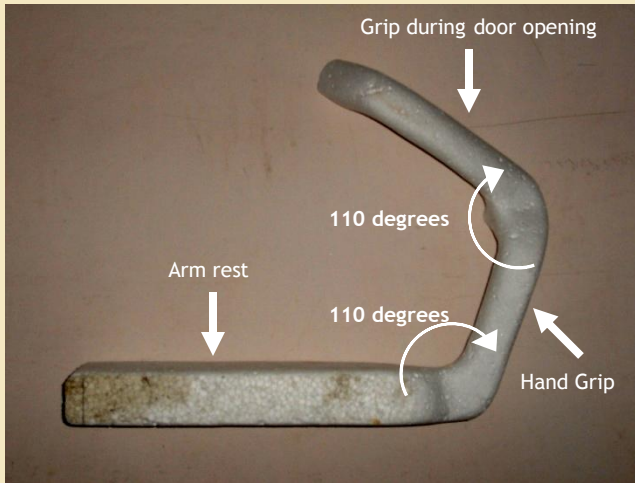

Fig 14.3.1c





Concept

Hand support

- In this concept the middle bar was tilted at the increased vertical angle as compared to 1st one so as to coincide with the natural posture of wrist .
- Upper bar was tilted with horizontal to amalgamate the provision for pulling for and load bearing during lifting up from the seat

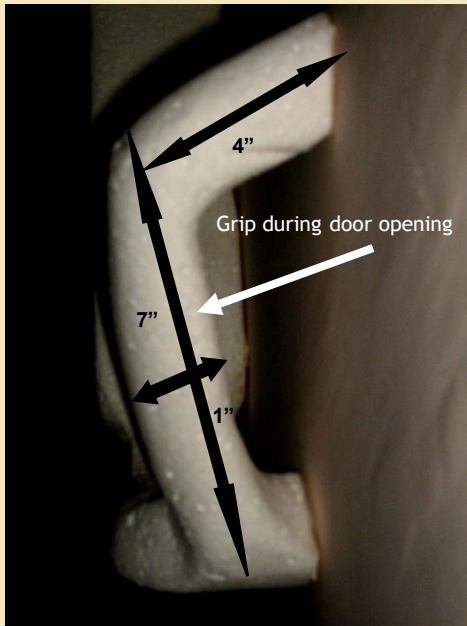

Concept

Arm rest finalized

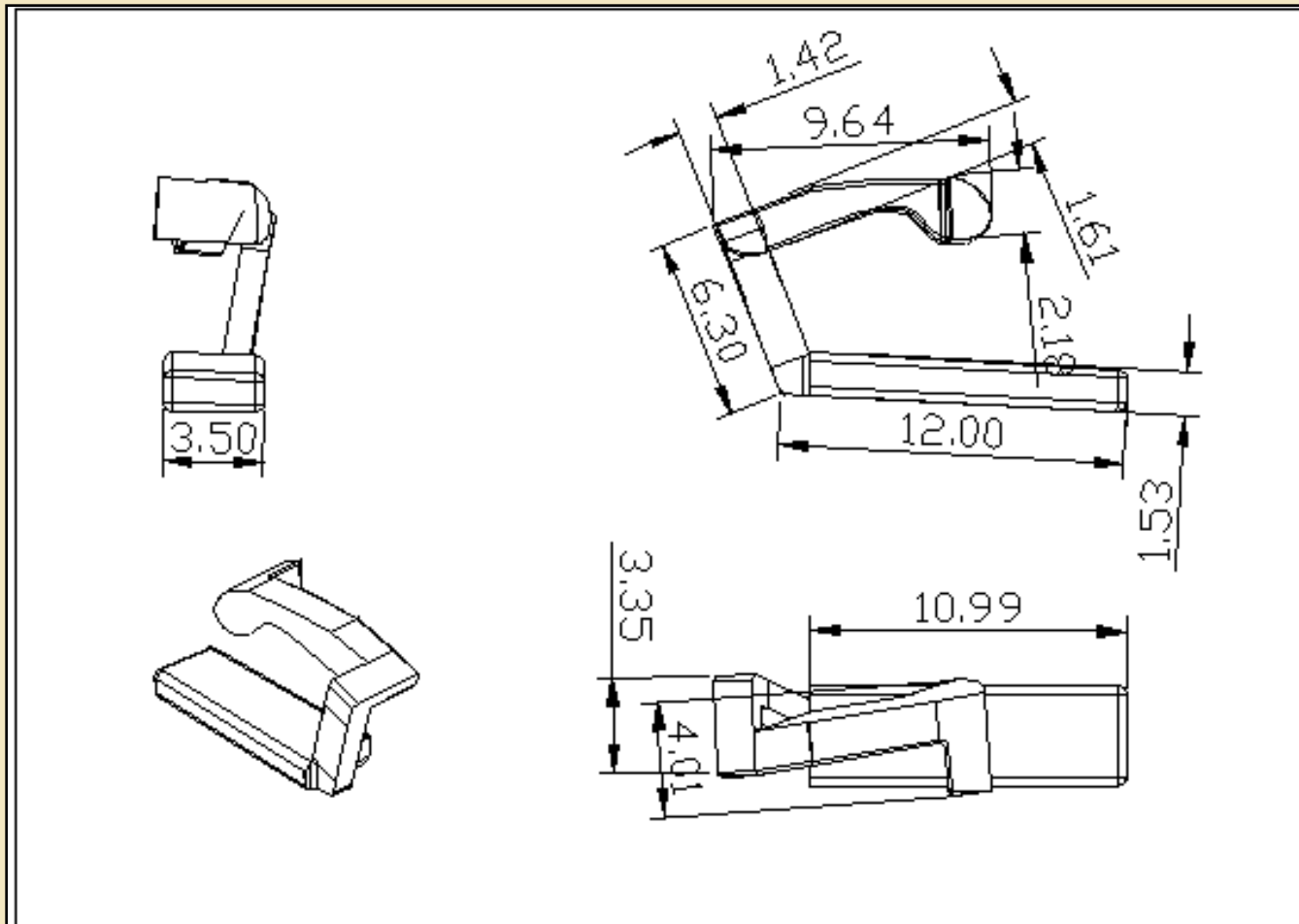



Concept

Arm rest

- It provides rest to the forearm
- Provision of holding in natural position of the wrist
- Gripping for opening the door and during emergency
- Support during opening of the door

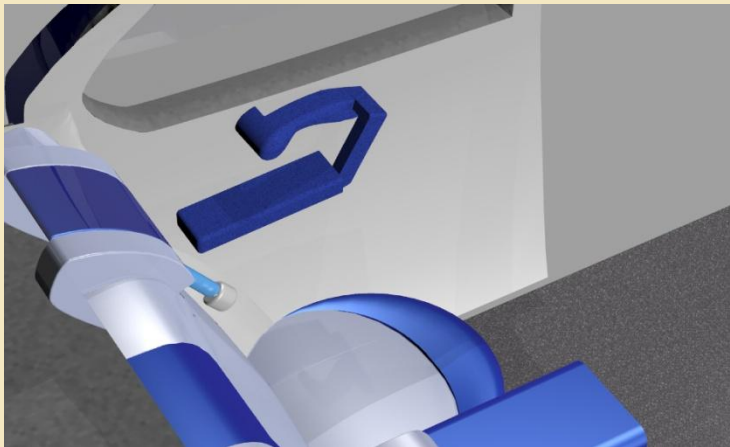

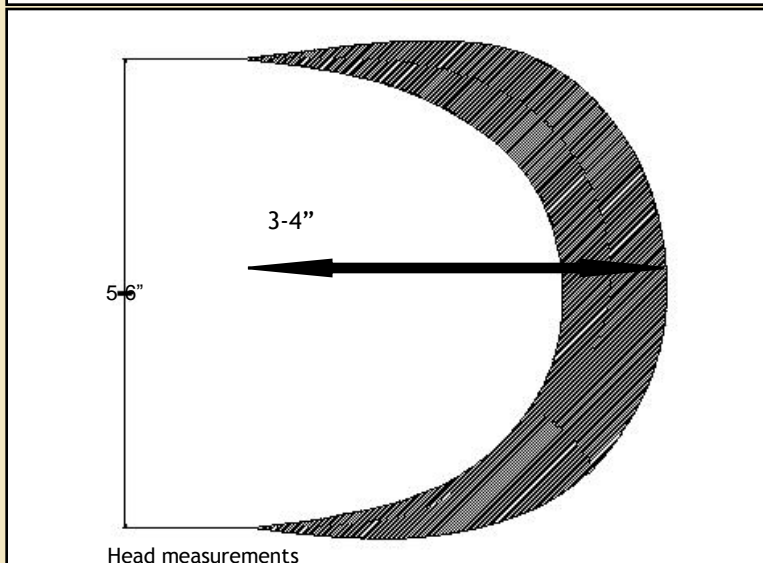
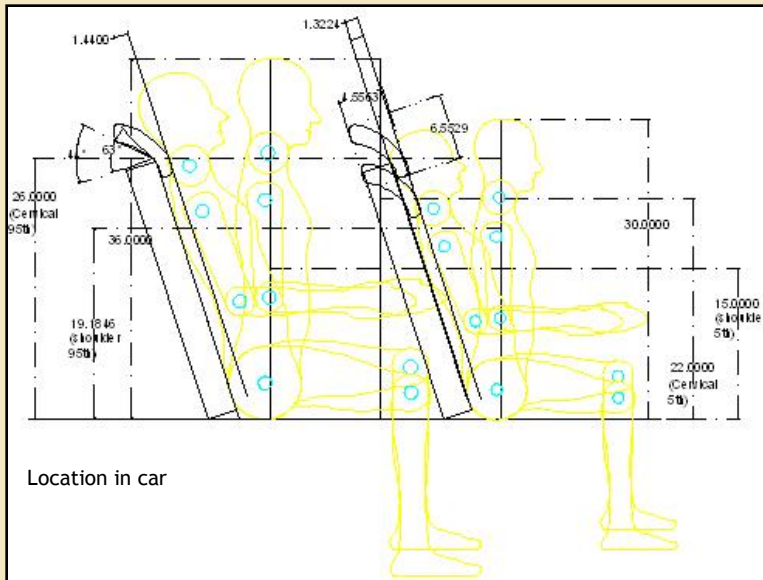

Concept

Head rest

- It provides rest to the cervical region
- Provision of keeping the neck in natural curved posture
- Since, sleeping is the activity which occurs most of the elderly people when they are traveling in their vehicle provision of some support inducted
- Normal indexing mechanism as is prevalent, employed for height adjustability
- Adjustability required for the head support and also the angle arrived for providing the natural posture for head resting
- Regarding the variation in sizes of head the shaded area as the difference in 5th and 95th of the sample.



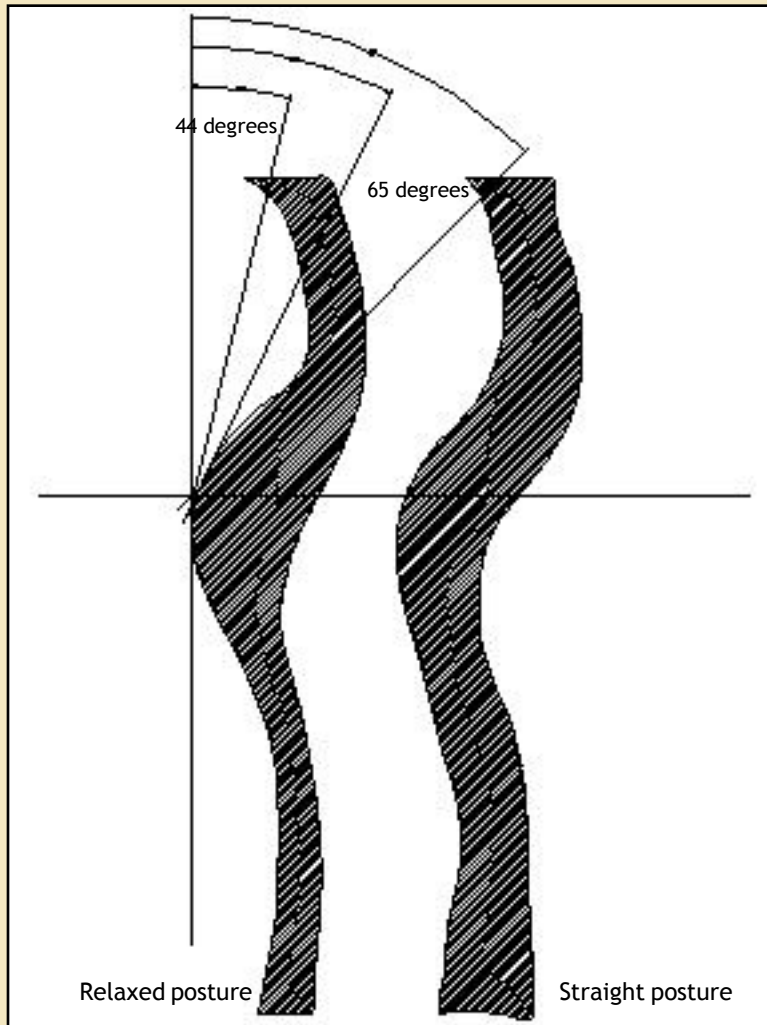

Neck/ head profile measurement

Concept

Head rest profile

- The adjoining figure shows the variation in spinal curves (at neck)of different people.
- The variation in angle may be in between 44 deg to 65 deg. Under relaxed and straight posture





Testing of mechanism



Concept

Head rest mock model

- The adjoining figure shows the simulating of the head support
- The flapping mechanism pivoted at a point is done with fixed number of slots



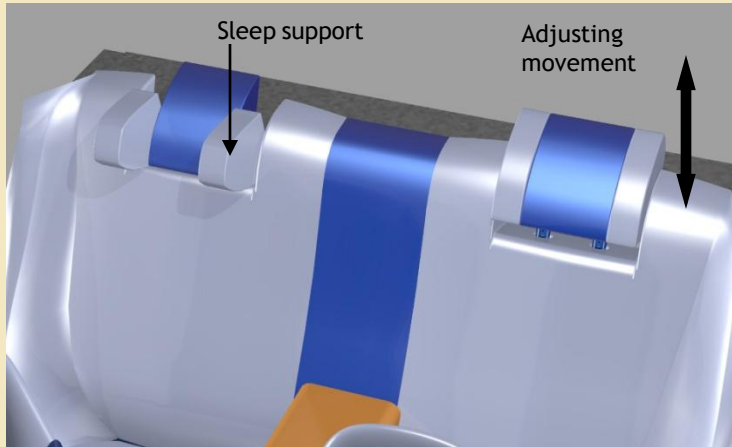

One of the seat's head arresting panels moved forward

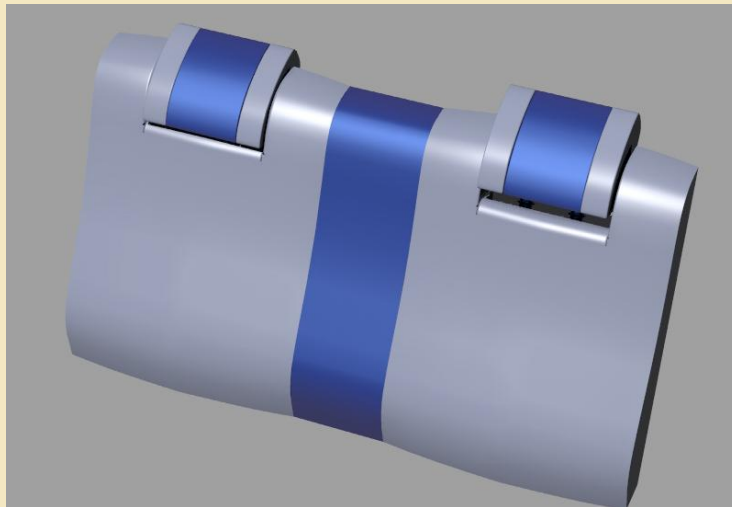

One of the head support moved for upward adjustment

Concept

Head rest renderings



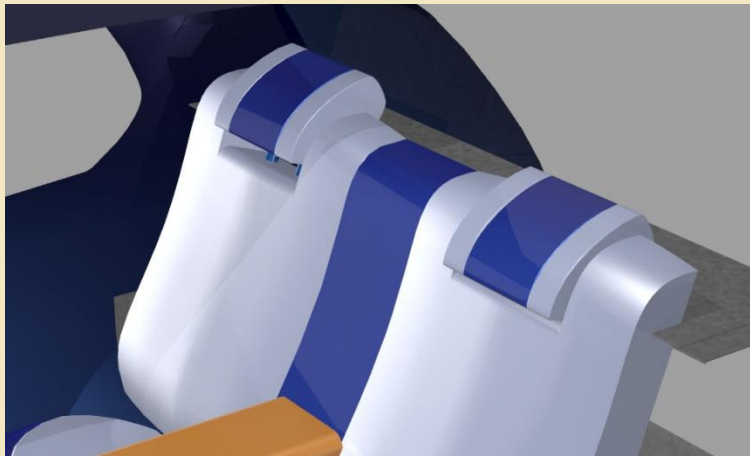
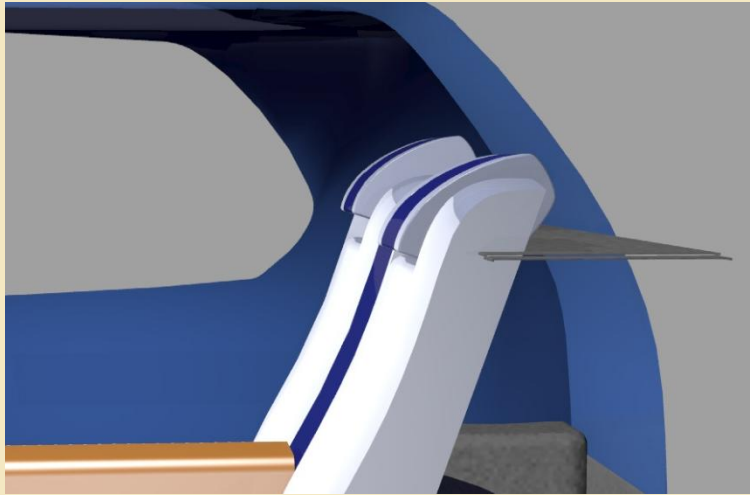

Concept

Head rest renderings contd.

- It provides rest to the cervical region
- Provision of keeping the neck in natural curved posture
- Since, sleeping is the activity which occurs most of the elderly people when they are traveling in their vehicle provision of some support inducted
- Normal indexing mechanism as is prevalent employed

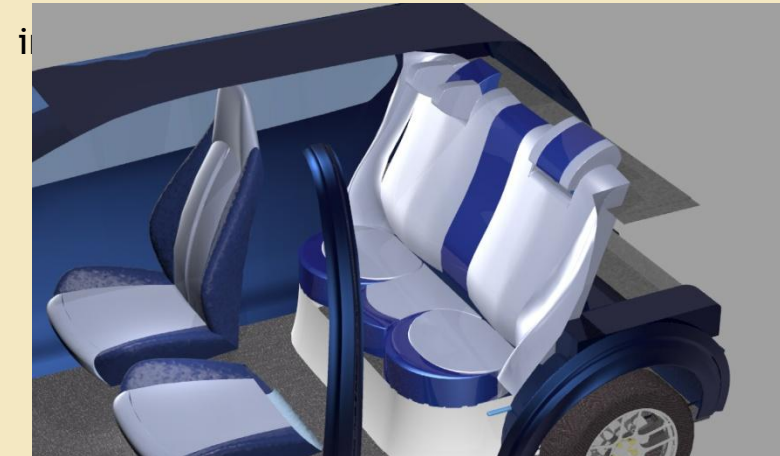

Concept

Head rest final dimensions

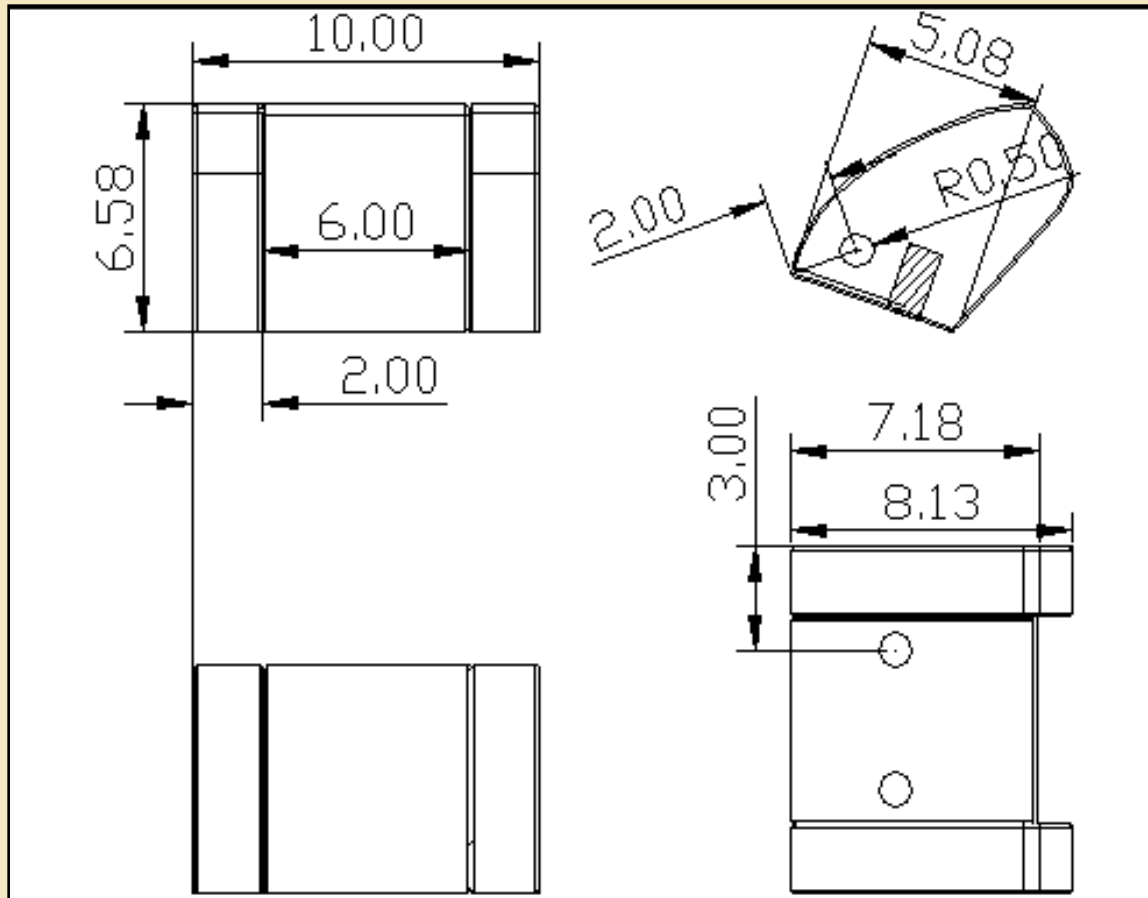

Neck/ head support dimensions

All dimensions are in inches



Concept

Auxiliary handle

- It provides support during egress
- In the normal position it remains rested with the car body
- At the time of egress the user pushes it up, so that it rotates and becomes vertical and self locks
- Then it does an outward rotation for serving the purpose of support
- i.e. it has tri axial motion in x , y and z direction

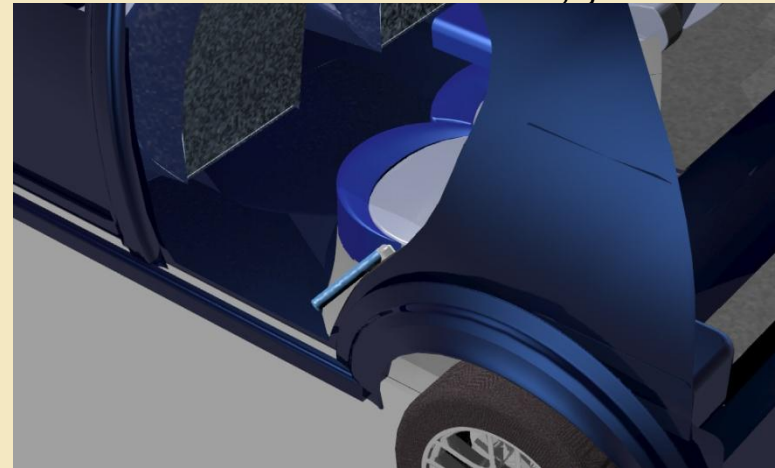
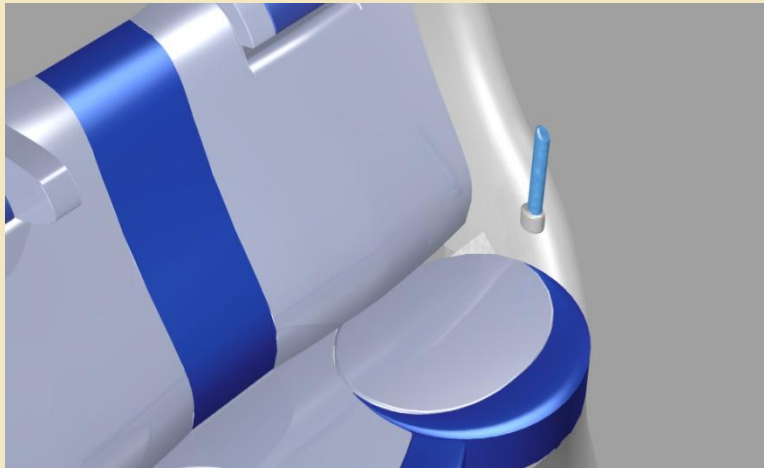
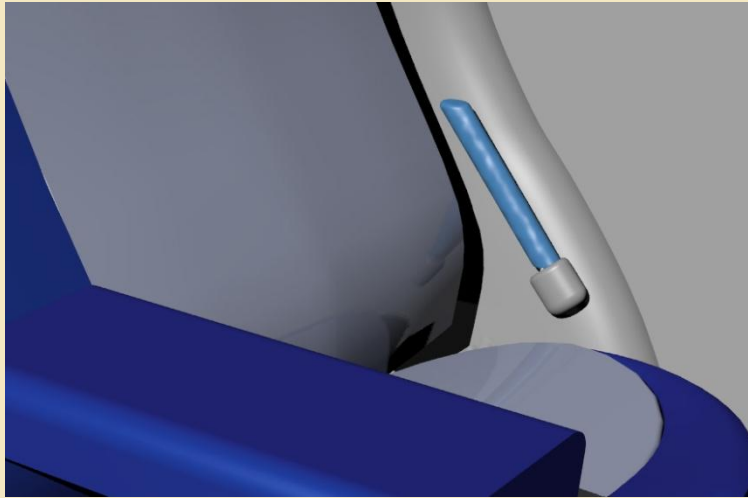

Concept

Auxiliary handle dimensions

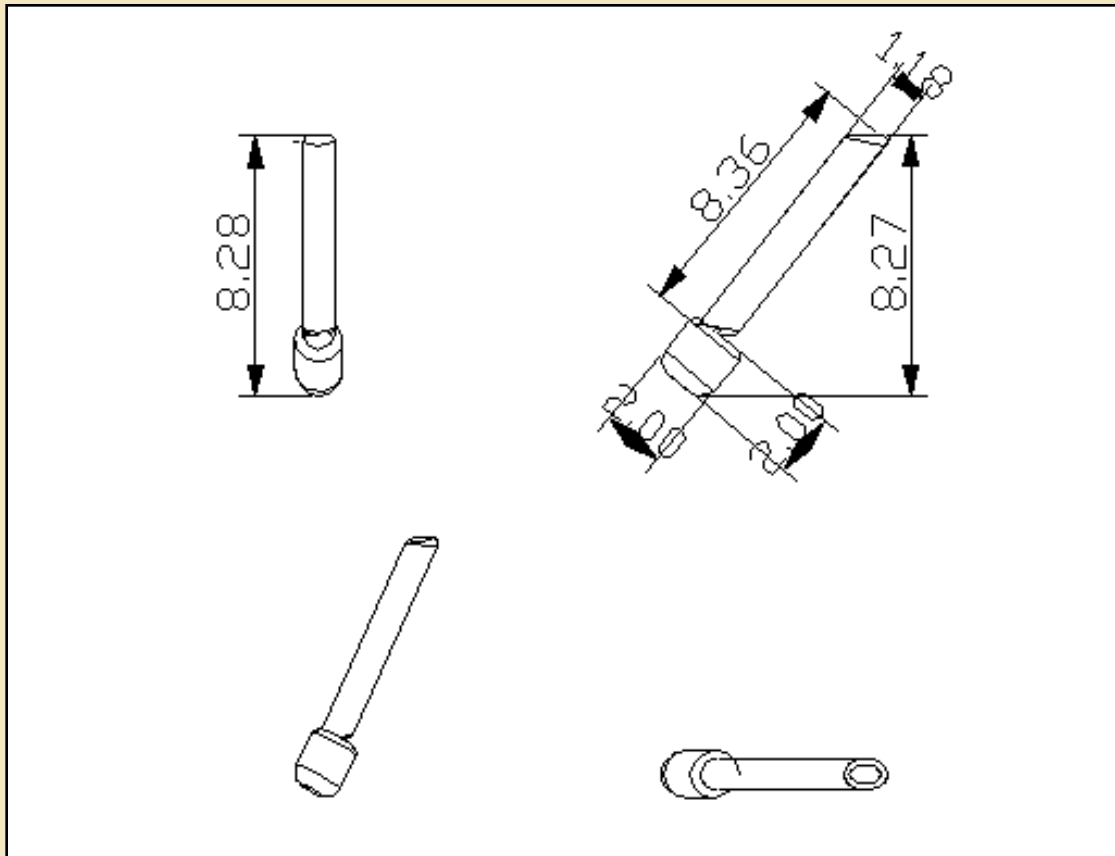

Auxiliary handle dimensions

All dimensions are in inches



Final concept





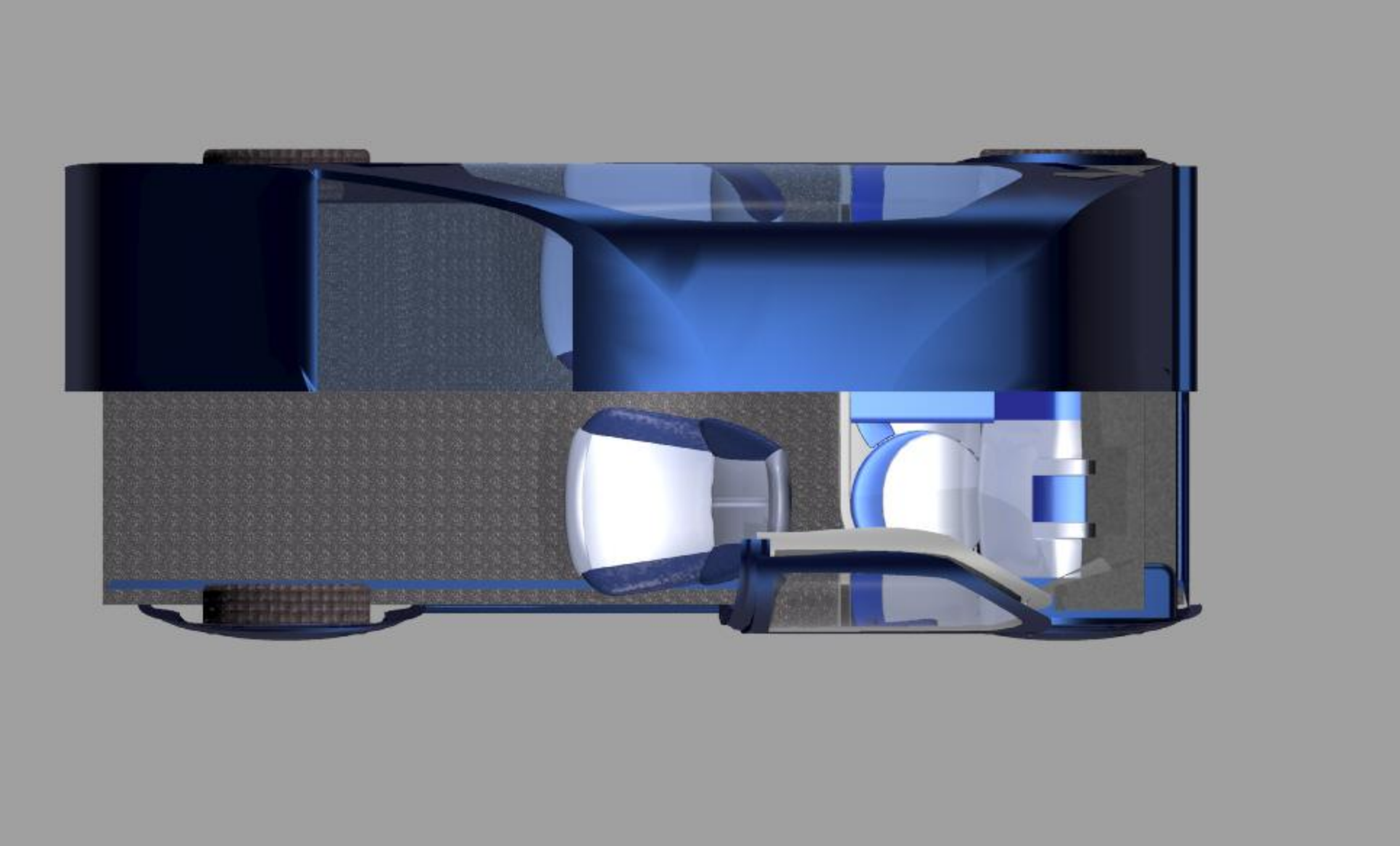

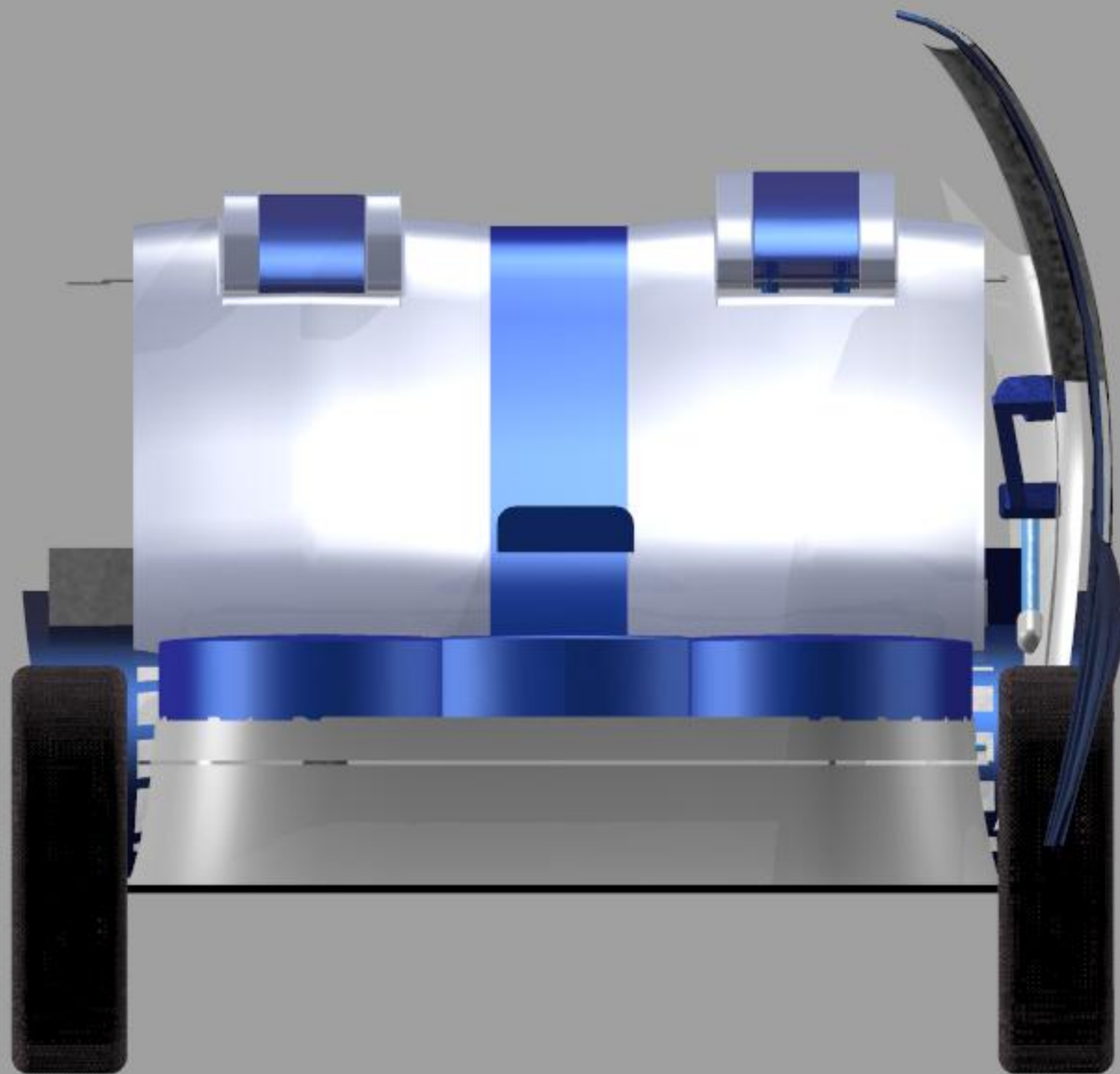



Model images









