

# Design Of A Household Dishwasher

By Vaibhav Gadade

Guide Prof. M. Bhandari

Co. Guide Prof. N. Sadhu

Ask any woman and she will say that doing the dishes after meals is the most unwilling job they have to do.

The first dishwasher was invented in America in 1850

Joel Houghton patented a wooden machine with a hand-turned wheel that splashed water on dishes.



Josephine Cochrane invented the first practical dishwasher around 1883.

Only the hotels and large restaurants were buying her ideas.

It was not until the 1950s, that dishwashers caught on with the general public as they became cheaper and a more usable size.

## Working of a dishwasher

- A dishwasher combines water with detergent, heats the mixture and sprays it against the dishes.
- It pumps out the dirty water and then rinses the dishes with clean water mixed with a rinse agent.
- After pumping out the rinse water, the dishes are dried by either heating or air drying them.
- The selector switch allows you to pick a variety of cycles which vary the length of wash, water temperature and drying temperature.

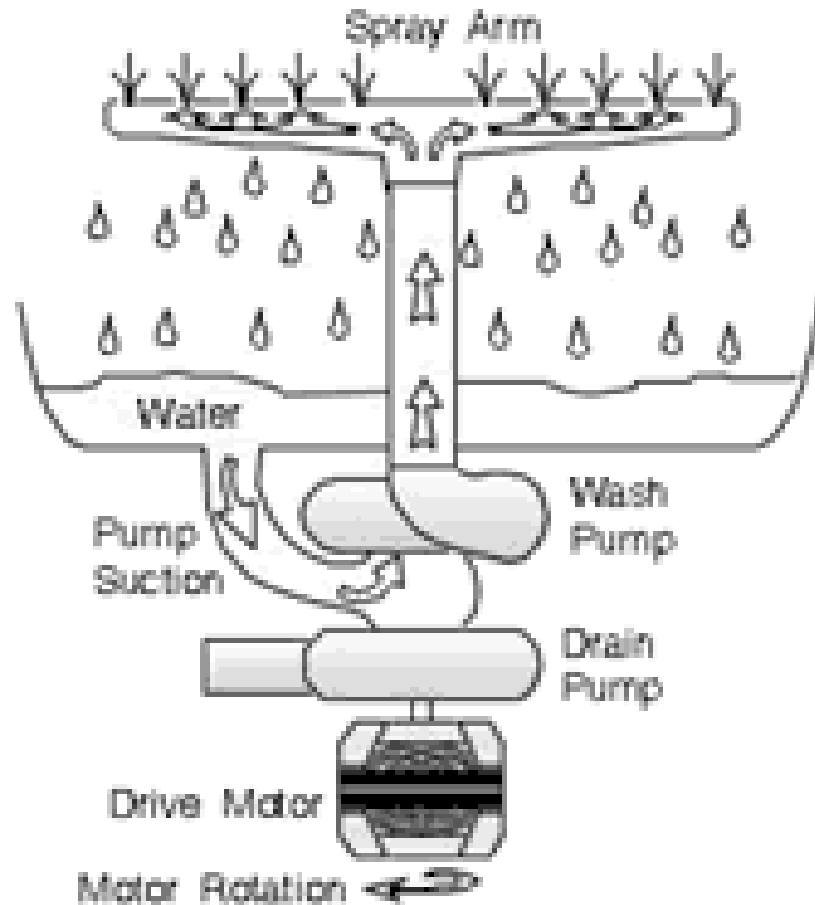

### Various parts of the dishwasher

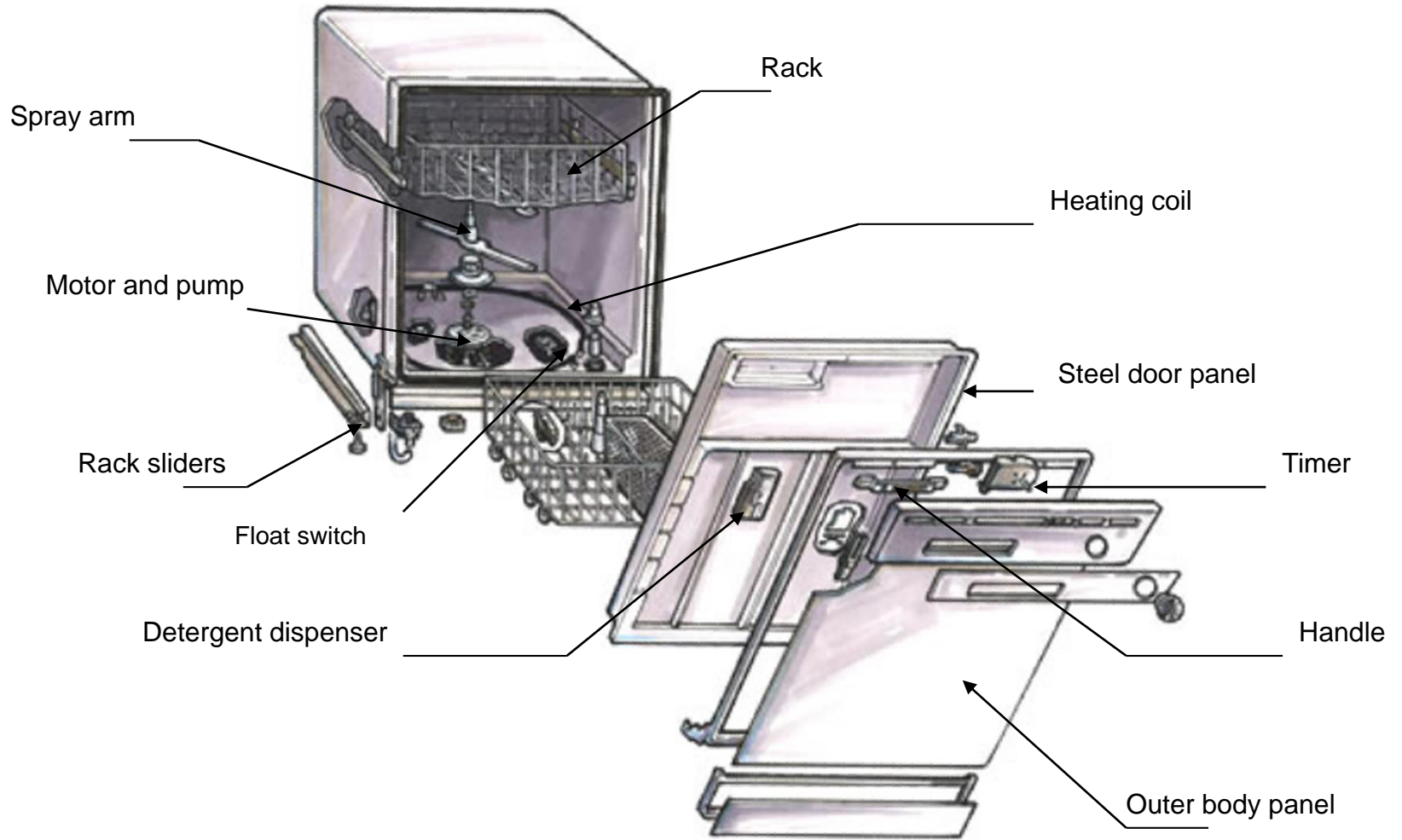



*The acceptance of alien ideas and objects into new cultures and its adoption is a steady and incremental process.*

*Prof. Athvankar*



*Adaptation of a dishwasher in our culture has been rather too slow*



# Survey

The survey was done in three parts

Product survey

Non dishwasher user- survey

Dishwasher user- survey

Product survey



IFB  
Zephyr  
26,000



IFB  
Neptune  
21,500



Siemens  
32,100

## Analysis



## Racks

Two levels of sliding racks in mild steel and PVC coated

Slots to place the dishes

Silverware basket

Smaller items on upper rack

Big vessels on lower racks

Slots for dishes on both racks

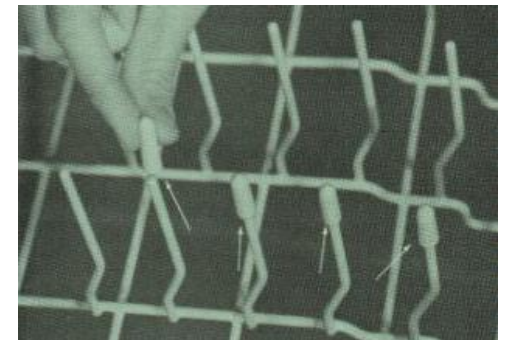

## Spray Arms

- Three levels of spray arms made of plastic
- Combination of clockwise and anticlockwise rotation
- Self propelled
- Nozzle angle adjusted for maximum coverage.





Filter to strain the waste, pulverize it and drain it along with the drain water

Detergent dispenser that holds detergent and rinse aid





The interior

Made up of stainless steel for durable and clean look

## Construction

Flat sheet metal panels as mostly dishwashers are under the counter type

Front panel is also mostly flat so that it can be laminated

Painted or having a brushed steel finish

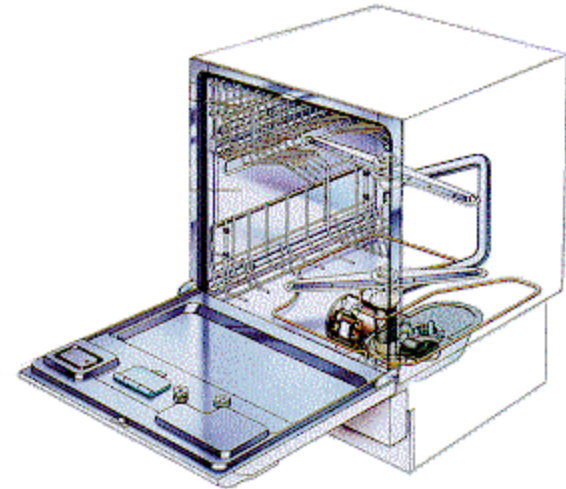

*Now you see it..*



*Now you don't..*



***Good points that were considered  
from the existing dishwasher***

*Sliding racks*

*Stainless steel interiors*

*Silverware basket*

*Pulverizing filter*

*Door sealing*



## User survey



User survey was done with both the dishwasher users, non users and the maids.

Also the kitchen layouts, the various appliances that are kept in the kitchen, the kind of utensils that are used, and their quantity were studied.

**Availability of space in the kitchen was carefully observed for it gave me key insights for designing my dishwasher.**



## Manual dishwashing Insights from maids and housewives

- Maid washes quickly and is cheap. Comes once a day.
- Maid does not wipe dry the dishes.
- Common complaint is that maid uses more detergent and traces of it remain after washing
- Nearly 100 liters of water is consumed per wash
- 4 kg of detergent or 3 vim bars are consumed every month.
  
- Maid never works at night.
- Utensils that are used at night are washed by the maid next day. Some do the night dishes themselves
- Dishes are most of the times pre rinsed and kept before the maid comes
- Tough to clean vessels of rice, milk and frying pans are soaked before cleaning.
- Hot water is never used.
  
- They think there is no space in the kitchen.
- Working couples find it inconvenient to keep a maid
- Those who do the dishes themselves at least once, want to have a dishwasher

## Activity analysis



### Activity analysis insights

- Lots of wastage of water, as it is kept running during washing.
  - Running water rinses the other dishes in the sink
  - Bai generally uses excessive detergents than the lady of the house.
  - Tendency is to scrub and wash dishes in batches of two or three.
  - She is in a hurry to complete the job at hand and move to a new house
- 
- Bai can inspect dishes and if they are not clean can scrub them again.
  - Wire scrubs are used to clean tava and kadai. They also need more application of force.
  - Sink in the kitchen is always loaded with dishes.
  - Milk vessels are scrapped with a spoon.
  - Inside of glasses is difficult to scrub.
- 
- Two large vessels are always there per washing.
  - The smaller items like spoons and katoris and small plates are more tedious to wash than the larger items. This is an indication that priority must be given to smaller items than a few big ones in the dishwasher.
- 
- Body language of the lady of the house reveals that she hates doing that chore.
  - Feels tired and exhausted after the job is done
  - It can take nearly an hour to finish all the dishes depending upon how many batches are washed together.

## Dishwasher user survey



## Insights from dishwasher users

### On cleaning

- It cleans better than a maid. Good thing is that it steams everything and therefore kills germs.
- Even milk vessels and rice pots are cleaned.
- Don't lose a single piece of crockery or even fragile glasses - so that's a big saving. Crockery comes out sparkling clean.
- They feel hygiene is a big factor. No maid can get close to this convenience.
- If maids do the dishes then some users steam them after that in the dishwasher

### On Usability

- You have to rinse the dishes but then you often do that even for the maid lest numerous flies and bugs party around your kitchen.
- The current dishwasher is not suited for Indian vessels, eg. Plates with edges.
- Arranging the dishes is sometimes critical, and requires patience and practice.
- With a dishwasher, you also have the headache of loading and unloading it - with a maid, you don't.
- Availability of detergent is not too smooth.
- One has more privacy around the house and lives to their own schedules.

### On space and location

- If smartly placed under the kitchen countertop next to the sink - u load it immediately and your kitchen never looks dirty
- But the platform has to be broken to install the dishwasher under it. There is no standardization of platform height



## Dishwashing needs

**Variety/quantity of dishes per wash**  
(average family of four)



# Product brief

## User:

Middle class, lower middle class, earning an average of 15,000 Rs. Per month.

This class of user is the one whose buying power has increased considerably in the recent past and aspires to have the conveniences of the richer class. He is though particular and very critical of the products he buys. Has inconvenience to keep a maid to do the dishes because of inconvenient working hours. Lives in an apartment with a small kitchen.

## Capacity: (for a family of four)

Minimum 5 large plates  
6 small plates  
6 glasses  
6 katoris  
6 small bowls  
cutlery  
3 medium pots  
pan

Vessels like cooker which are not washed daily are too big to accommodate in the dishwasher, and for its sake its size becomes big. For a 25% increase in space for just one vessel the cost of the dishwasher also goes up by 15 %. Hence, the suggestion to exclude them from washing in the dishwasher.

# Product brief

## Usability:

- Placed next to or above the sink
- Should have ease in loading and unloading.
- Should have minimum manual involvement
- Dishwasher itself should be easy to clean; all parts should be easily accessible.
- Can act as a temporary storage so that sink area is clean.
- Controls should be ergonomically situated
- Even an illiterate maid, if need be should be able to use it.
- Should be easy to connect to the water inlet and drainage. (plug and play)
- In case of repairs should be easy to remove and install back.

## Health and Hygiene:

- Should communicate and should clean better than hand and **disinfect**.  
This is important for the **dishes that are not heated** and are not used **for cooking** as bacterial growth is more likely to occur in these utensils. Also manual involvement for occurrence of contamination should be reduced.
- Should use less detergent and rinse the dishes properly.  
No traces of powder should remain. Even though the chemicals available today are safe on hands, it is not guaranteed that they are harmless if consumed.

## Form:

- Production cheap, but costly looking
- Stainless steel interiors for durability.
- Should communicate the way to use it on its own.
- Should be easy to maintain.
- Should have a costly hi-tech kitchen appliance look.

# Concept generation

## Hunt for space

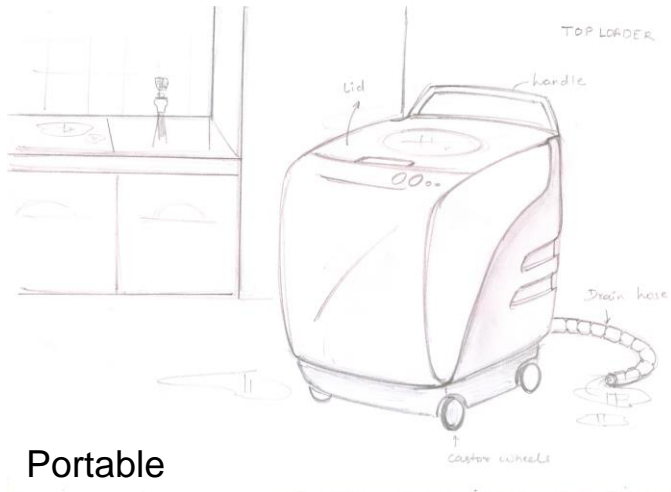

Portable



Integrated with the sink

# Concepts for vessel configuration/arrangement for dishwasher

## Category I – Over the Counter

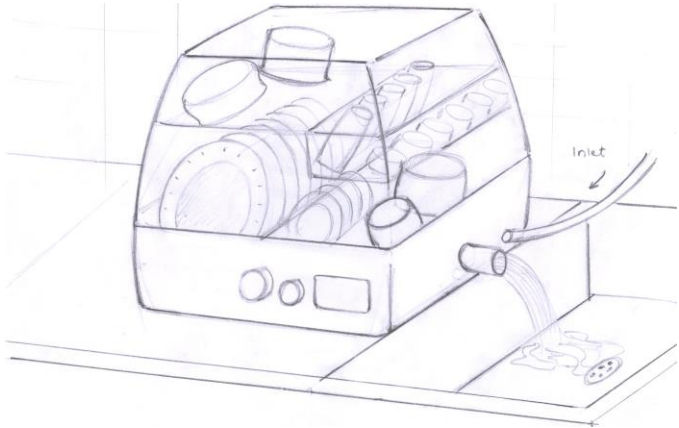
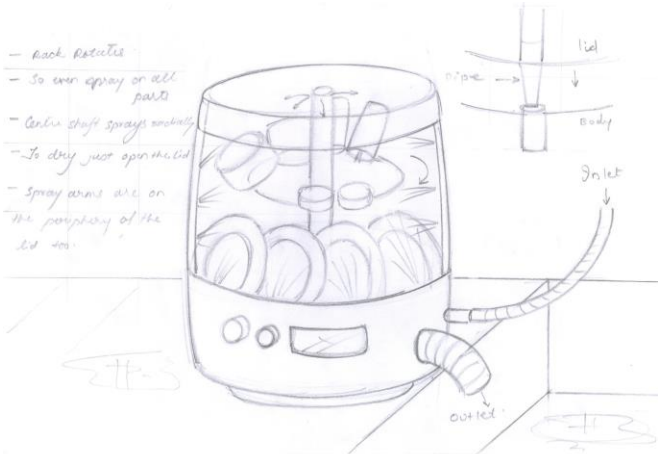

**Category I - concept I**

500 x 400 x 650 (W x D x H)

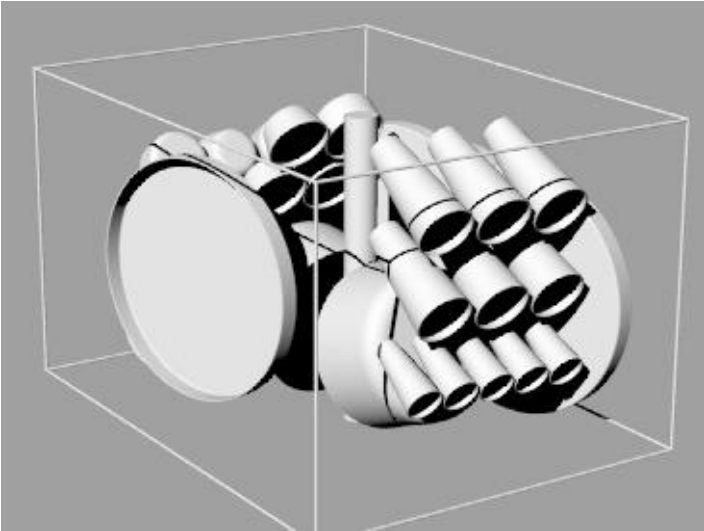
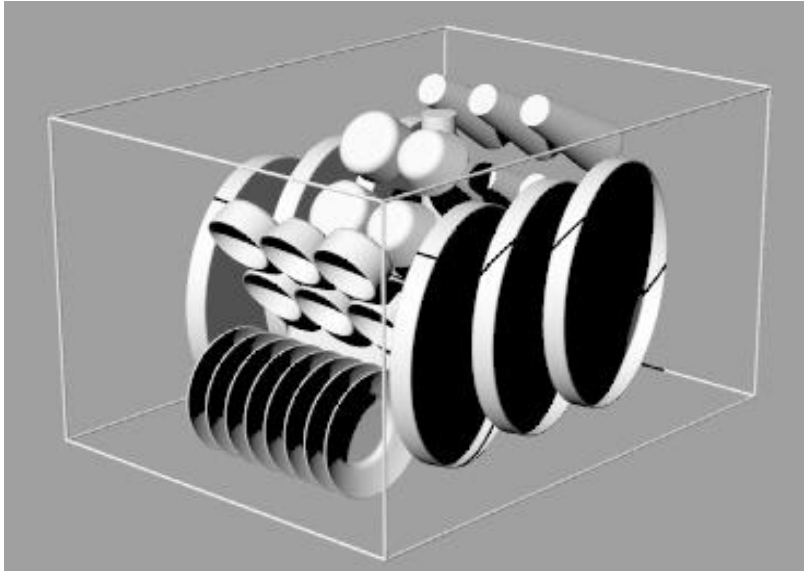

## Category I - concept 2

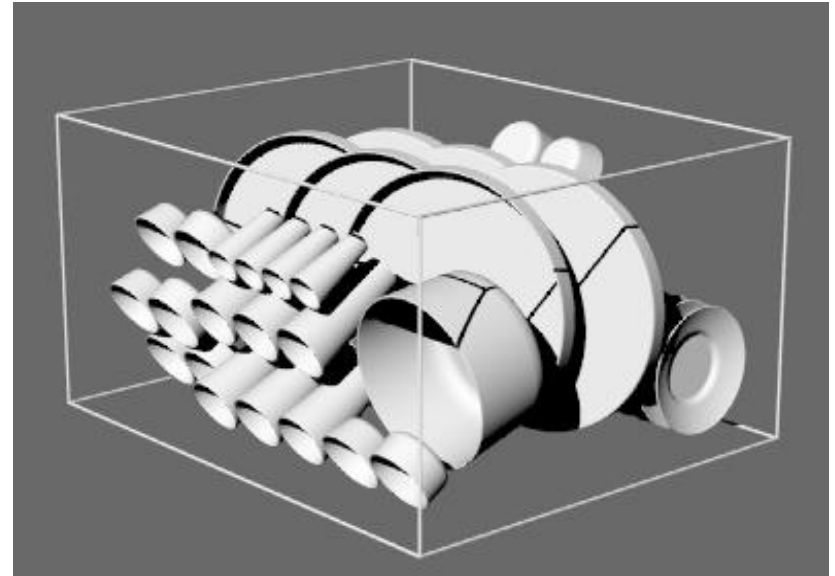
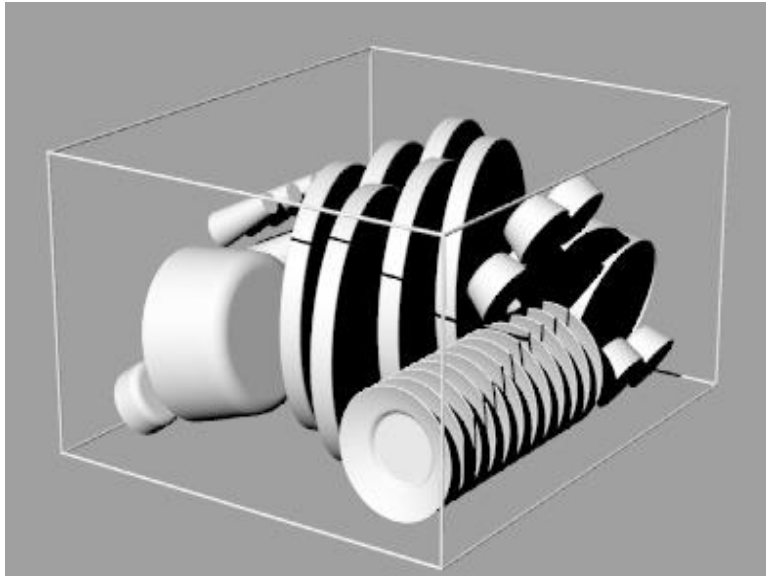

550 x 350 x 650 (W x D x H )

### ***Advantages***

No need to break anything to install  
Could be placed near the water and drain source  
Since it was at a suitable height, arranging the dishes was easier.

### ***Disadvantages***

Takes up platform space all the time, unless if made light enough to be placed elsewhere after use.  
Complex arrangement of spray arms  
Sealing would have been difficult.

## Category II – Flat against the wall (vessel arrangement)

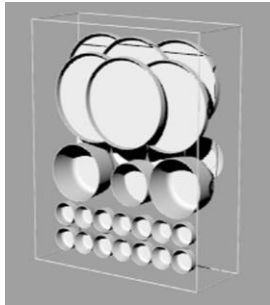

660 x 830 x 250 (W x D x H )

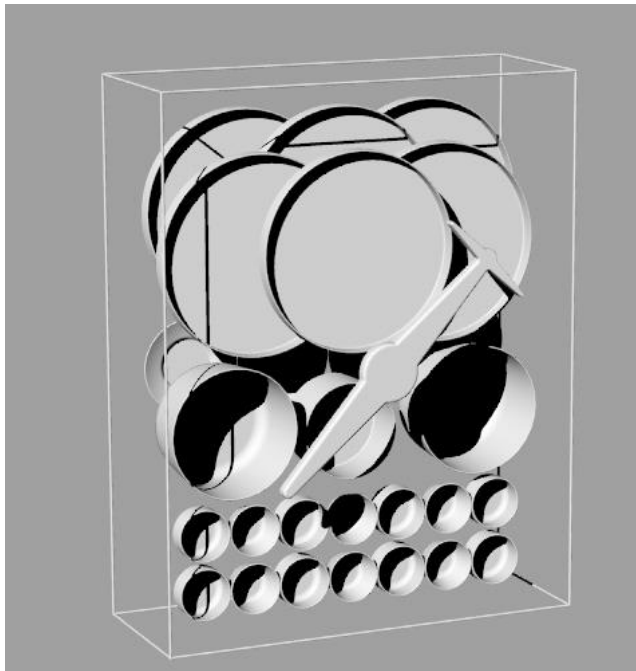

### Concept I

#### **Advantages**

The door closing and sealing detailing would have been the same as the existing dishwashers which was tested and proven

Takes no effective space on the floor

Loading the dishes is easier, can be compared to loading dishes on the steel racks.

#### **Disadvantages**

Since it was flat, size in terms of its length and breadth is very large.

The rear plates were less exposed than the front ones.

The top level could be out of reach of the 5th %tile woman.

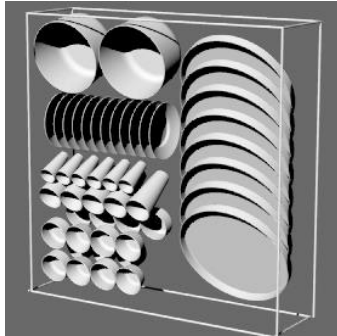

750 x 750 x 200 (W x D x H )

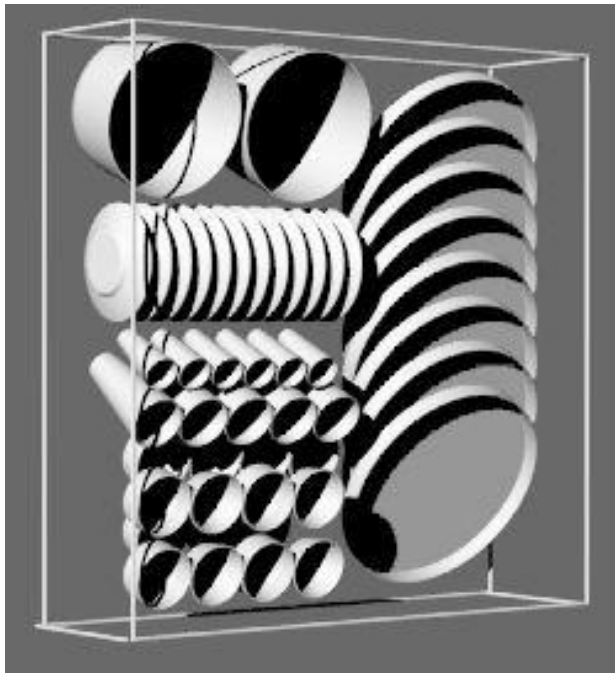

## Category II - concept 2

### ***Advantages***

are that owing to the downward facing of plates water will drain easily.

Ease in loading the katoris.

Spray reachability in all corners is adequate.

### ***Disadvantages***

Since the pots are at higher level, then if there smaller pots in larger no. arranging them will be difficult at that level.

The orientation of the plates is not easy to construct a rack around either.

No of vessels that can be washed are less.

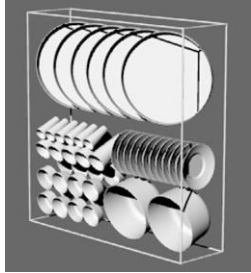

750 x 700 x 200 (W x D x H )

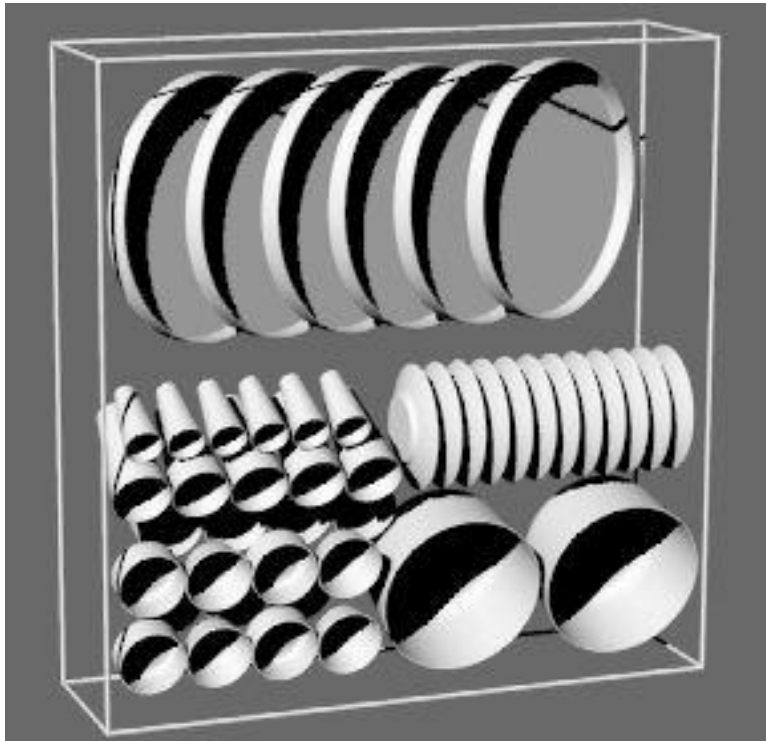

### Category II - concept 3

#### ***Advantages***

Loading the plates is easier

Washes the same no of items as the previous layout but the height and hence the size is greatly reduced.

Spray reach ability in all corners is adequate.

#### ***Disadvantages***

In this arrangement too, the no of pots that can be washed are less.

750 x 750 x 200 (W x D x H)

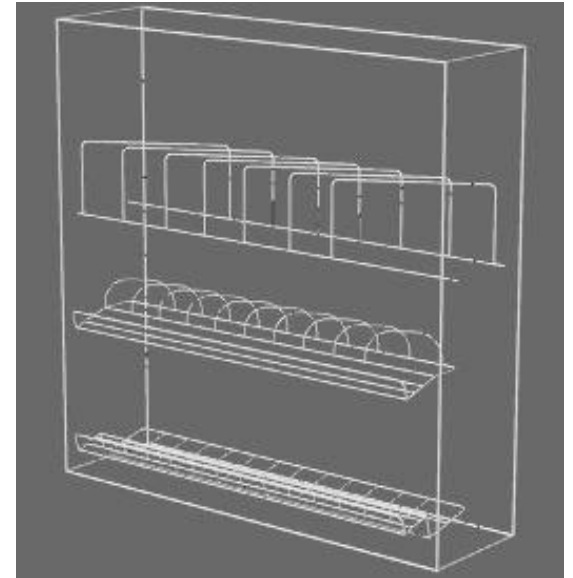
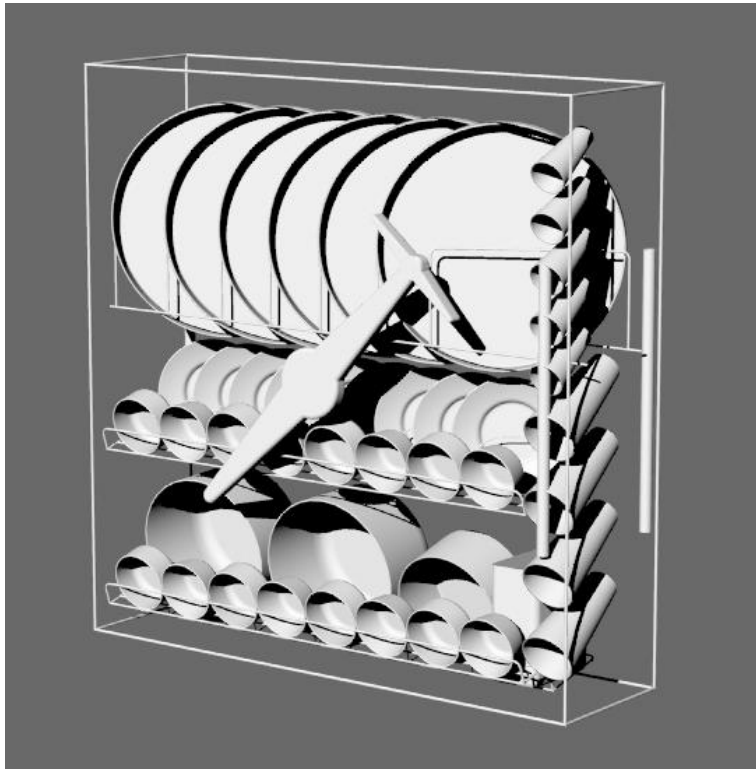

## Category II - concept 4

### ***Advantages***

- Efficient use of interior space.
- All vessels exposed sufficiently for better cleaning
- The most compact size
- Ease of loading the dishes.

### ***Disadvantages***

- Interchangeability is not there.
- Glasses are loosely arranged.
- Vessels of a kind are not grouped well together.

750 x 700 x 200 (W x D x H)

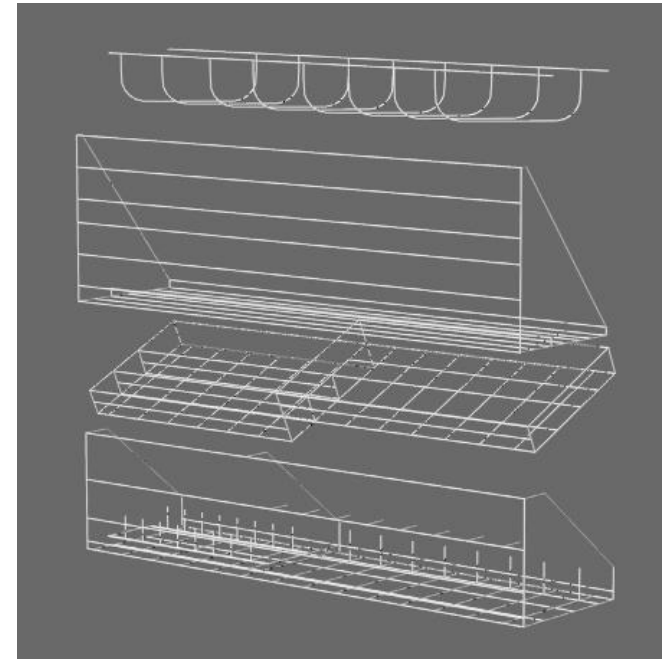
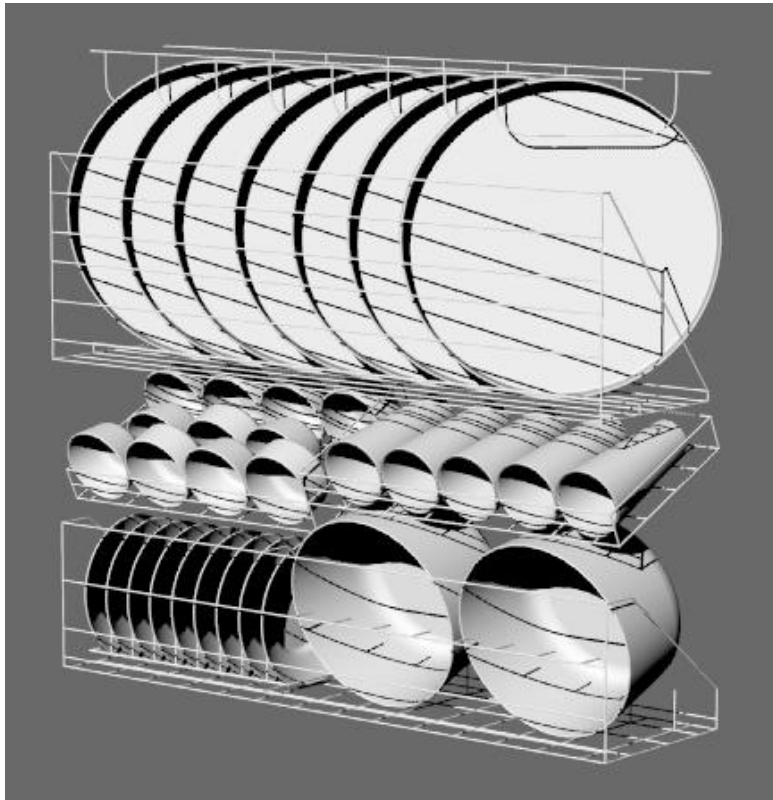

## Category II - concept 5

### ***Advantages***

All vessels exposed sufficiently for better cleaning  
Ease of loading the dishes.

### ***Disadvantages***

Interchangeability is not there.  
No of pots are less

## Evaluation of vessel arrangement / configuration

### Evaluation chart

	Category I C 1	Category I C2	Category II C1	Category II C2	Category II C3	Category II C4	Category II C5
size (10)	2.5	2.5	1	1	3	3	3.5
Spray arm reach (8)	2	2.5	3.5	3	3.5	3.5	4
Ease of loading and unloading (8)	1	1	2	2	3.5	3.5	3.5
variety and no. of vessels washed (7)	3	3	2	3	3	3.5	3
Grouping of vessels(4)	4	4	4	4	4	2	4
Total	86	90	91	87	123	118.5	132
Rating	1.954	2.045	2.068	1.977	2.975	2.681	3.000

The category II concept 5 scored the maximum and hence was selected for further refinement

# Refinement of selected vessel arrangement

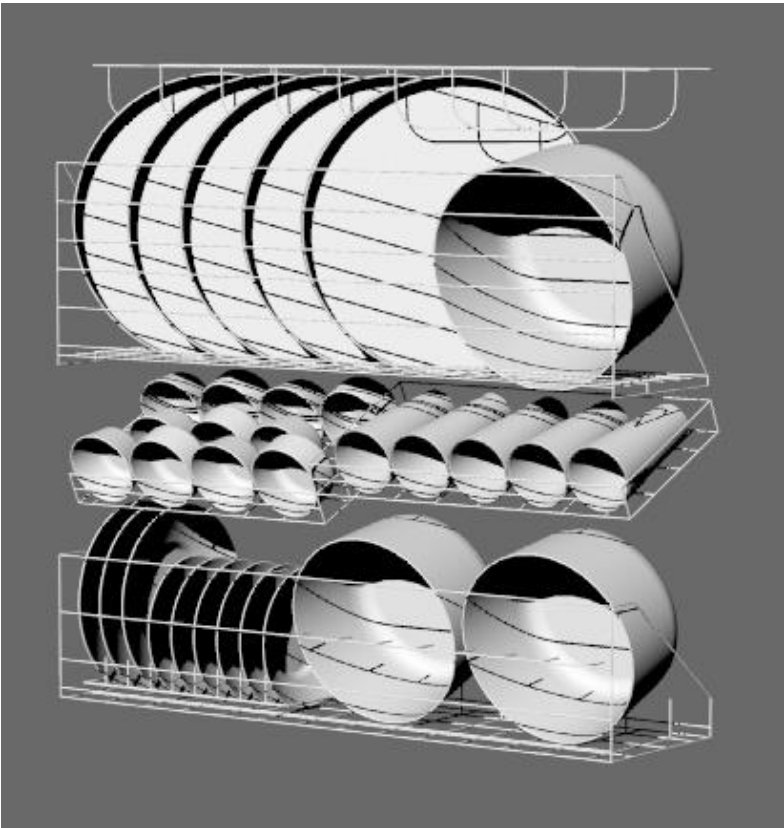

Iteration 1

# Refinement of selected vessel arrangement

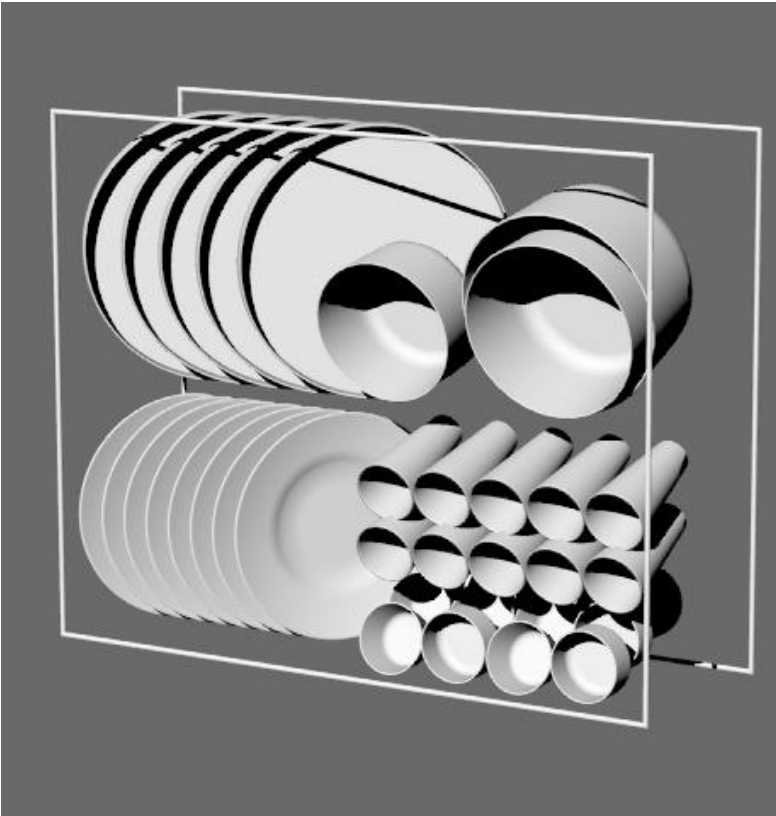

**Iteration 2**

# Refinement of selected vessel arrangement

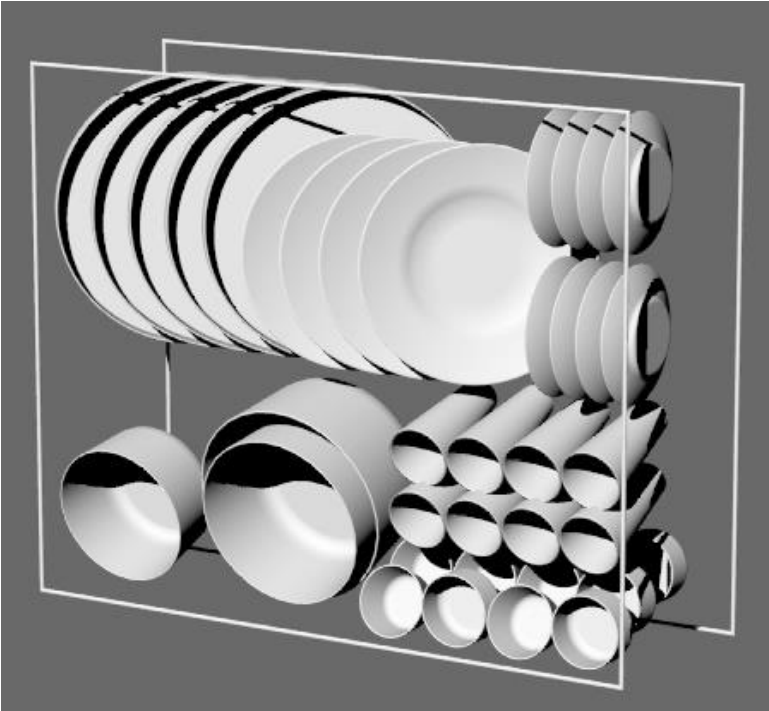

**Iteration 3**

Refinement of selected vessel arrangement

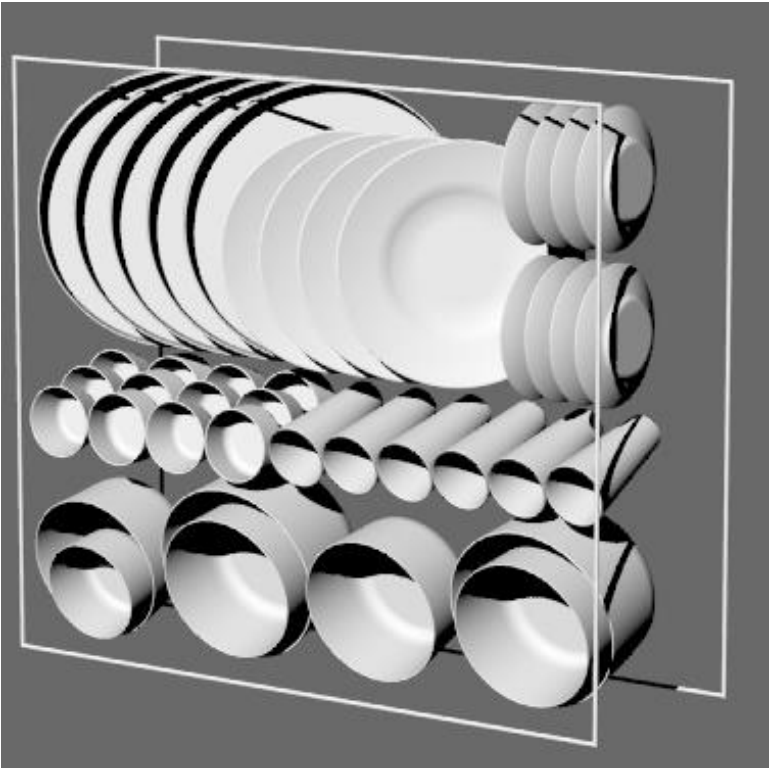

Iteration 4

## Refinement of selected vessel arrangement

750 x 600 x 200 (W x D x H )

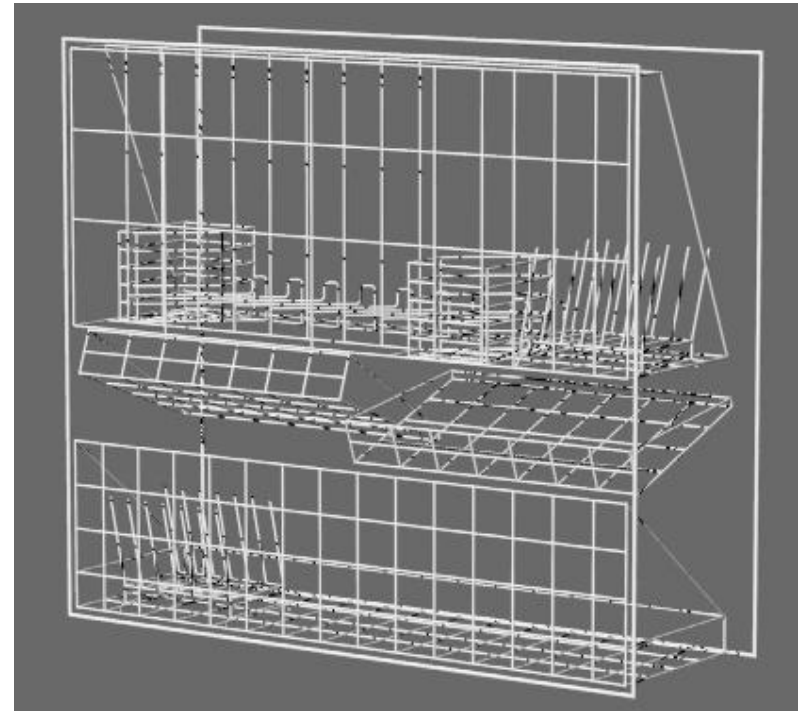
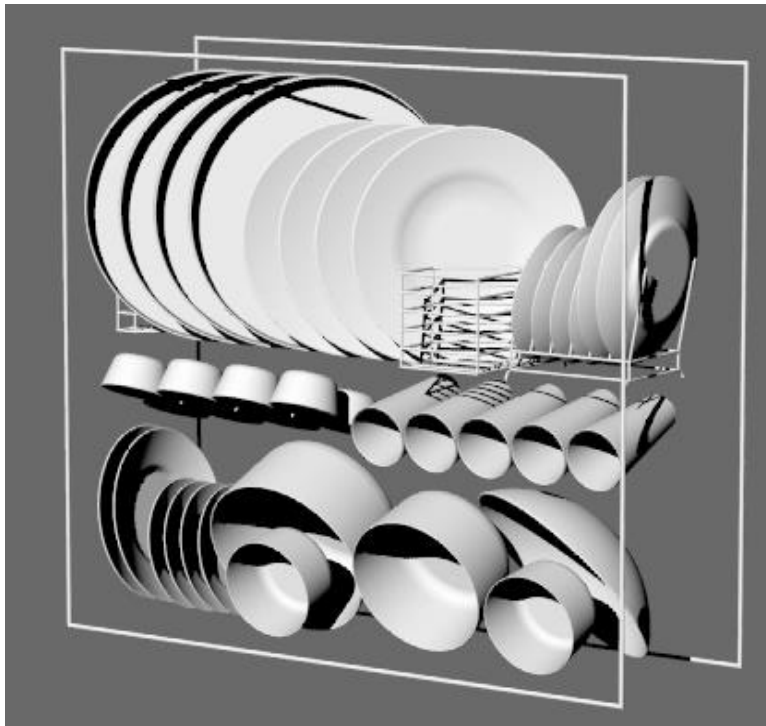

**Iteration 5 : The final one**

# Exploded view of proposed design concept

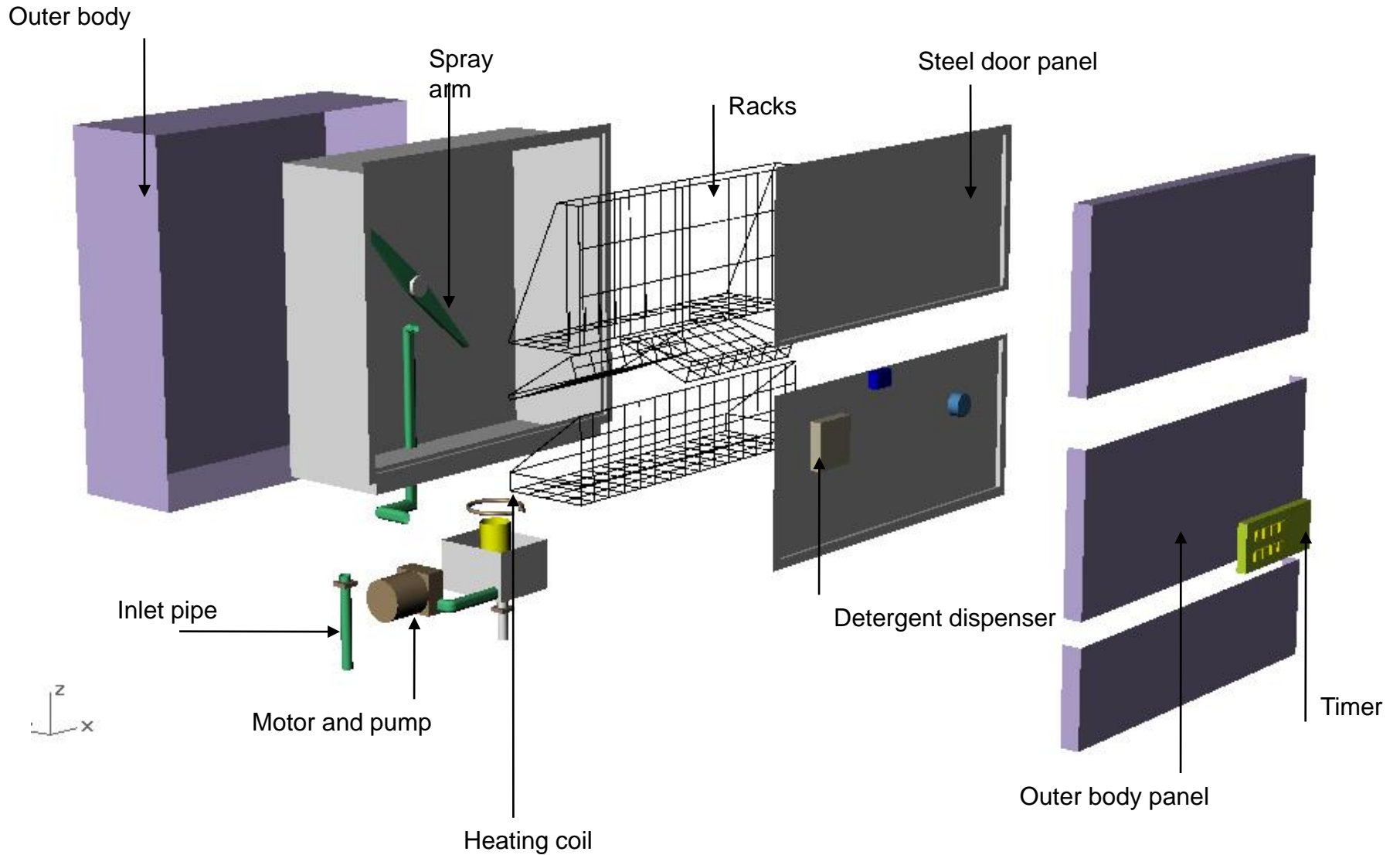

# Testing of the full scale rack



Loading side

Spray arm side



# Product semantics



Product should not lose its links with the primary object category. Care I thought would have to be taken to keep the product well within the semantic space of the dishwasher category.



For that I subdivided the product in three different levels

Primary category - Expression of a kitchen appliance

Secondary category - Compactness  
Dishwasherness

Partner concepts - Expression of status

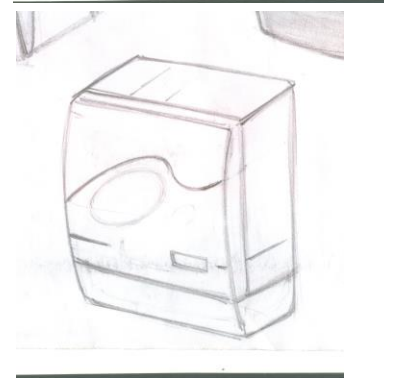
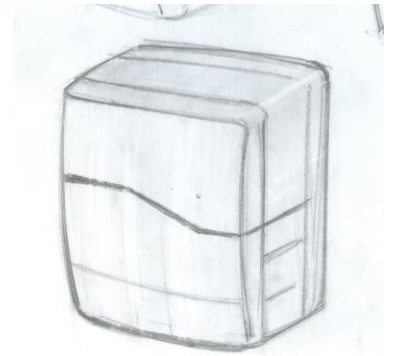
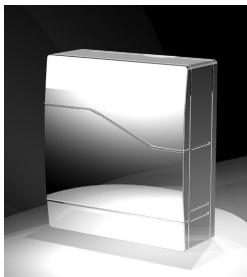
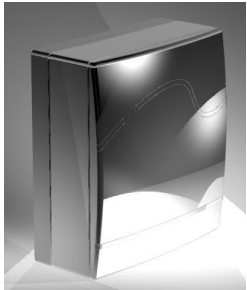

## Form generation

### Category I : Single door opening on one side.

The expensiveness had to come, the dishwasherness had to be defined and then there had to be that look of a kitchen appliance. The inspiration was sought from the stainless steel appliances like big ovens and the new brushed stainless steel finished refrigerators that are coming in the market.

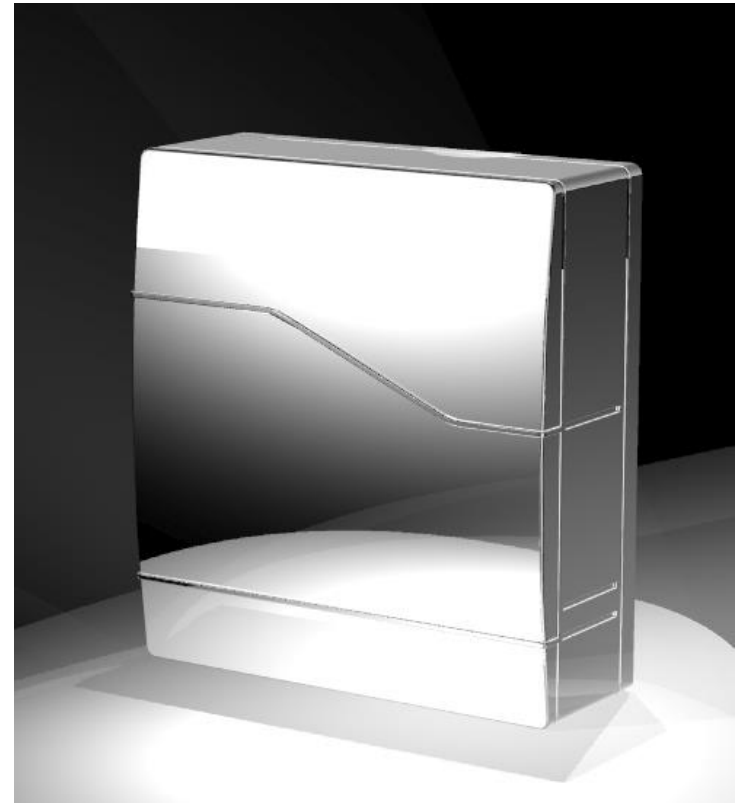
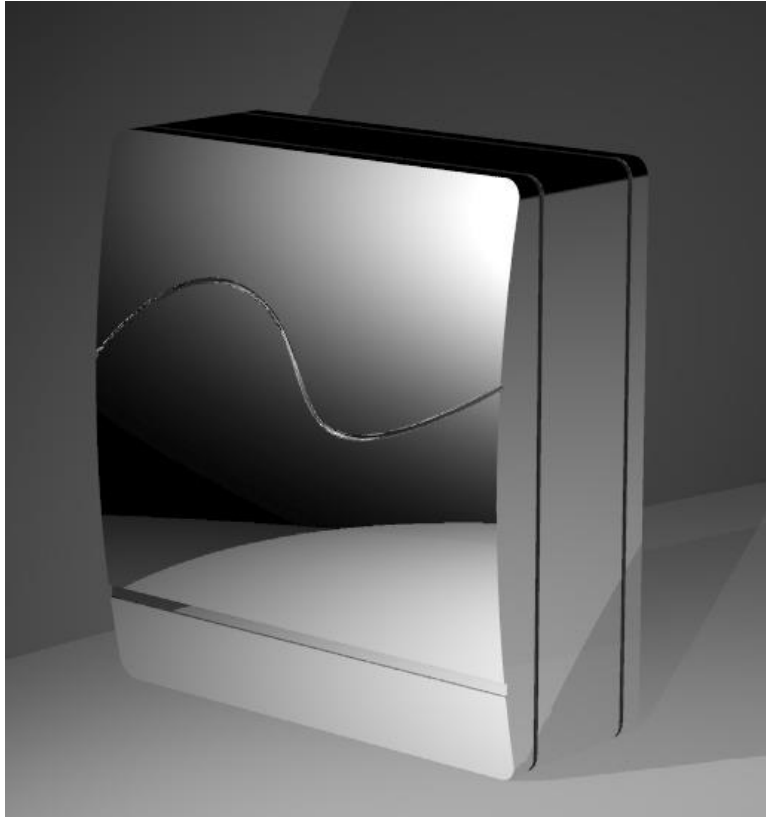

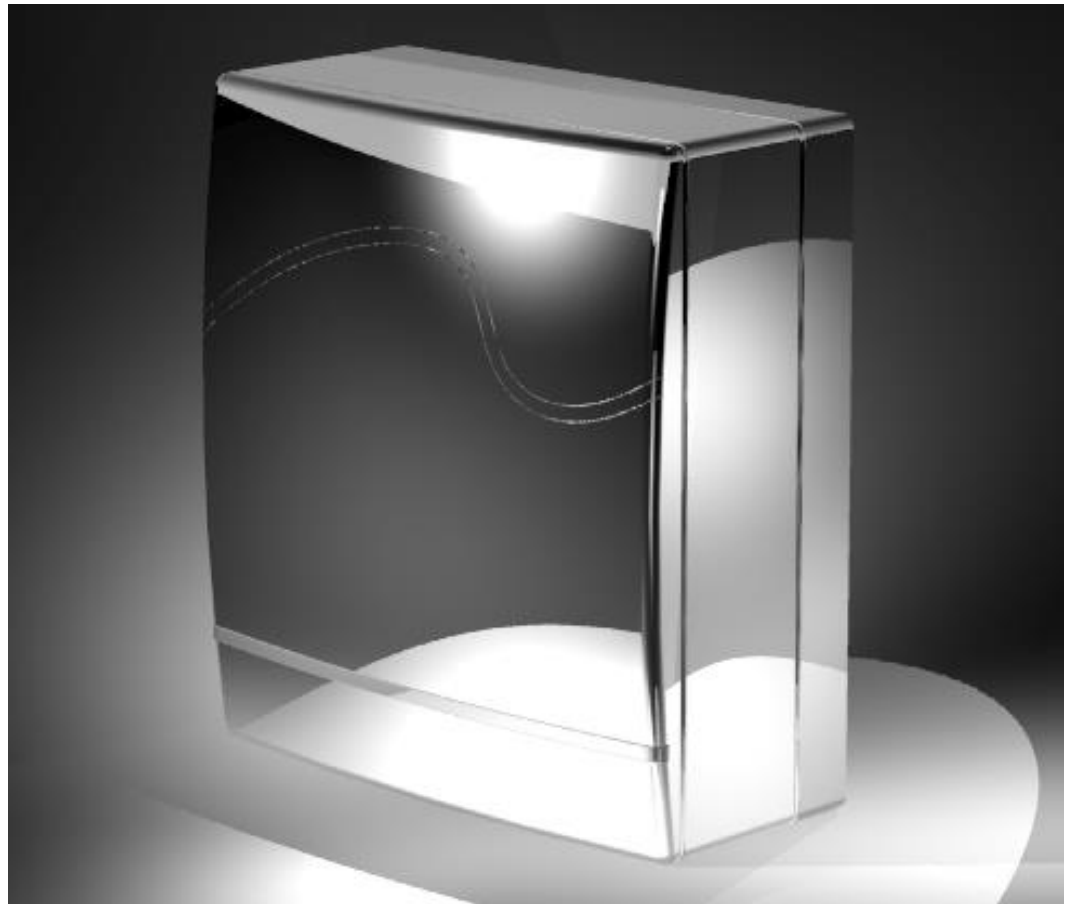
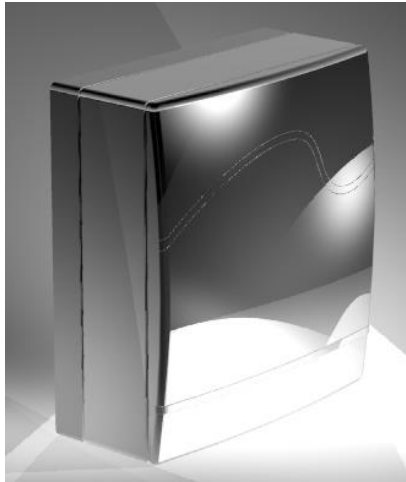



## Concept 1



After the explorations, and accessing the merits and demerits of each form, this concept was selected for its clean clear surfaces, and sharp classy yet sophisticated look.

The changes that were made to the exploration were that a rather sharp control panel was added and the top groove was toned down a bit.



## Control panel

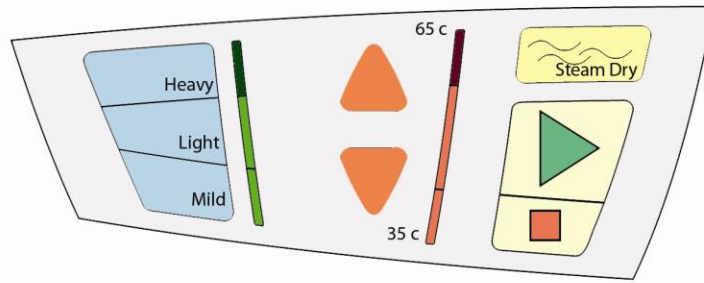

### Features of concept 1

- Single door that provides more effective sealing
- Clean front that adds minimalist uncluttered look
- Stainless steel panels, more durable and lifelong
- More appliance look. Semantically fits well as a dishwasher
- Dishwasher dispenser can be easily located on the inside of the door at a suitable height making loading of the detergent easier
- There is no window though, so cant see what is happening inside.
- The side on which the door opens will determine the corner in which it can be fitted, thereby losing out on flexibility of placing it.



## Form generation

**Category 2 : Single door opening on one side with window.**

This was a shift from what I was doing till now. I thought that giving a window in the front will help me reduce the bulk dishwasher. Again, something dynamic was happening inside, and so why to hide it. The third reason was that, since this is a new concept to the Indian homes, it would be a selling feature if one is able to give the **visual assurance of cleaning.**

# Explorations

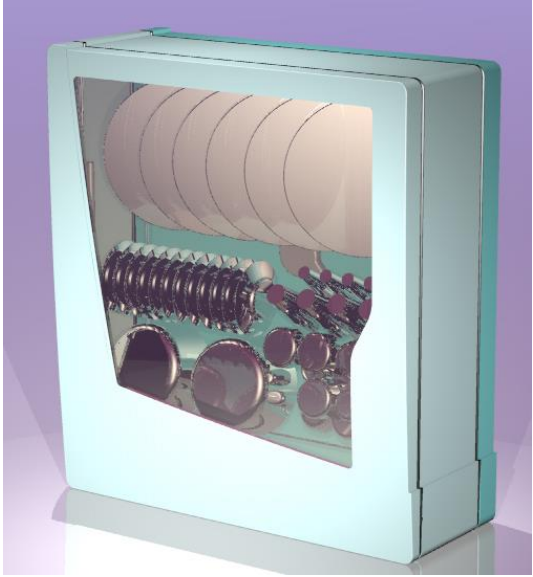

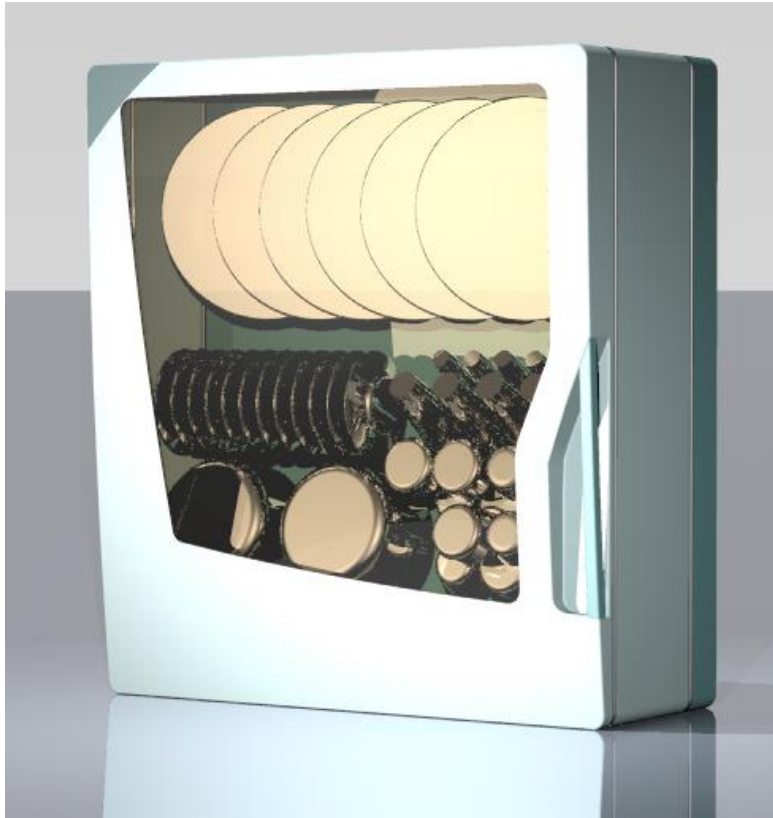

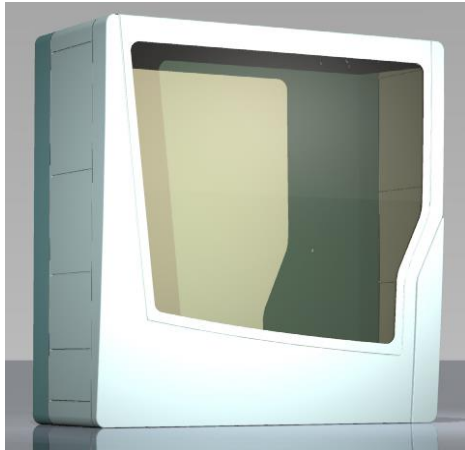

## Concept 2

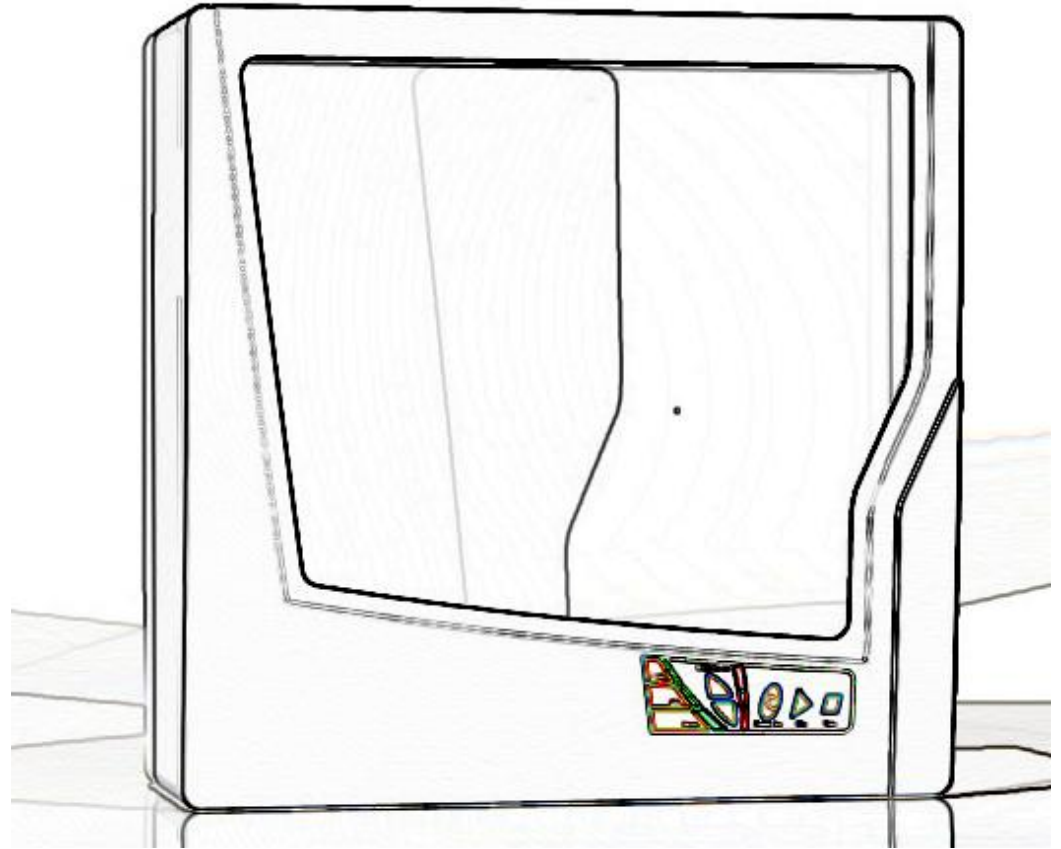

The concept of the slightly inconspicuous handle was chosen as the selected concept for this category. A control panel matching with the lines of the window was added to complete the look.



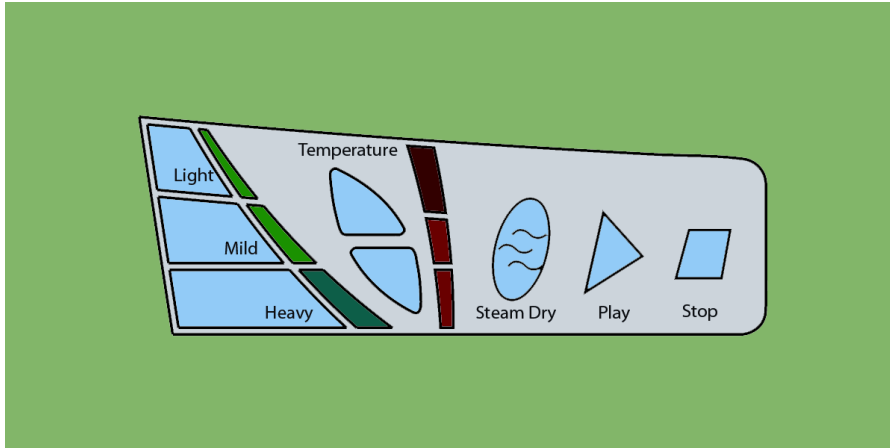

## Features of concept 2

- Single door that provides more effective sealing
- Transparent window that shows the inside and gives visual feedback.
- Appliance look is a bit sacrificed. So is the dishwasher look of an expensive gadget.
- Dishwasher dispenser cant be located on the door and has to be moved to the interior side wall. Not very difficult to access though.
- The side on which the door opens will determine the corner in which it can be fitted, thereby losing out on flexibility of placing it.

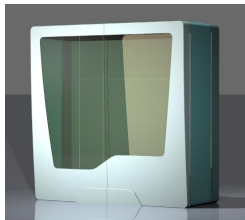
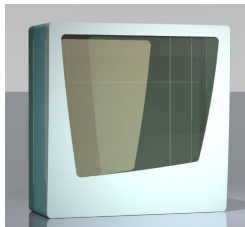

## **Form generation**

### **Category 3: Single door with window to open from both sides**

In this layout I thought of providing hinges on the outside on both sides by which after changing a couple of screws the door can be hinged on either side. The handle was brought in the centre, and the window was made symmetric.

# Explorations

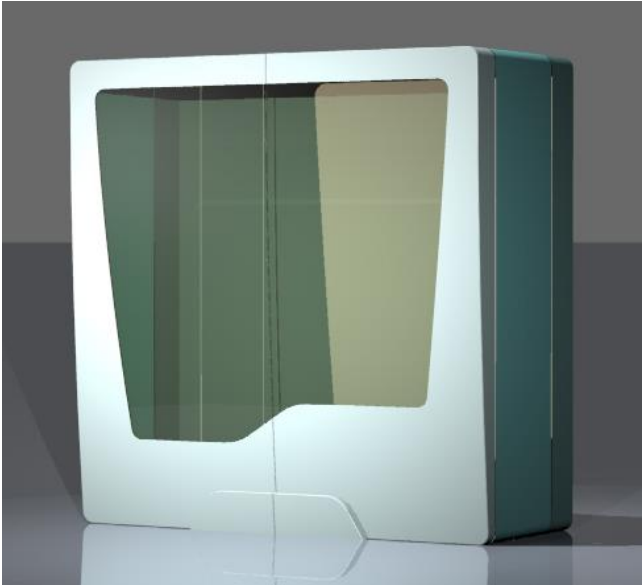
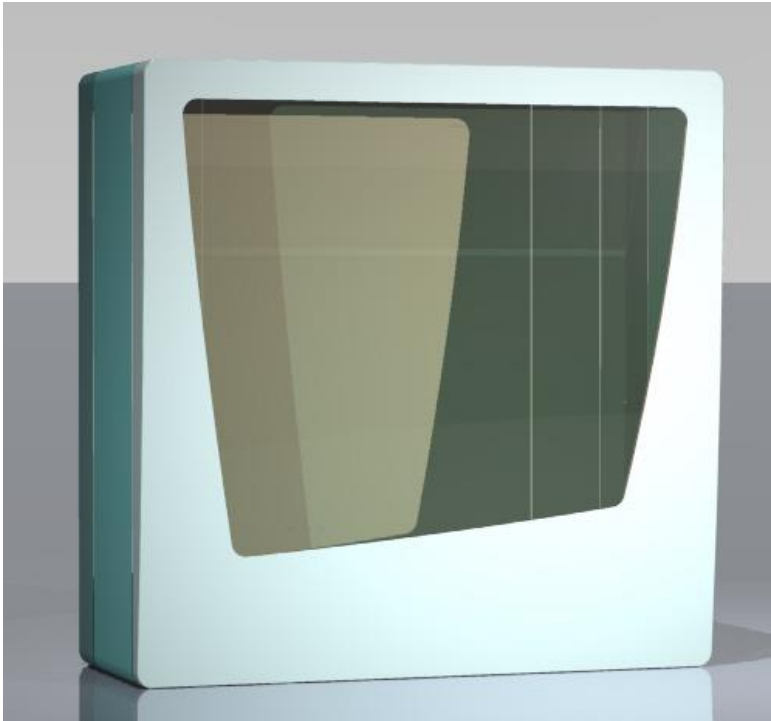

## Concept 3

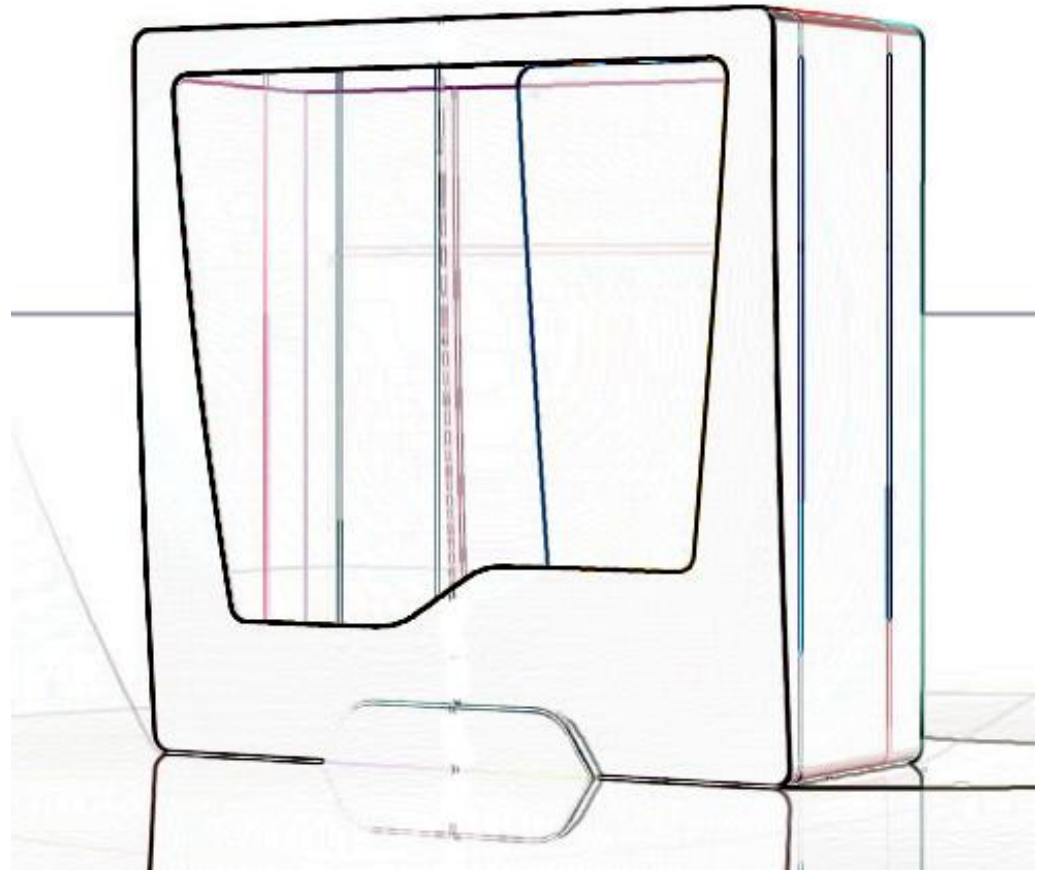

The concept of a door handle much like that of the concept 2, but on the lower edge and symmetrical in the centre to adapt to the situation of the door opening on the either side was selected

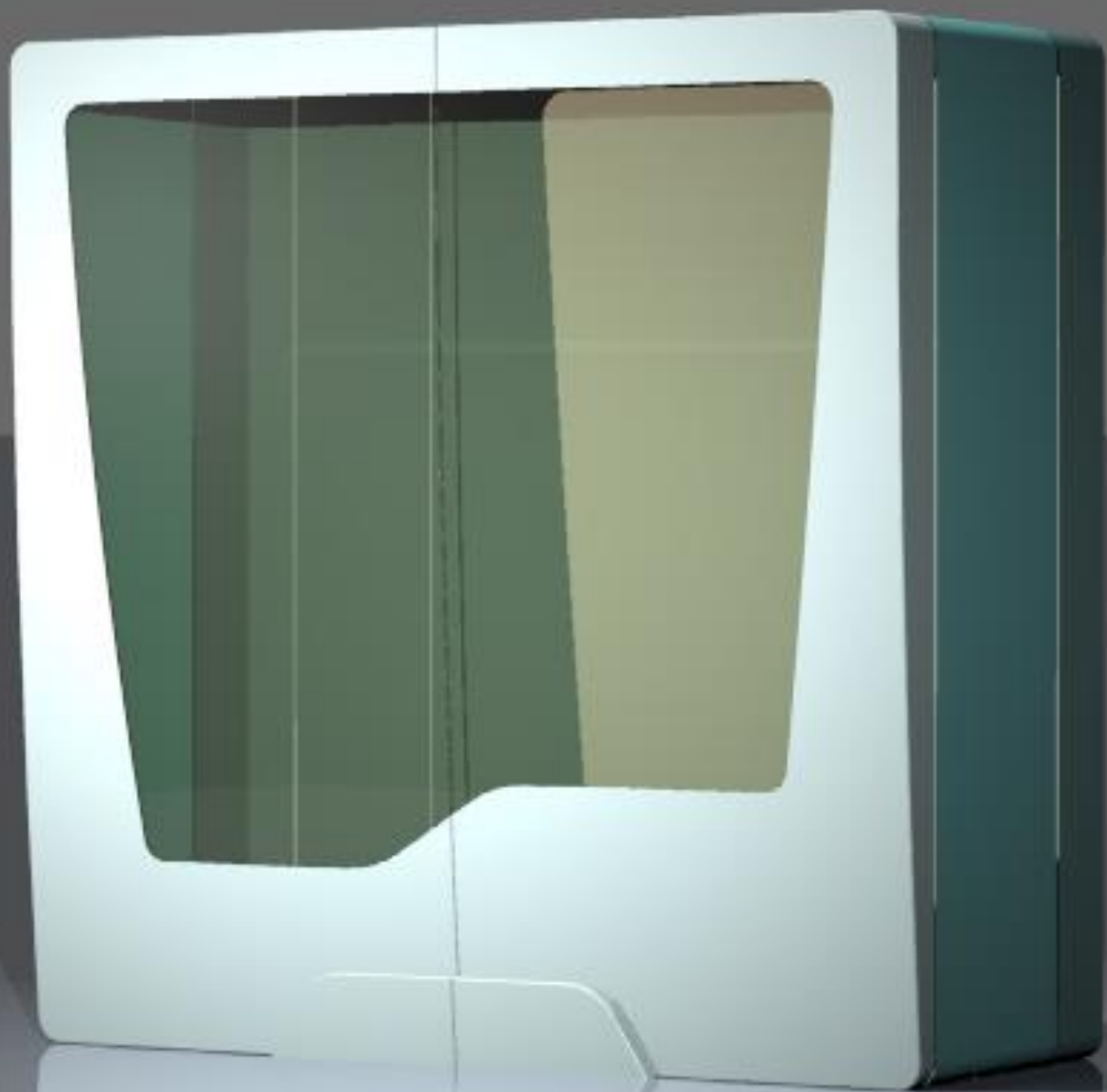

### **Features of concept 3**

- Single door that provides more effective sealing
- Ability to make the door open from both sides increases its flexibility to install it in any corner.
- Transparent window that shows the inside and gives visual feedback.
- The symmetry in the window brings the appliance look, a sense of predictability back.
- Dishwasher powder dispenser cant be located on the door and has to be moved to the interior side wall.

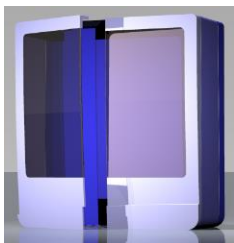
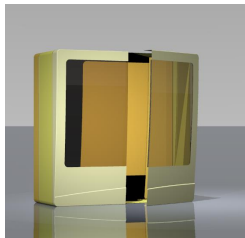
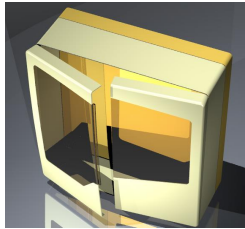

## Form generation Category 4: Split door, Vertical

As the interior layout was getting modified simultaneously, the width of the dishwasher was slightly increasing and hence the door was becoming too wide to be opened as a single door. The user would have had to take a couple of steps behind every time. I thought of splitting the door vertically in the centre, such that it opens in two halves. This immediately takes care of the previous problem of changing the opening side of the door as it could be now put in any corner, and plus wont open too much in the users area of standing.

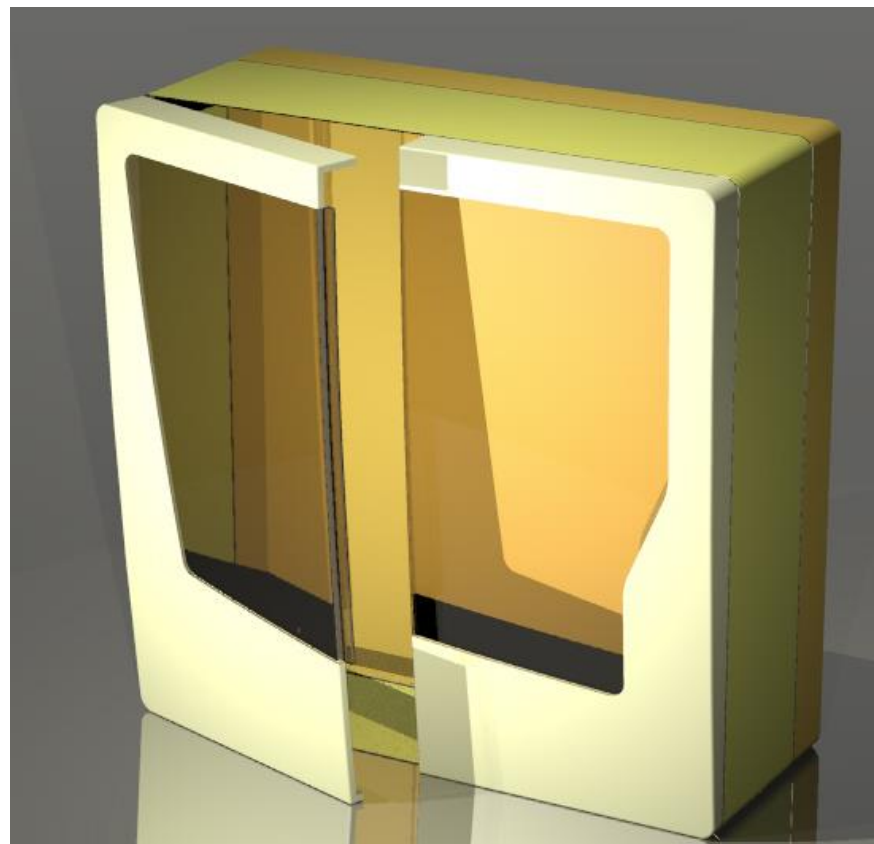
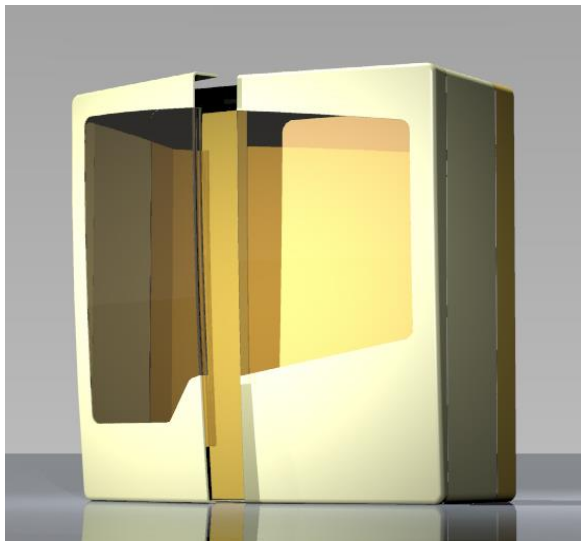
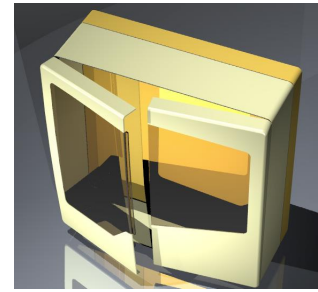
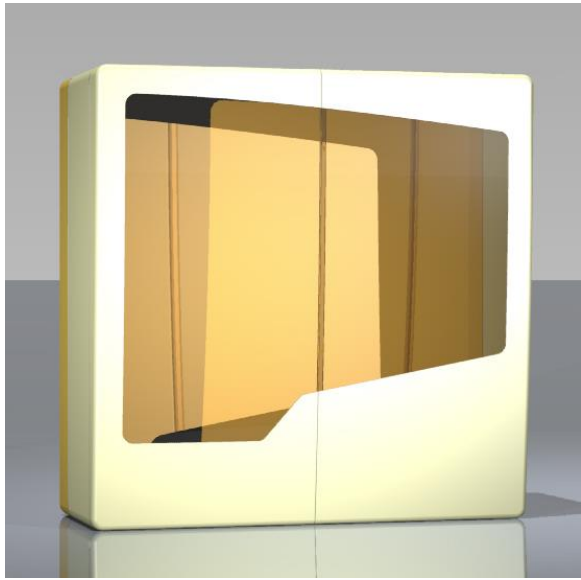

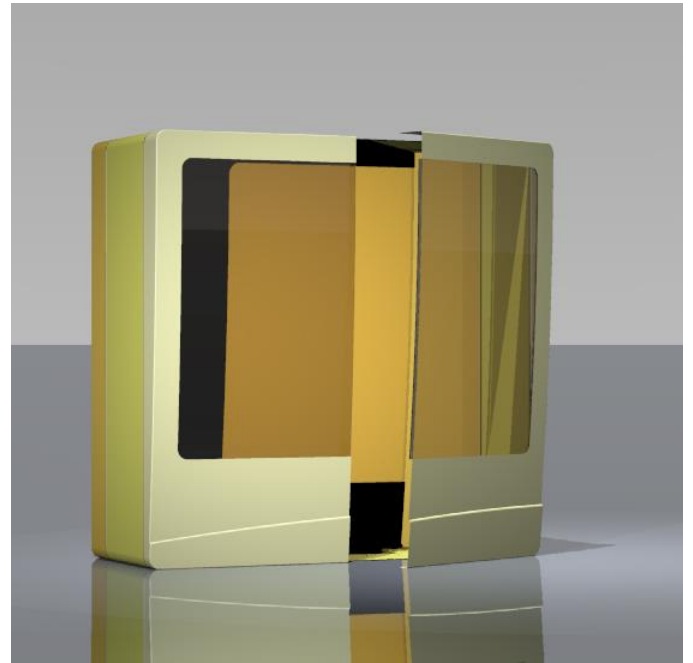
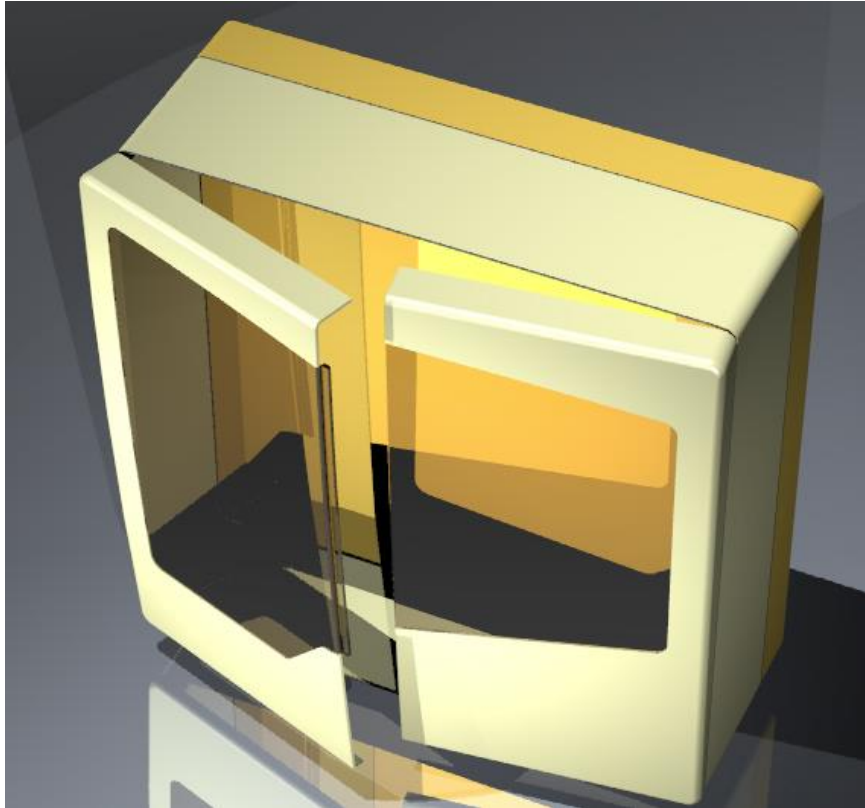

## Concept 4

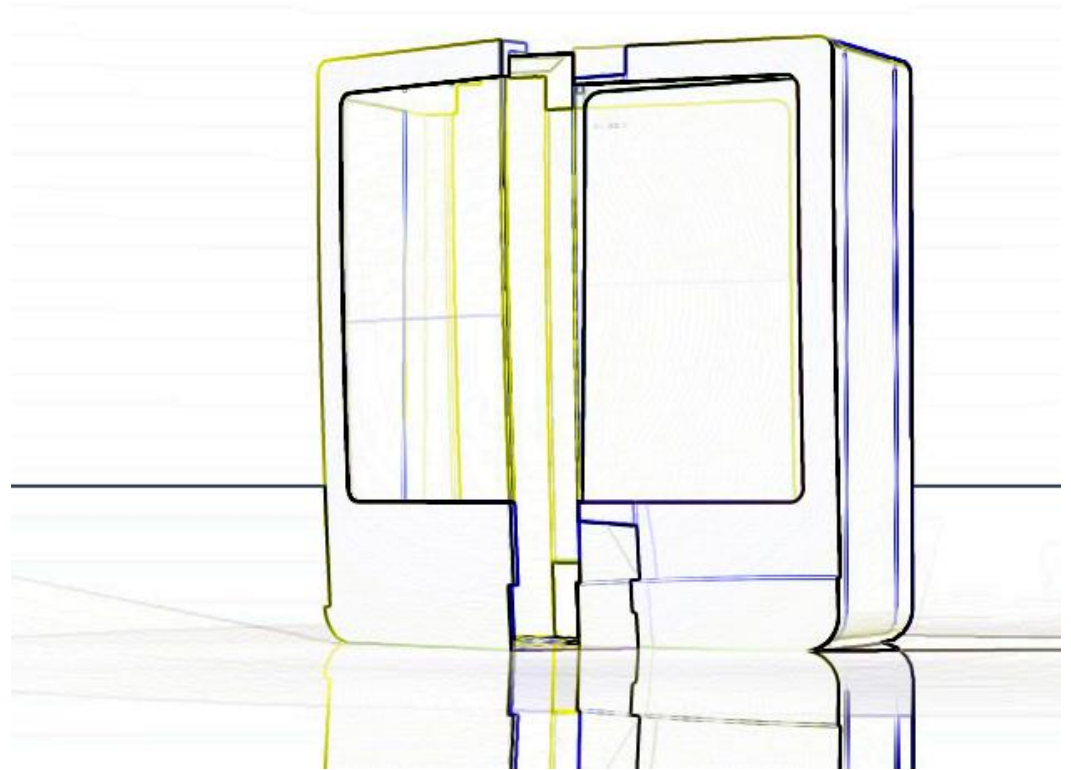

The chosen concept is the last exploration in which the radii of the lower edges were made twice the radii at the top. The inspiration was taken from the radii manipulation exercises as I wanted to make the form look lighter at the bottom so that when it is put up on the wall, it does not look bulky.

The simplicity of the window was maintained to have that moderate look

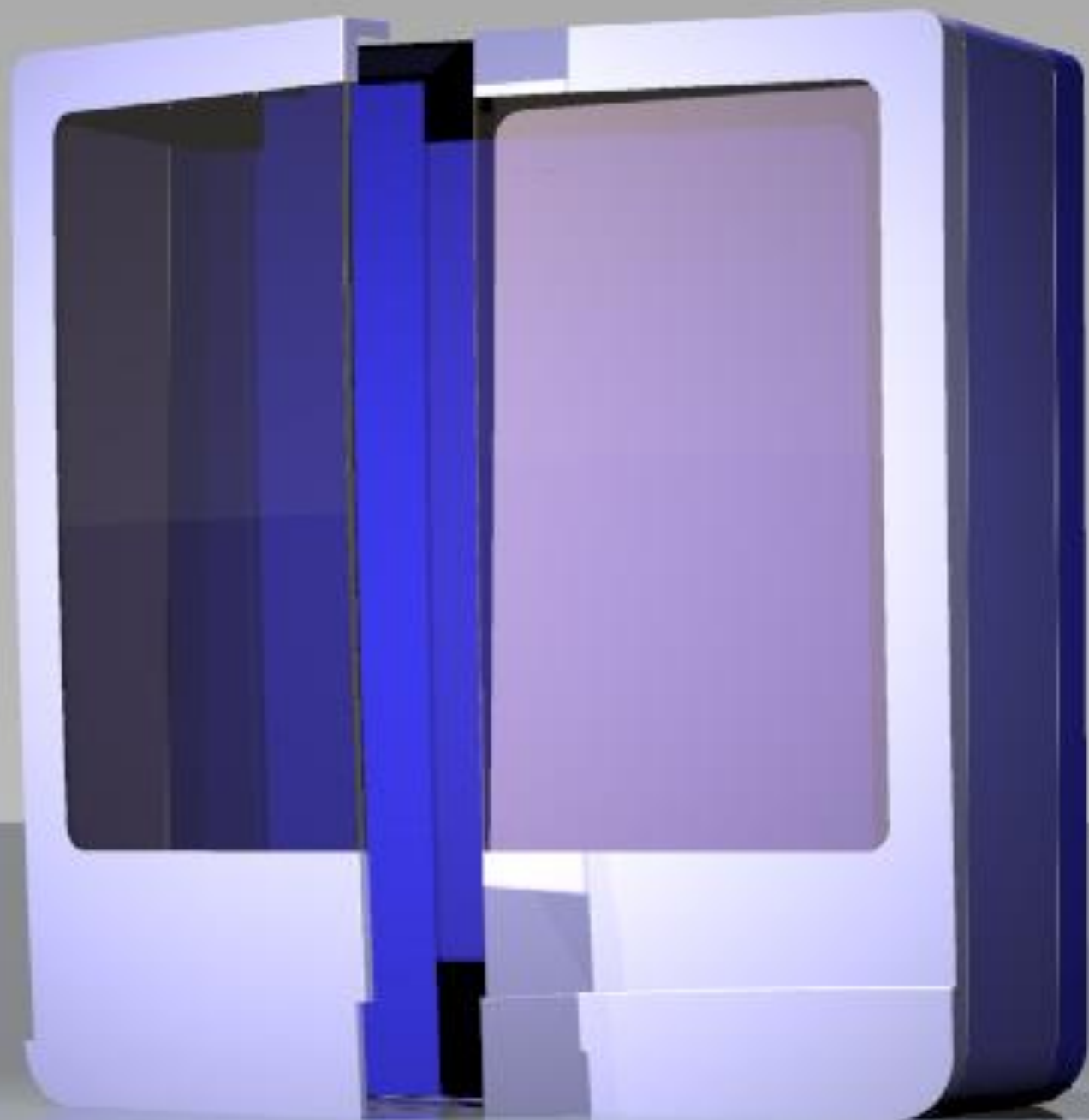

## Features of concept 4

- Split door that provides ease in opening and accessing the interiors
- Can be placed in any corner
- Transparent window that shows the inside and gives visual feedback.
- Appliance look is a lot sacrificed. So is the dishwasher look of an expensive gadget. Has started looking like a cabinet or a furniture piece.
- Sealing the door and still have the window transparent is a bit of a challenge.
- Dishwasher dispenser cant be located on the door and has to be moved to the interior side wall.



## **Form generation**

### **Category 5: Split door, horizontal**

I thought of splitting the door horizontally. The lower half opens down and the handle is on this part. As it opens down, the upper half of the door goes up. Even while closing only the lower door needs to be pushed up in place and the upper part would come down on its own with the help of mechanical linkages and pneumatics.

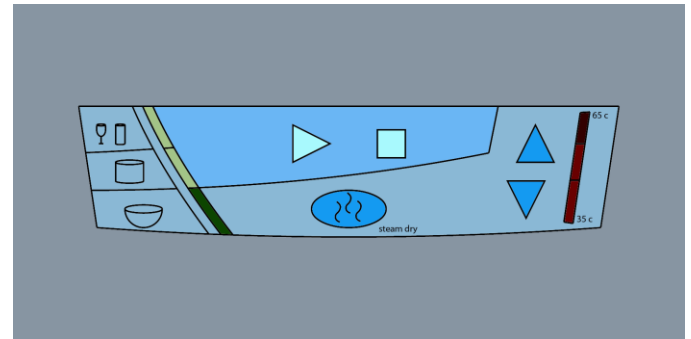
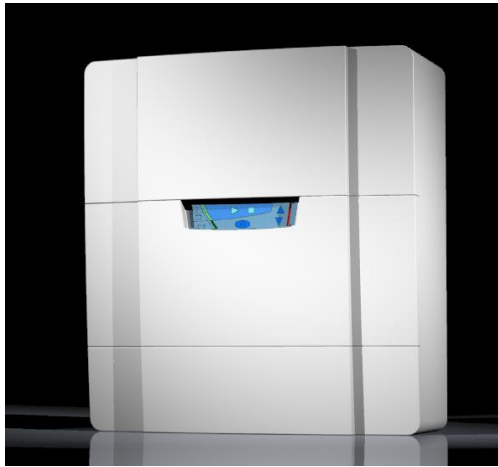

## Concept 5

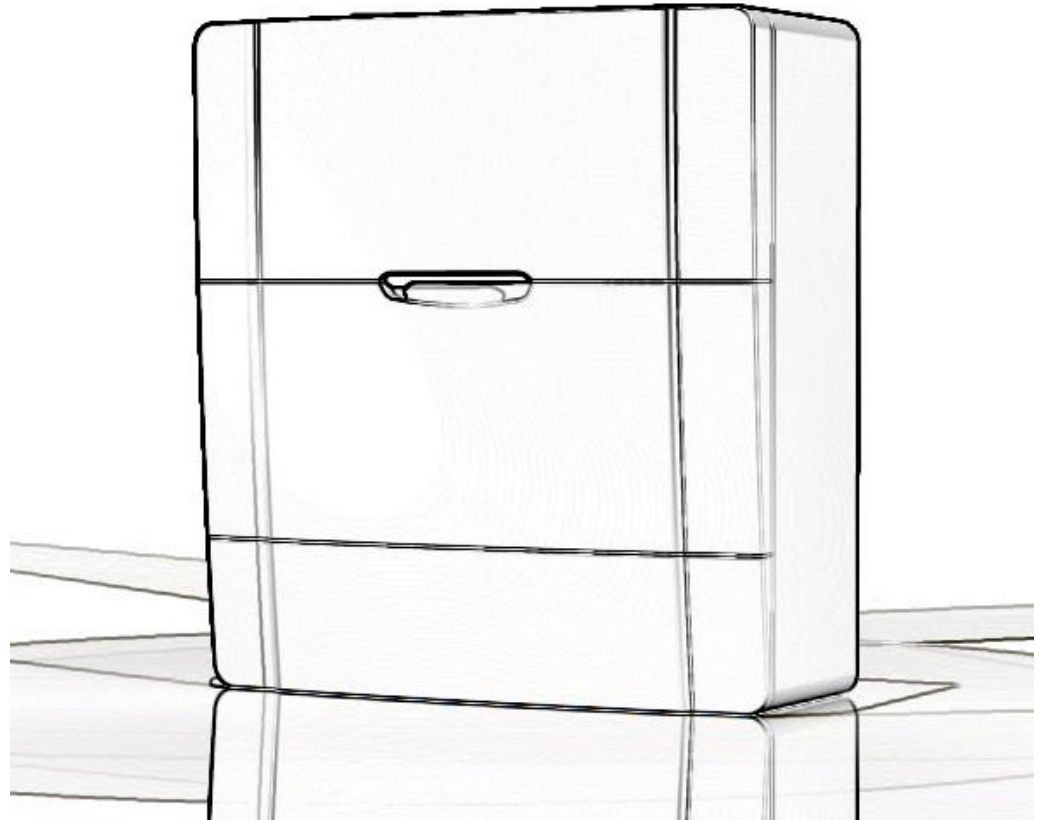

Taking clues from the explorations the vertical step was reduced to make it subtle and the split lines were made continuous. The idea of door handle was dropped. The control panel will merge with the surface instead of being in a recess



## Features of concept 5

- Horizontally split door that provides ease in opening and accessing the interiors
- Can be placed in any corner
- Appliance look is very prominent. So is the dishwasher look of an expensive gadget. Has started looking like a proper kitchen aid.
- As there is no transparent window, sealing the door is easy.
- Dishwasher dispenser can be located on the lower door and hence is easily accessible.
- The lower door can act as a temporary shelf while loading the dishes. If the dishwasher is not placed over the platform, near the sink, then this door will help contain the water that will run down from the dishes while loading them which otherwise would fall on the floor
- There is no window, so there is a lack of visual feedback

## Final Form Selection

	Concept 1 Single door opening on one both side	Concept 2 Single door opening on one side with window	Concept 3 Single door opening on both sides with window	Concept 4 Vertically split door with window	Concept 5 Horizontally split door without window
Ease of opening and accessing the dishwasher (10)	3	3	3	4	4
Looks, in terms of appliance-ness, dishwasher-ness and expensiveness (8)	4	3	2.5	2	4.5
Flexibility in locating (8)	4	2	4	4	5
Location of components (6)	4	2	2	2	5
Visual feedback (4)	-	5	5	4	-
Total	118	102	114	116	146
Rating	3.27	2.83	3.16	3.22	4.05

### Evaluation chart

Concept 5 scored the most and was selected for further refinement

This is the exploded view of the two steel door panels and the steel tub in which the rack is fixed. The steel tub had a step at the edge and the door panels fit into that step sealing it with a gasket in between.

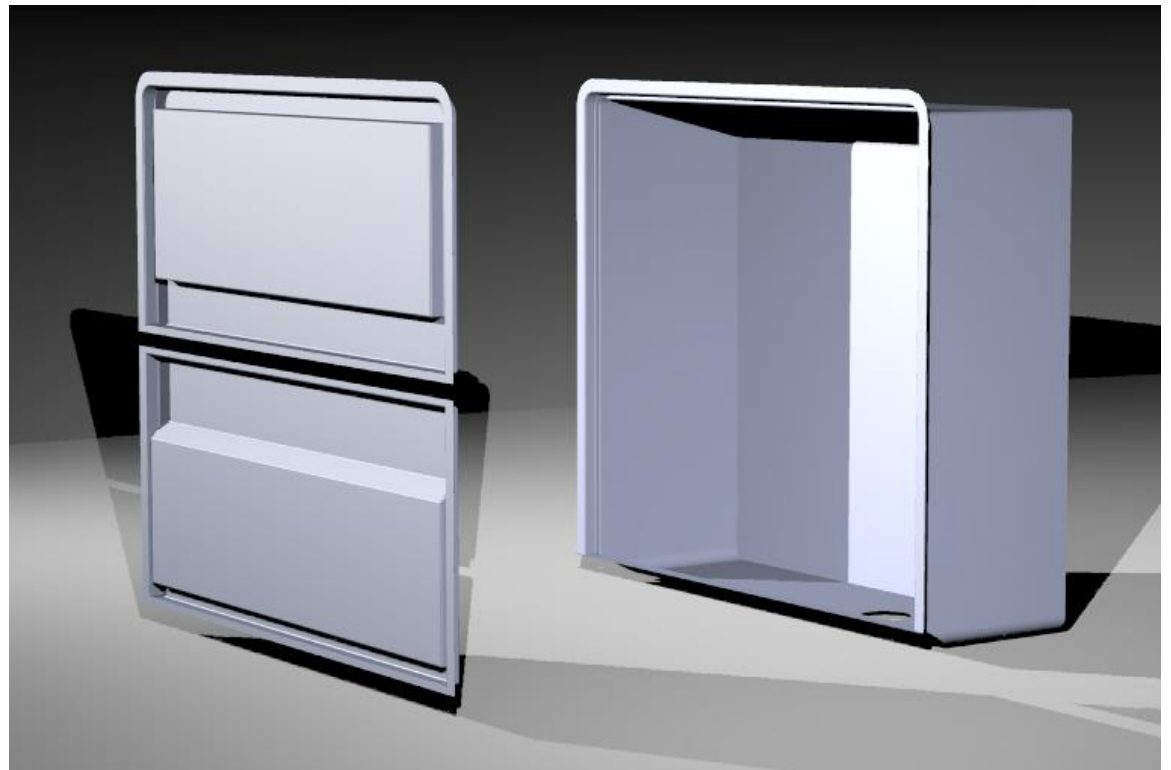

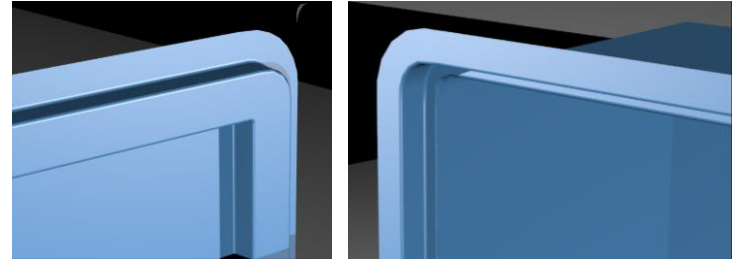

Close up of the door and the tub edge

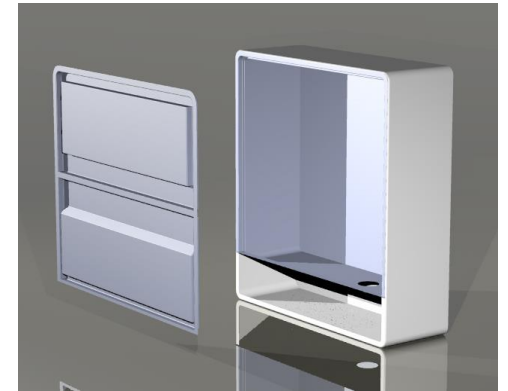

Steel tub fixed to the main plastic body

View of the steel door panel and the door plastic panel assembled together.

All the steel and plastic body parts

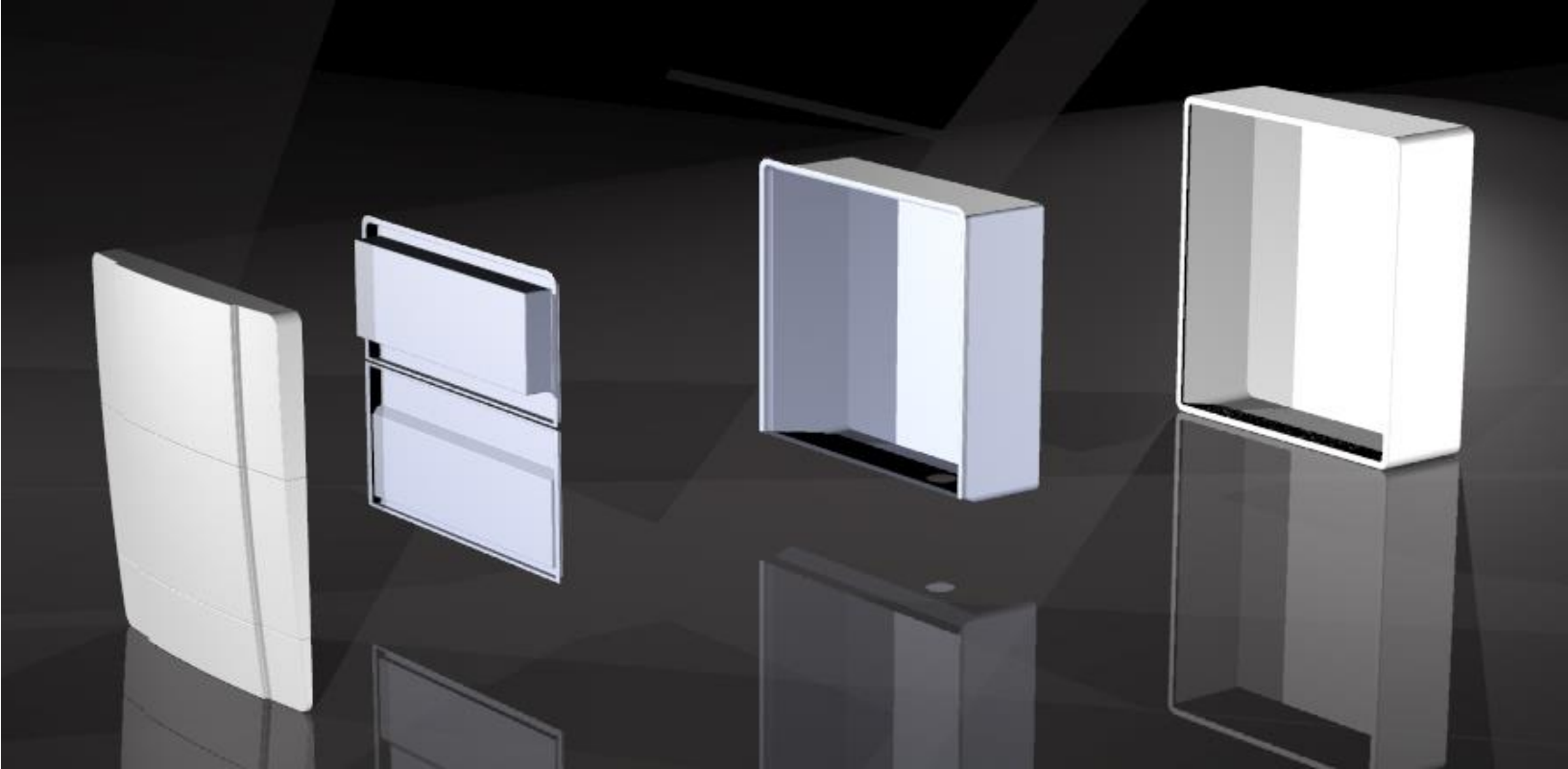

**The assembly**

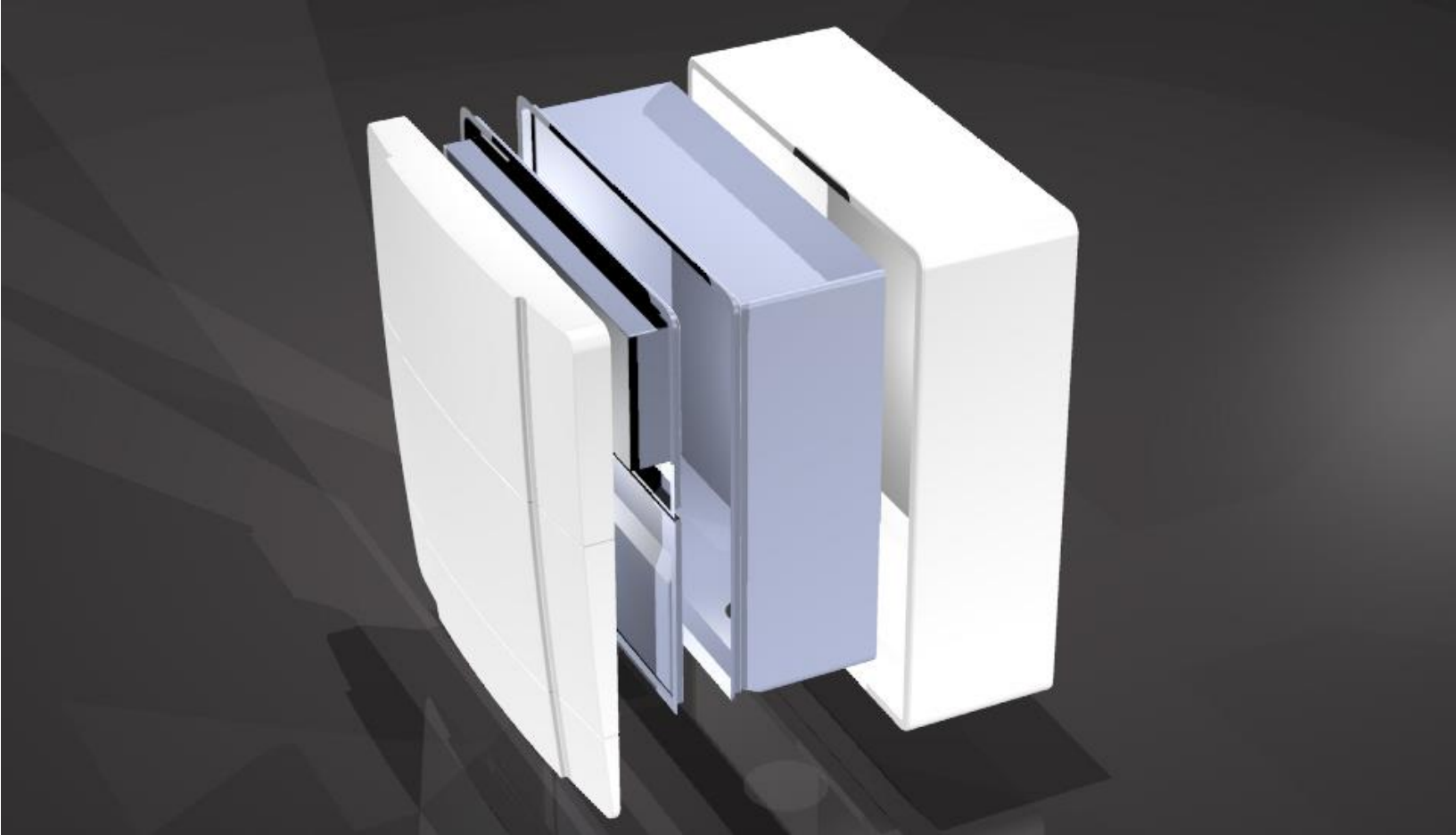

**The assembly**

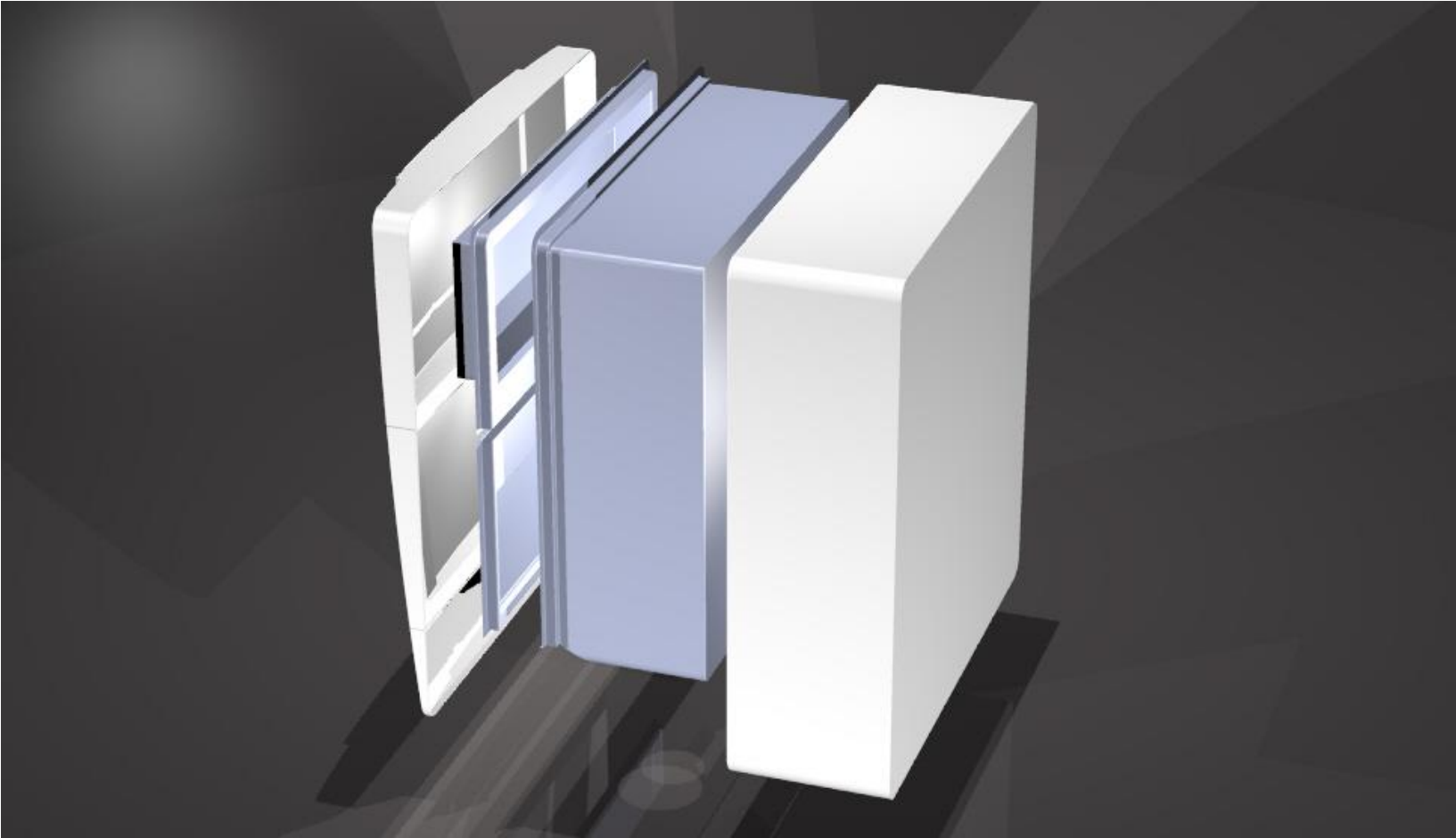

## Door opening mechanism

For the upper door to open up on its own when the lower door is pulled down the following linkage was designed. The arrows indicate the direction of travel of the door and the linkages.

As the lower door is opened in the direction of gravity, the linkage charges a pneumatic cylinder that later expands and assists in closing the door.

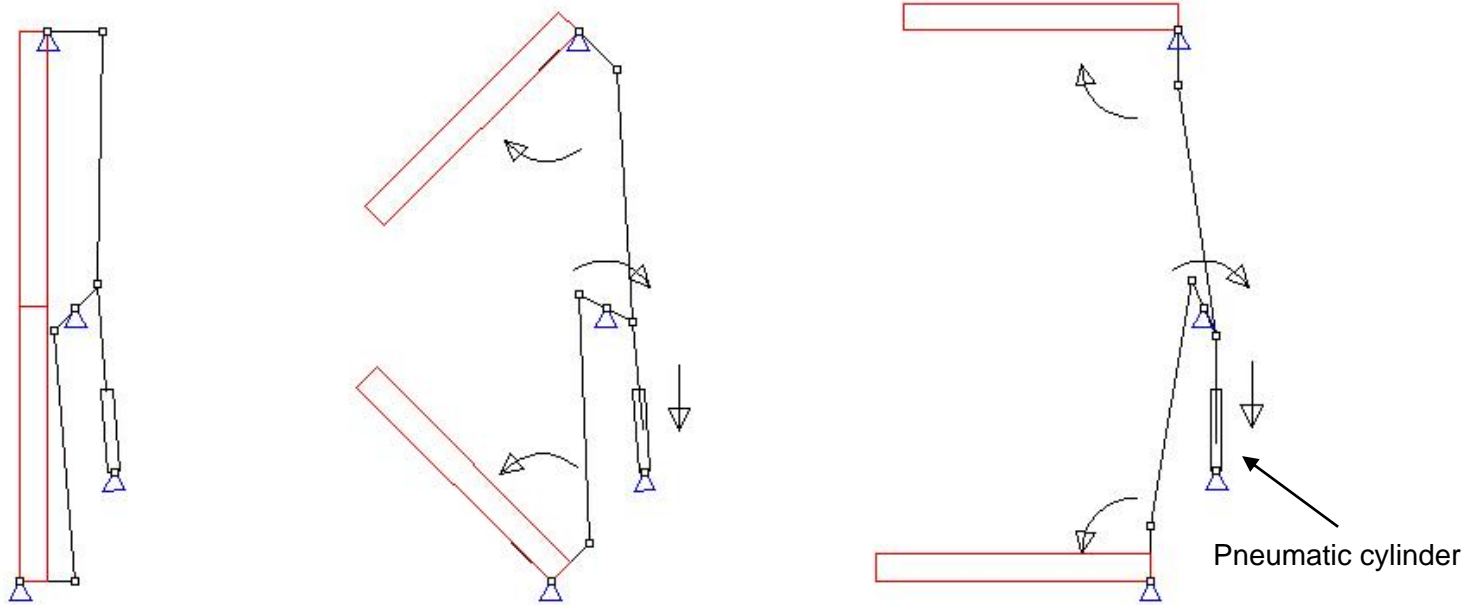

## Ergonomic analysis

The figure shows the analysis of two positions of attaching the dishwasher for a 50%tile indian woman.

Even in the extreme case where the dishwasher is put exactly above the sink all racks are reachable. The sink area will be a bit compromised but is very much accessible.

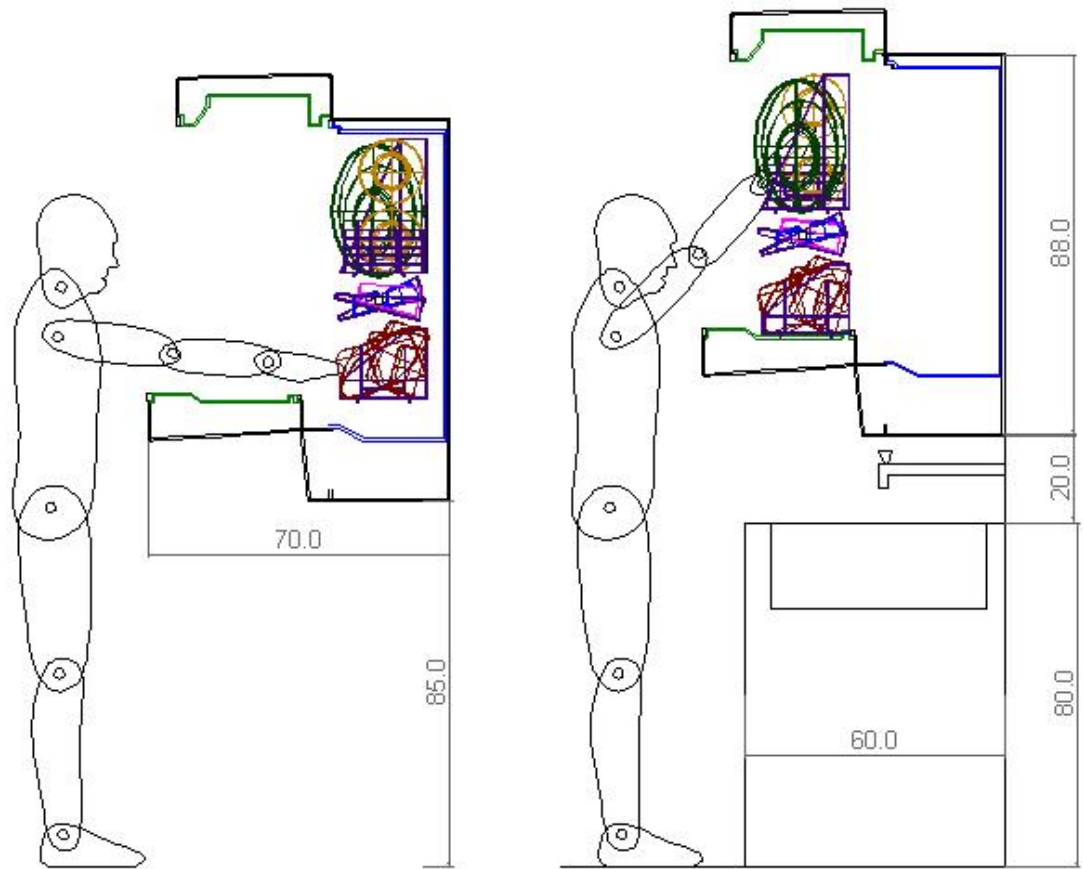

Sectional view

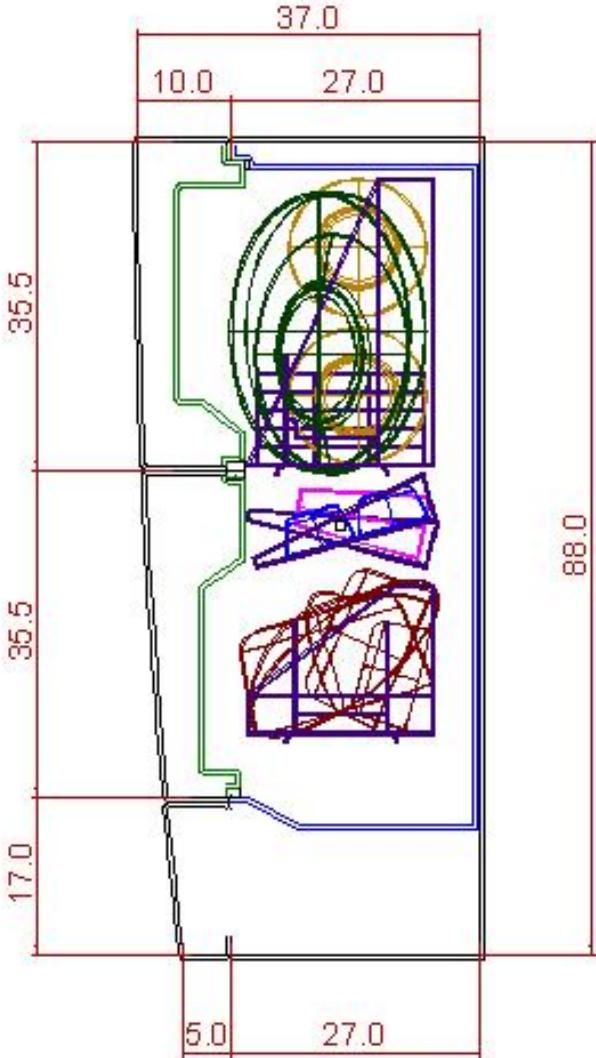

## Cost comparison

### **Maid**

250 per month per job once a day only

Detergents which are powder, liquid soap and vim bar- 100

Total 350 per month

### **Dishwasher**

Max electricity consumed per wash is 6 Rs/- worth per wash

That's 12 a day for two washes and 360 a month

Plus detergent that lasts for 4 months 125 to 150 Rs.

That's approx 40 Rs per month

Total 400 Rs per month

Hence if seen carefully there is a small price we pay in return of convenience and hygiene



Final model



