

DESIGN PROJECT 3 REPORT  
MOBILITY AND VEHICLE DESIGN

# DESIGNING AN ORAL HEALTHCARE VEHICLE FOR RURAL INDIA

HIMANSHU MUNDEPI

---

Guided by  
Prof Nishant Sharma

# CONTENTS

## *Table of contents*

1. Introduction	8
2. Background Study	14
3. Primary Research	33
4. Technical Insights	49
5. Design Packaging	59
6. Design Brief	90
7. Ideations and Concepts	93
8. References and Appendix	110

# The **Introduction**

Motivation and scope of intervention  
in the project

# 1

# MOTIVATION

## Dental Health Issues in India

*Extensive research in public health has shown that a number of individual, professional, and community preventive measures are effective in preventing most oral diseases.*

Dental diseases are a significant public health burden in India as well as across the globe. WHO recognizes the oral health as an integral part of general health. The consequences of widespread poor oral health can be seen on the personal, population, and health systems level, as caries and periodontal disease deteriorates the individual health and wellbeing, decrease economic productivity, and act as significant risk factors for other systemic health ailments.

*Why does oral healthcare in rural areas deserve a closer look?*

## Population Divide

*Many practitioners and institutions have tried to produce a solution for screenings and treatment. But due to the pandemic, these services render inadequate and ineffective.*

The divide spans across different geographic locations and demographic groups. The current Oral healthcare services and dental practitioners face a wide variety of issues due to this divide. While the Urban population is on the rise and the rural population is on the decline, there is still a wide gap between the two. Delivering healthcare facilities is a tough challenge.

**Majority of the Indian population lives in rural areas while most of the primary dental care facilities are only available in Urban areas.**

*There is much data to support the fact that dental health is an issue most prevalent in the rural India*

There is a concentration of only 10% of dentists where approximately 70% of the Indian population resides (rural areas) and 90% of concentration of dental professionals where only 30% of population resides (urban areas).

## Dental Health Issue

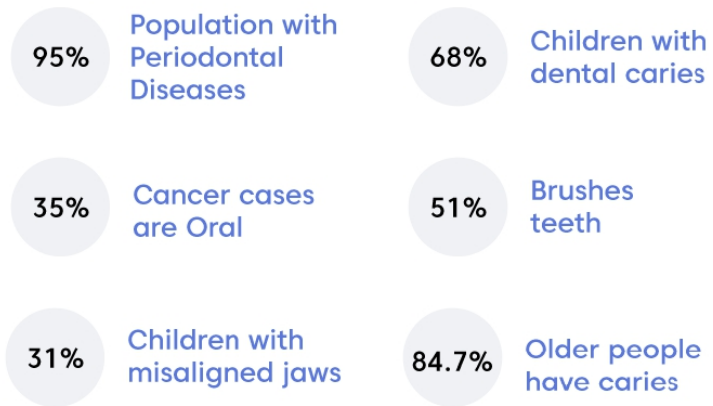

FACTS AND FIGURES

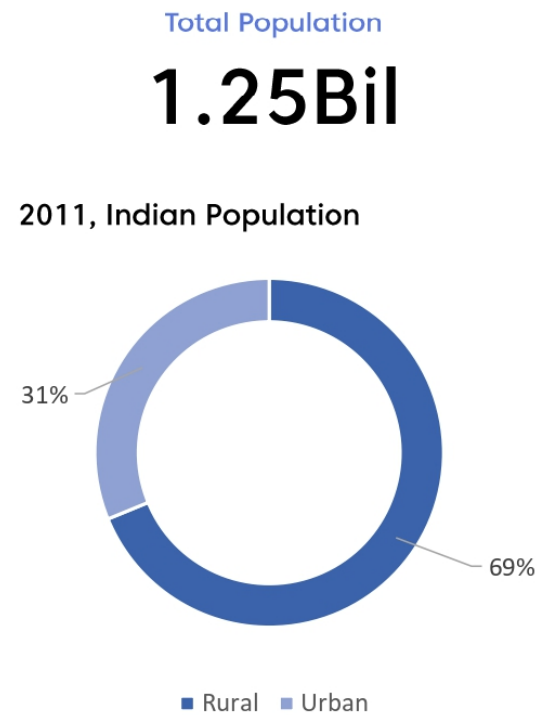

# SCOPE OF INTERVENTION

*Where can we do to make an impact?*

## **Lack of oral healthcare facilities**

*About 80% of dentists work in major cities catering to the oral health needs of around 31% of urban population. In rural India, one dentist is serving over a population of 250,000.*

The National Oral Health Policy that was drafted at the 4th Conference of Central Council of Health And Family Welfare in 1995 at New Delhi aimed at developing an efficient oral health care delivery mechanism to address the oral health needs of its countrymen remains as a draft.

## **Eliminating the need for street dentistry practices**

*A cost-effective and door to door option can deal with such practices. We can always provide formal training and absorb them in the healthcare system.*

Street dentistry, a form of quackery, is practiced mostly in rural and remote places of West Uttar Pradesh region of India. It is the practice of unproven, ineffective medicine, usually in order to make money, or to maintain a position of power. The procedures carried out by these quacks are very undesirable, harmful, and sometimes dangerous to the patients.

# Current Solution

## MOBILE AND PORTABLE DENTAL SERVICES

Portable dental units can be of advantage in places like **naturally isolated areas such as high altitudes or dense forests, defense and government programs, or disaster situations where mobile dental units cannot be transported.**

The successful implementation and execution of oral health-care delivery using the mobile and portable dental services rely on collaborative efforts of:

- Professional dental organizations
- Non-government organizations
- Government sector
- Local civil society.

*The scope of intervention with this issue relies on post pandemic considerations and identifying the shortcomings of previous solutions.*



# Shortcomings of the current solution

Mobile dental units are an effective solution to the oral health service providers like dental colleges and private practitioners.

**But the mobile dental units were not able to fill the gap between health care facilities provision and utilization.**

It was a promising solution but there were some impediments. Treating every villager for their basic oral healthcare needs in 1 day is nearly impractical. It is unethical to provide incomplete treatment in the hope to cover maximum population within a village or remote area.

Follow up treatments are almost impossible and only the treatment for those individuals who require emergency services such as extractions, pus drainage etc. can be carried out.

*Have mobile dental units been able to make an impact on the current dental healthcare system?*



**Incomplete coverage**



**Incomplete treatments**



**Manpower issues**



**Affordability issues**

01

Accessibility barriers, affordability barriers, lacking manpower

03

Inadequate and maldistribution of services

02

Geographic disparities

04

Incomplete treatments and poor coverage of the area



# Background **Study**

Getting a macroscopic view of the  
problem and identifying issues

# 2

# CURRENT SCENARIO

*What is happening in terms of Oral Healthcare for the public?*

## Public and Government Sector

*In 2020, the country achieved more than the ideal dentists-to-population ratio of 1:5,000, as against the 1:7,500 recommended by the WHO.*

- Minimal dental treatment is provided by government rural hospitals
- Basic dental treatment available at govt civil and district hospitals
- Drinking water goes under defluorination
- Anti-tobacco activities and awareness

## Private Sector dental healthcare

*Over 2.7 lakh dentists are registered with the Dental Council of India*

- Dental institutes offer treatment at low-cost except privatized practices
- Oral health awareness is promoted by pharmaceutical companies, NGOs and dental associations
- Insurance policies may or may not cover dental care procedures

# Solution

## Applications of the mobile and portable dental services

- Educating school children regarding oral health.
- Screening of the population for various oral diseases.
- School and community dental health programs.
- Providing both preventive and curative services in homebound settings.
- Dental services to people who are homeless, temporarily displaced or migrants
- Supplementing the medical services in case of any emergency relief situation or vaccination program.
- Educating and helping the new professionals to provide these services.

### A P P L I C A T I O N S

*The mobile and portable dental services have developed a distinct use*



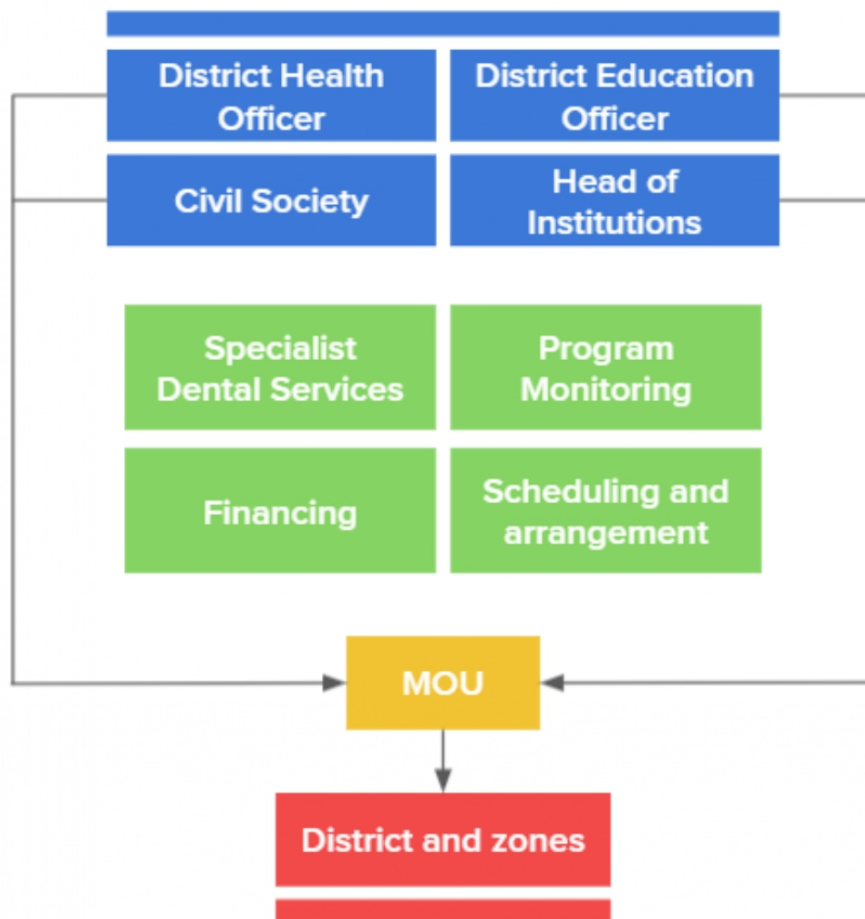

*Program developed to cover the underserved population in urban slums and rural areas*

## **Proposed model for oral healthcare delivery using mobile dental clinics for the population of a district in India**

Delivery model of healthcare services

As per DCI (Dental council of India) it is mandatory to have 1 mobile dental clinic per institution. With an MOU (memorandum of understanding) between institutes, NGOs, local civil bodies various programs are conducted. Villages and remote areas are then covered under the programs conducted through the MOU.

# Users and stakeholders

*Who are we developing the solution for?*

## Primary users in the dental healthcare system

Mobile and portable dental units are an effective and efficient way to take the sophisticated dental services to the doorsteps of the rural masses, school premises and urban slums through optimal utilization of dental institutions, dentists and dental auxiliaries. Identifying the users and stakeholders in this service is crucial.

### Practitioners

The dental care professionals



### Patients

People who require treatments



### Drivers

People driving the mobile units



### Assistive Staff

Assistive and technical staff



T A R G E T   U S E R S

## Evaluating the Mobile Dental Units based on studies

*Reviewing the ancillary services for especially underserved, hard to reach and remote areas*

When assessed, the evaluation of mobile health units tend to be formative in nature. These evaluations provide descriptive reports on the population using mobile health units, the types of services provided, and the outreach and service delivery strategies employed by these units for the “target” population, as well as report information on the perception of services received. However, such evaluations do not report on the outcome or impact of services. Formative evaluations of mobile health units have substantiated the assumption that providing educational and clinical services via a mobile health unit is a viable outreach method for accessing marginalized populations

STUDY	TREATMENT PROVIDED	BARRIERS	RESULT / REPOSE
Shobha Tandon et al.,	Oral screening and treatment	Accessibility barrier, affordability barrier, manpower issues	The mobile dental clinic proved to be an effective adjunct to the oral health service providers like dental colleges and private practitioners. They act as the first form of exposure to educate the rural people and alleviate their apprehensions towards oral health care.
Mulligan R, Seirawan H, Faust S	Questionnaire about children's access to dental care to assess role of mobile dental clinics in improving the oral health of migrant children.	Accessibility barrier	Mobile clinics provide a safety net for migrant children.
Douglass JM	Diagnostic and preventive procedures	Limited access to dental care, transportation problems and poor appointment attendance.	Innovative solution to bringing dental care to underserved children.
Rudolph MJ , Chikte UM, Lewis HA	Primary oral health care	Geographic inaccessibility, limited financial resources, and a maldistribution	Assessment of the MDU indicates that it is an effective and viable alternative oral health delivery system.

# EXISTING SOLUTIONS

*Vehicles currently used to facilitate the dental treatments*

**Various organisations and institutions have custom built coaches, vans and minibuses that are converted into mobile dental offices in India.**



1

Custom fabricated coaches built on bus chassis



2

Refitted minibuses and ambulances



3

Unconventional 2-wheeler solutions for medical services

## PARTS AND EQUIPMENTS HOUSED IN MOBILE DENTAL CLINICS

- Dental chair
- Overhead light
- Workstation
- Tools and equipment housing unit
- Operating stool
- Waste disposal unit
- Air con/ventilation system
- Battery packs/Generator unit
- Sinks and basins with water supply
- Oxygen cylinders
- Fire extinguisher
- Refrigeration unit
- Misc. equipment







# 1 Custom Built Coaches

## Custom fabricated coaches built to accommodate various facilities

- Built on bus chassis ranging from 6m - 10m in length
- Have 95 - 110 bhp engines producing approx. 300 Nm of torque
- Requires a team of staff to manage and run
- Can accommodate multiple procedures at a time due to higher capacity and work floor area
- Can house more equipment and facilities
- Can have various layouts according to the need
- Built on suggestions and preferences by medical professionals and practitioners



### SPACE

The large platform provides the users with ample space to work with, there is more room for customisation and storage facilities

*Custom fabricated coaches built on bus chassis*

# Layout1

*The layout of one of the custom-built coaches in use*

## Layout and floor plan of a general large Mobile Dental Clinic

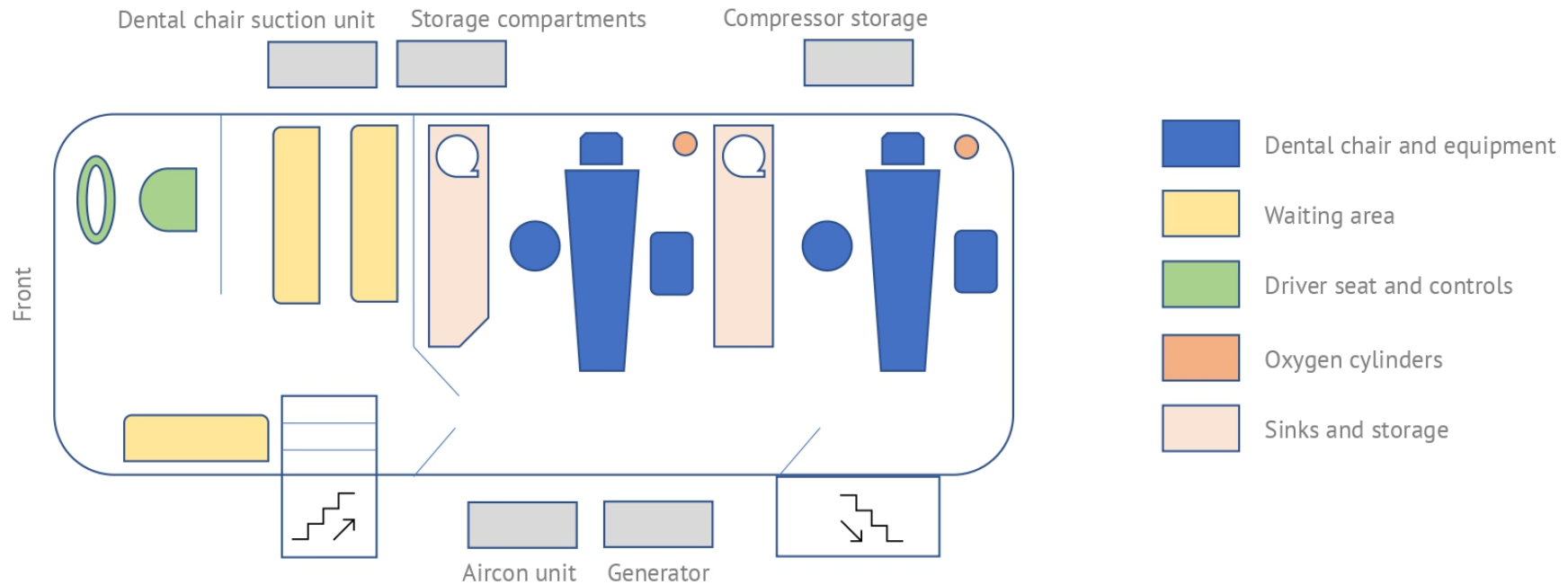

Dimensions and plan of a custom-built mobile dental clinic



*Custom fitted minibuses turned into small mobile clinics*

## 2 LIGHT COMMERCIAL VEHICLES

### REFITTED MINIBUSES AND AMBULANCES

- Vehicles like Force Traveller and Suzuki Eeco are refitted with the necessary equipment
- The vehicle is shorter in length at around 6.9m which makes it easy to maneuver through rural and remote places
- Houses a 90 bhp engine producing 250 Nm of torque
- Can be equipped with a single dental chair along with other equipment



#### **AGILITY**

The compact design allows for easier navigation through different terrains in a rural setting

# Layout2

*The layout of one of the custom fitted minibuses turned into small mobile clinics*

## Layout and floor plan of a general small Mobile Dental Clinic

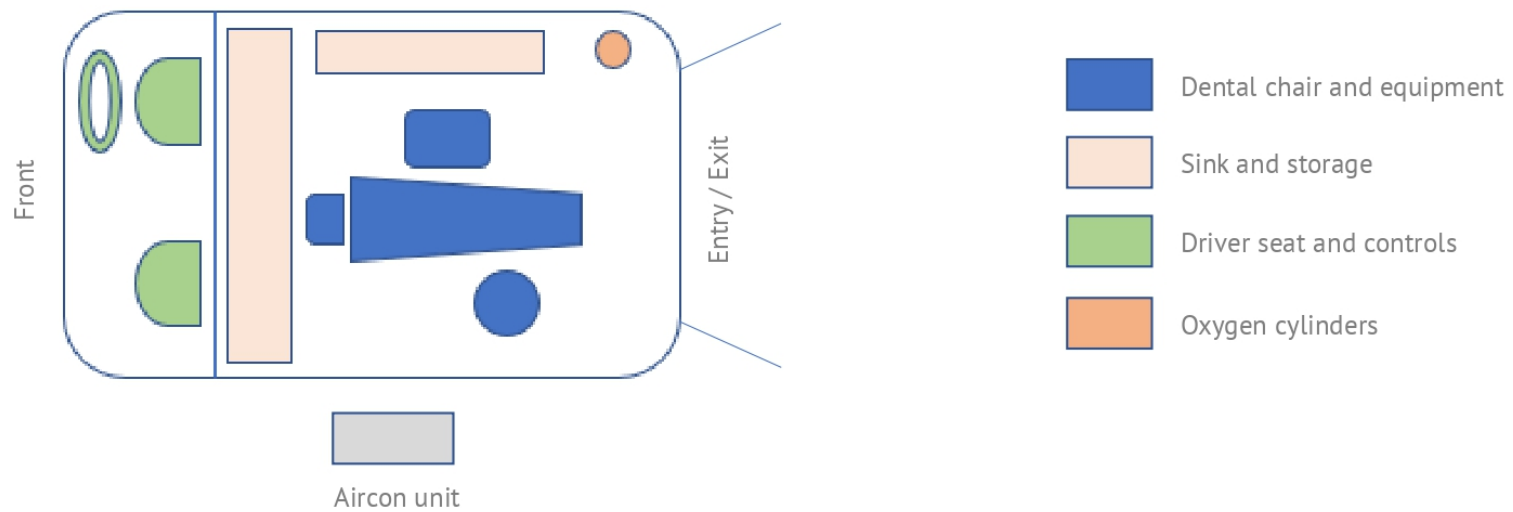

Dimensions and plan of a custom-built mobile dental clinic



# 3 TWO-WHEELER SOLUTIONS

## Customised motorbikes for medical assistance

- Built on 200cc motorbikes, this design provides a 2-wheeler solution for medical assistance
- Usually accompanied by a sidecar
- Can accommodate 1 patient at a time with limited oxygen supply and other amenities
- Can provide door to door assistance
- Cost-effective solution
- Facilities are limited
- Mostly operate in remote areas



### REACH

These mobile healthcare solutions on two wheels can be a good alternative as a dental health solution that goes door to door

# Dental work and fields

*There are different types of dental practitioners for specific dental concerns*

## Dental specialties and sub-specialties

### General Dentists

Provide regular teeth cleanings and routine dental exams as a form of preventive dentistry

### Periodontists

Help treat and repair diseases and problems of the gums

### Prosthodontists

Provide cosmetic dentistry to improve the appearance, such as teeth whitening, dentures and crowns

### Pedodontics

Specialize in dental care and treatments for children and youth

### Endodontists

Deal specifically with issues troubling the nerve of a tooth

### Oral and maxillofacial surgery

Deal with impacted and affected teeth and jaw/facial injuries

### Orthodontists

Specialize in teeth and jaw alignment, using wires, braces, retainers, and other devices

### Oral medicine and radiology

Deals with the use of X-rays for diagnosis and treatment of diseases or disorders of the mouth and jaw

### Public health dentistry

Deals with the prevention of oral disease and promotion of oral health

# Comparative studies of Dental Healthcare Facilities

*Examining, comparing and putting in contrast the dental healthcare facilities in different sectors*

<b>Privatised and high-end facility</b>	<b>Most facilitated</b> Privatized facilities are well equipped and can provide most types of treatments in a swift manner with a considerably cleaner environment.
<b>Institutional and educational facility</b>	<b>Adequate facilities</b> Institutes are required to maintain a certain code for educational purposes, they help provide all kinds of facilities to the patients.
<b>Rural and government facility</b>	<b>Insufficient facilities</b> Due to recent issues during the pandemic, these are the least serving facilities. There is a lack in quality and variety of equipment.
<b>Low-end and cost-effective facilities</b>	<b>Insufficient facilities with a frugal approach</b> Extremely low-end facilities in the villages or facilities provided by outreach programs are inadequate both in terms of services and only provide basic treatments.

# 1 Privatised and high-end facilities

## Private dental healthcare facilities that are well equipped

- Have a strong presence in Urban and semi-urban areas with ease of access.
- Mostly chosen due to the trust on the provider, quality of care, economic and physical access, timing and reputation.
- Well-equipped with latest electronic and automated controls.
- They have consultants and multiple departments to tackle different needs of the patients.
- Financially inaccessible to most low-income rural areas.
- Air-conditioned facilities with high-vacuum suction units to counter issues pertaining to the pandemic.

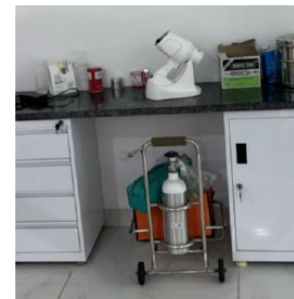

### Equipment

Almost all kinds of treatments are possible in such facilities. There are X-ray machines, suction pumps, dental kits and sterilization units available.



## 2 Institutional and educational facility

### Dental healthcare facilities at government and private medical and dental institutes

- Lower presence compared to the privatised facilities.
- Mostly chosen due to low cost and the wide variety of services provided at low cost.
- Contain most facilities with variable degree of care across different institutions with multiple department.
- Can serve a high number of patients but have mostly less/inexperienced practitioners and learning students.
- Provide the greatest number of facilities while being financially accessible.



#### Equipment

While most facilities and services are provided, some may be outdated or old. The facilities have the equipment in large numbers.



## 3 Rural and government facility

### Dental healthcare facilities in rural clinics and district/community hospitals

- Have a low presence in semi-urban and rural areas.
- Mostly chosen due to their reach and financial accessibility.
- Poorly-equipped with outdated and manual machines.
- They have consultants and multiple departments to tackle different needs of the patients.
- Inadequate infrastructure with worn-out and old equipment while also being understaffed.
- Majority of the facilities are closed due to government restrictions during the pandemic.



#### Equipment

Manually controlled equipment to save cost and maintenance. Contain basic equipment for preventive treatments.



## 4 Low-end and cost-effective facilities

### Healthcare facilities provided by NGOs, local practitioners and outreach programs

- Have a low and restricted presence in rural areas.
- Mostly chosen due to their financial accessibility.
- Poorly-equipped with outdated or low-cost equipment.
- Very few consultants that mostly serve the purpose of creating awareness and providing preliminary care.
- Inadequate infrastructure with worn-out and old equipment.
- Majority of the facilities are closed or ineffective due to government restrictions during the pandemic.



#### Equipment

Mobile or low-cost equipment that can setup at different areas and locations on a temporary basis.

# Types of dental services

*Understanding the types and levels of dental treatments provided*

Type	Feasibility in a mobile unit
Dental check-ups	Possible and most common in mobile units
Treatment - Scaling and Cleaning	Possible in most settings
Treatment - Filling	Possible in most settings
Referral to specialist for dental treatment	Possible and most patients are referred for further treatments and services
Dental implants and surgeries	Not feasible and requires multiple facilities
Treatment – Fitting of crowns, dentures, mouthguards	Not feasible and requires multiple facilities
Treatment – Tooth removal (extraction)	Not feasible but practiced in special cases
Treatment – Root Canal	Not feasible but practiced in special cases

# Primary **Research**

Understanding the pain points of the  
users and stakeholders

# 3

# Observational Studies

## Understanding the pain points of the primary users through observation

While mobile dental units are means to provide comprehensive oral health care which includes oral health treatment and education being provided to the underserved population at the same place and same time, they've some inherent issues across all platforms. Some of these issues were noticed while observing practitioners working in clinics and institutions.



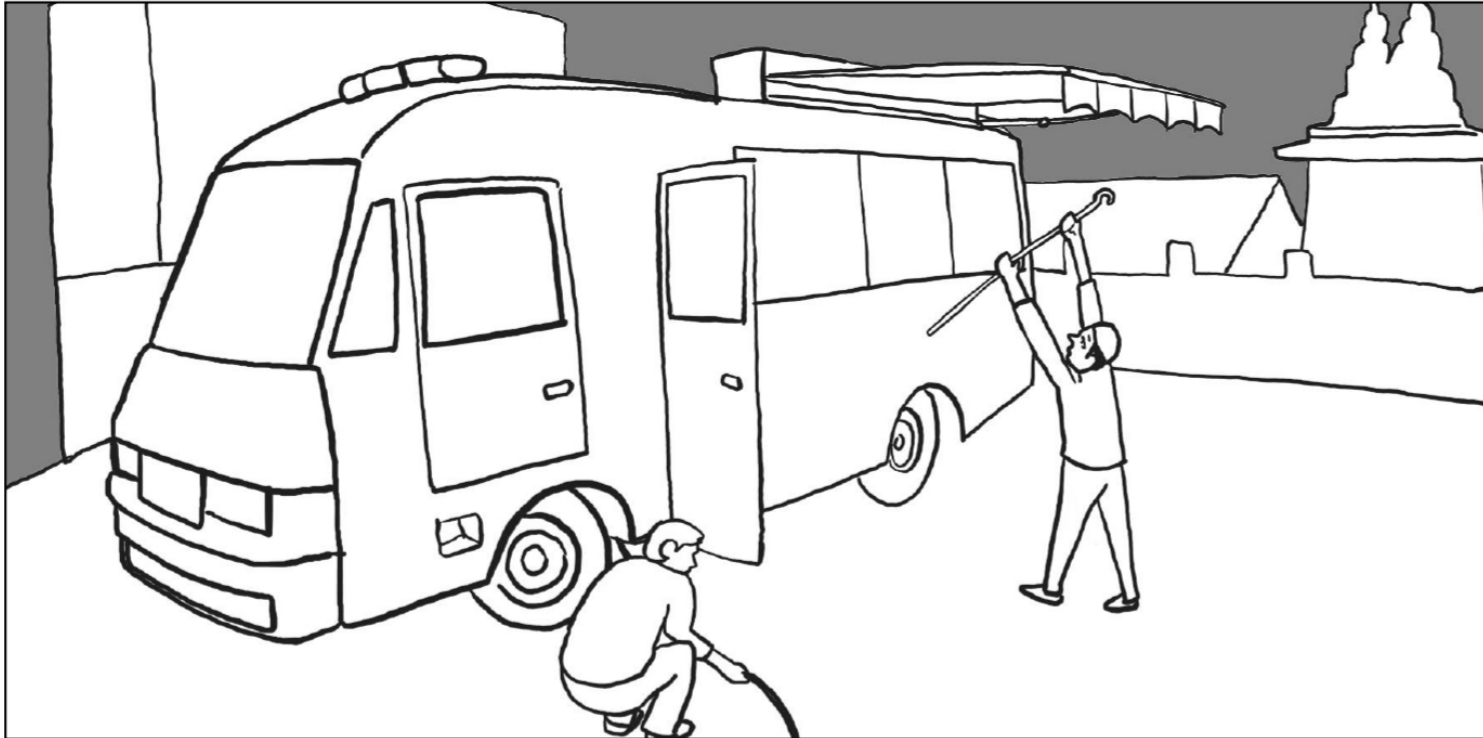

**Long and tedious process of setting up the mobile unit**

Setting up a mobile dental healthcare unit or taking part in an outreach program can be tedious. There are multiple amenities that are required. These need to be setup in advance or after approaching. The process required a large crew and a considerable amount of time.



### **Ergonomic issues while treating patients due to lack of space**

The treatment requires the practitioner to stand during the whole procedure. Walking around sinks, control pedals, tool trays, pipes, tubing and electrical wire connections for the entire to seek a perfect angle and view of the patient's mouth is a tedious task.



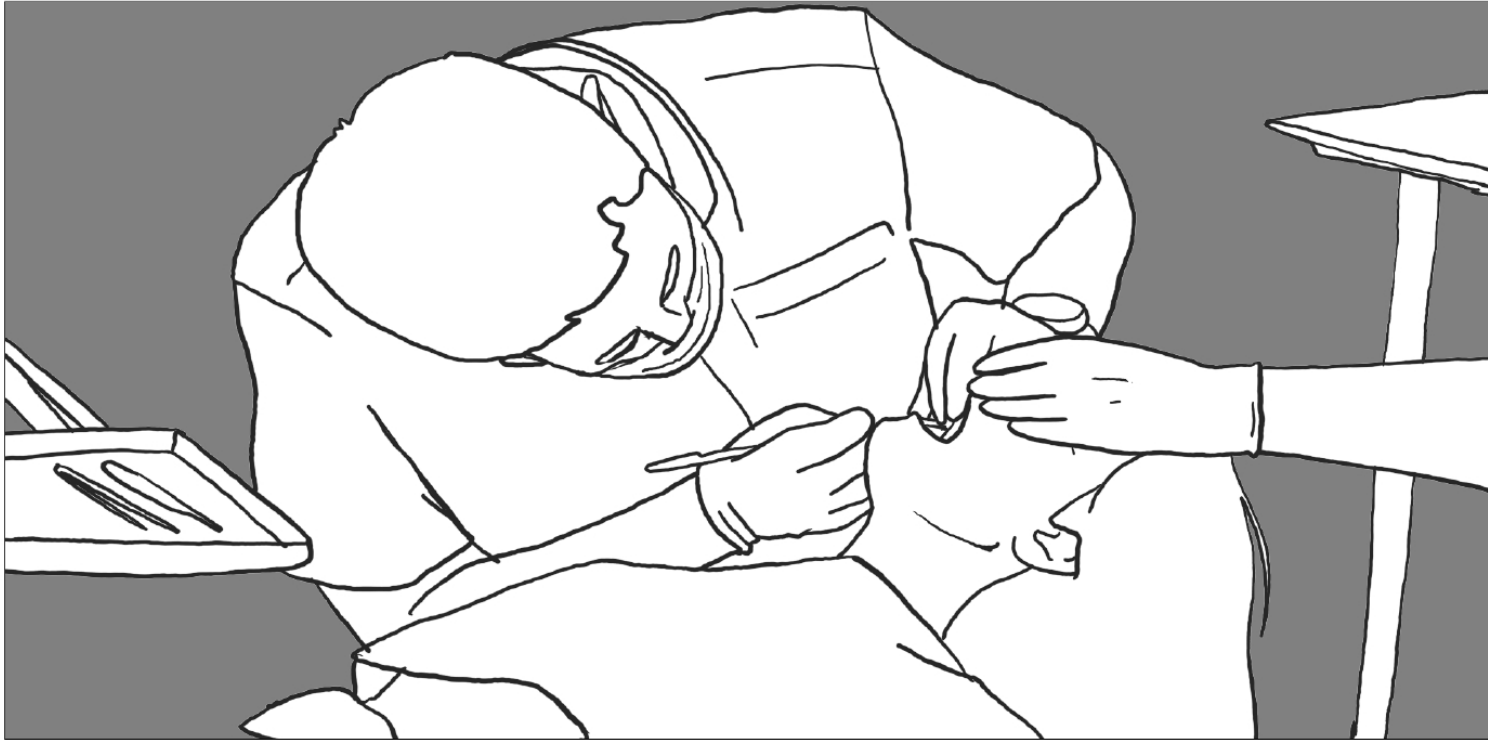

**Excessive amount of time spent standing while working with a bad posture**

The practitioner mostly has an uncomfortable postures with or without the chair. The dentist must stand up and walk around during the treatments and have their necks bent forwards or sideways to get a clear view.

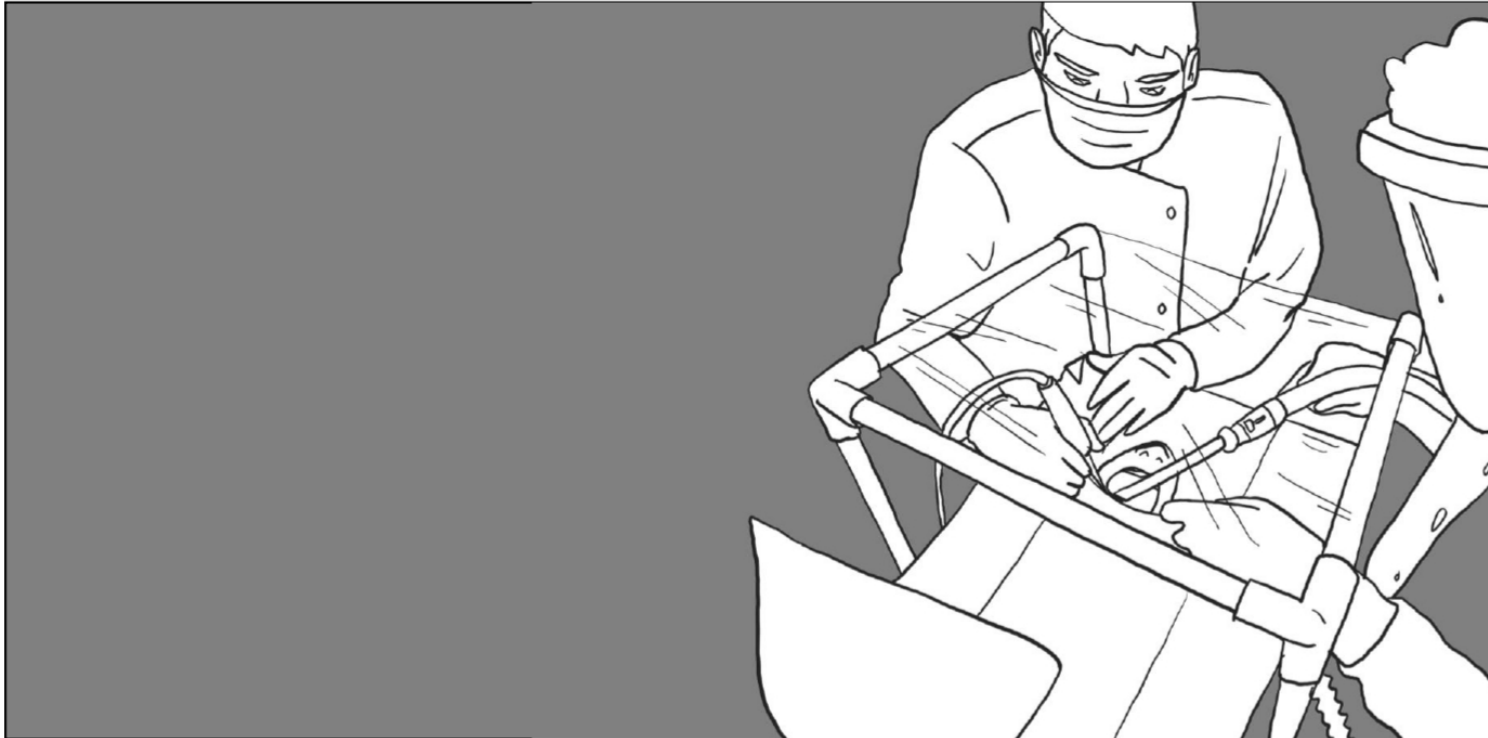

**Isolation and sanitization issues with lack of pandemic considerations**

While actions are being taken to address the sanitization issues the dentist is always in close proximity of the patient. The dentists seemed to be struggling with an isolated chair. High vacuum suction units are expensive and inaccessible in remote areas.

# Prevailing problems among patients

*The issues are exacerbated and become more pronounced due to certain factors*

<b>Burden of disease</b>	Considering the perception of low significance attached to oral ailments among the rural population, it is highly likely that the actual prevalence of oral ailments is be much higher and affecting various aspects of life.
<b>Health seeking behaviour</b>	Dental health seeking behaviour is found to be poor, a great amount of population do not seek care from a healthcare provider even when they are experiencing the symptoms. Resorting to home remedies or self-treatment using pain killers is also a common practice. Some major reasons are that it is very time consuming, very painful and involves long waiting time.
<b>Type of health care facility</b>	Since there is a lack of infrastructure, commitment and human resources in the government sector both in rural as well as urban areas, dental care is not part of most public healthcare facilities, people are forced to depend on private entities for healthcare.
<b>Awareness</b>	A significant aspect is the actual awareness and knowledge about dental health ailment and healthcare. The level of awareness is considerably low which influences perceptions towards dental care. The perception that dental health is insignificant also deters people from gaining more awareness about dental health and services available.
<b>Affordability of care</b>	In rural areas, for a country that is still struggling to institutionalize procedures such as childbirth, especially in rural areas, affordability of dental health services remains a significant issue both in terms of the way it is prioritized as well as the price of treatment that crosses the thresholds of medical expenditure of these low-income households.

# Questionnaire

## Important questions to be answered in a semi-structured format

### Purpose

The purpose of the study is to understand the barriers to uptake of mobile oral healthcare services among the rural population of India. This interview is aimed at understanding the trends and challenges that occur while providing oral healthcare in rural areas.

### SEMI-STRUCTURED QUESTIONNAIRE

#### 1. General Information

1. Name of respondent
2. Department
3. Designation
4. Qualification
5. Experience

#### 2. Product related / Situational Information

1. Do you have to personally drive/operate the vehicle?
2. What does your typical day look like on a field visit?
3. What are the primary concerns while going out to the remote areas to provide treatment?

4. What are the steps you take to prevent the spread of COVID19 in an enclosed environment?
5. How many trips do you make over a month/year when operating in Mobile Dental Clinics?

### **3. Qualitative Information**

1. What are your primary concerns/impediments when working inside the oral healthcare vehicle?
2. How is practicing dentistry different in a vehicle compared to a clinic/hospital?
3. Can you perform similar or more complicated treatments in the mobile clinics as compared to a complete facility?
4. What are the means of safety provided and have you been trained in basic safety exercises?
5. How do you manage the flow of patients in the vehicle?
6. How do they educate, aware and convince people to get treated in their mobile healthcare facility?
7. Do you face any health issues after or while working in the oral healthcare vehicle?
8. What is the most comfortable way of working when you're providing a treatment service?

# Interview Highlights

*Responses from dental practitioners working in and around the mobile healthcare units*



**Dr Shourya Tandon**

Professor & HOD

DEPARTMENT  
Public Health Dentistry

QUALIFICATION  
MDS, BDS, Cert Aesthetic  
Dentist, Cert Implantologist

EXPERIENCE  
11 years

## Notable points from the interviews

### Product related / Situational Information

The vehicle is not personally driven, most of the practitioners would not be inclined to drive their own healthcare centres. Generally, a typical visit requires a crew of 10 people. The areas that need to be visited are scoped out and prepared in advance and the availability of basic facilities like water and electricity is checked.

### Qualitative Information

Dentistry is very restricted in Mobile Units due to lack of equipment and contamination concerns, even a closed vehicle is not fit for complex treatments. The mobile units are majorly used for diagnosis and preventive treatments and to raise awareness. Almost all patients need a follow up treatment but that is hard to achieve.

### Desired experience

An ideal experience would be able to sit down and work on the patients. The practitioner is now more accustomed to standing while working due to the current design of the stools and chairs. It would also be ideal to have follow up procedures on the incoming patients.

### Pain points

The current number of trips fall under 100-150/year which are insufficient to cover up a larger area and to have follow-ups with the previous patients. Cervical along with needlestick injuries is a major concern.

# Interview Highlights

*Responses from dental practitioners working in and around the mobile healthcare units*



**Dr Sachin Chand**

Reader

DEPARTMENT  
Public Health Dentistry

QUALIFICATION  
MDS, BDS

EXPERIENCE  
7 Years

## Notable points from the interviews

### Product related / Situational Information

Assistive crew and technical staff is always needed on the trips, and it is not feasible to drive on your own or work with a small crew. Some of the primary concerns with these visits are the lack of resources and not being able to document the patients. Mask, PPE kits, High-vacuum suction devices are some of the measures being taken to prevent covid.

### Qualitative Information

The primary concerns while working in a vehicle is being exposed to the same air as the patient. The closed vehicle provides an isolated environment but there is not enough space to carry equipment that keep the flow of air enough to prevent being exposed to airborne diseases.

### Desired experience

An ideal experience would be to have all the required equipment in an isolated environment that is safe for both the doctor and the patient. Having a vehicle with multiple consultants with their facilities from different departments will help provide a better and complete care for more serious dental issues.

### Pain points

Neck and back pain have become part of the job, exposure to airborne diseases. Mental health issues were prevailing due to restrictions, social and physical distancing, fear of contagion among financial insecurity and potential loss of income.

# Interview Highlights

*Responses from dental practitioners working in and around the mobile healthcare units*



**Dr Sheetal Rohiya**

Tutor

DEPARTMENT  
Public Health Dentistry

QUALIFICATION  
BDS

EXPERIENCE  
1 Month

## Notable points from the interviews

### Product related / Situational Information

A typical day on the field consists of reaching the location, setting up the vehicle, diagnosing the patients, providing treatments or referrals, managing the staff, basic documentation and wrapping up to leave the facility. On school visits the working hours are shorter due to the school timings and the routine is slightly different for each visit.

### Qualitative Information

Working with large number of people and staff, managing the crowd and flow of patients are some of the major impediments when working from a mobile clinic. It is also hard to provide all kinds of treatments to the patients, only in emergency situations the patients undergo an extraction or other high-level treatment.

### Ideal experience

Having lumber support will help with treating patients for a long time. The setup for the vehicle should be less tedious and the vehicle should be able to reach into remote locations as currently the vehicles sit at major hotspots gathering people from nearby areas.

### Pain points

Treatments that go on for long durations can be tiring as the dental healthcare personnel has to stand through the entire treatment which can range from minutes to certain number of hours. Physical pain is a major issue after most treatments.



# Key Insights

*Key insights derived from the interviews and recognizing the actions needed to get the desired experience*

Key Insight	Desired Experience	Impediments towards desired experience	Actions to mitigate impediments
The mobile units require a large crew while they sit at one place and cater to a small population	An ideal experience would be to have a larger reach into the community	Large vehicles are cumbersome to setup and require adequate space to function	Smaller vehicle with only a few crew members that can provide treatment across streets
Dentistry practices are restricted to diagnosis, basic treatments and raising awareness	A better and complete care for most dental health issues	Inability to carry multiple equipment and not having a completely isolated environment	Having a vehicle with multiple consultants with their facilities from different departments
Dental healthcare personnel face physical health issues due to restricted space and bad posture for long durations	Being able to sit and work on the patients without having to deal with the dental chair arrangement	Large dental chair with various tools all around it doesn't encourage the practitioner to sit in one position	An adjustable setup that helps with a better view of the mouth from a comfortable sitting position and easy access tools
Incomplete documentation and recordkeeping along with constant mobility leads to lack of follow ups with patients	All dental treatments require a follow up, being able to follow up with previous patients will lead to satisfactory results	Fewer trips for a short duration to remote rural areas with poor dental health seeking behaviour	Providing a complete and satisfactory treatment by being available for a longer time, satisfactory results will lead to the understanding of significance of dental health services

# User persona

## Dr Gurpreet Kaur

Haryana | Female | Unmarried | 35 yo | Public Health Dentistry Professor

Dr Gurpreet Kaur is a public health dentistry professor at a private dental hospital. She loves her work and has been successfully running a few public health outreach programs for the institute. She is an outgoing person who loves to paint and write. She has published 2 papers on the need for dental health awareness in rural India. She is dealing with constant back and neck pain due to her practices and teachings. She drives to her workplace and goes on road trips with her friends. She has a big circle of friends and followers on her social media and her medical blog.

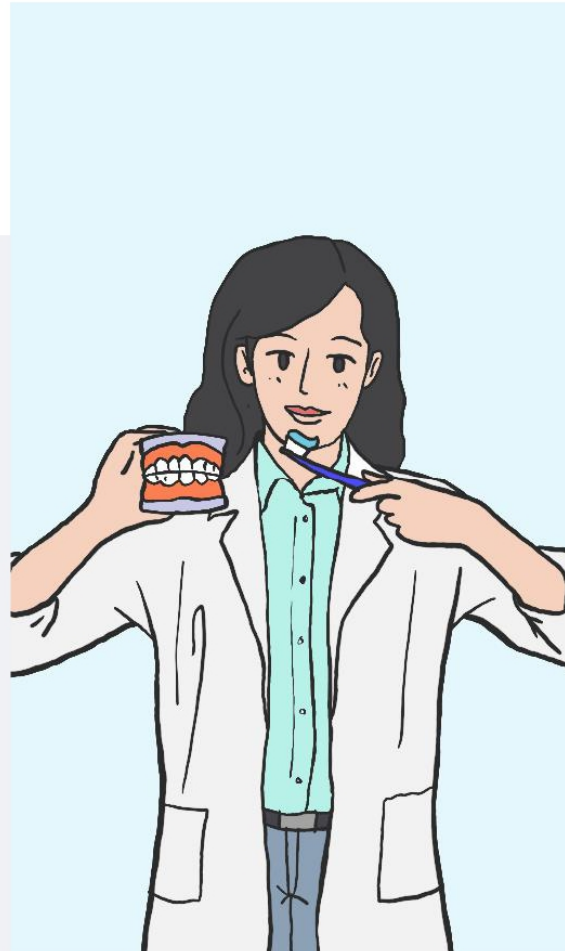

*The user persona is derived from the various dentists working in the field of public healthcare*

**Gurpreet Kaur**

*35-year-old Dentist from Haryana*

# INFERENCES

*Conclusion from the preliminary research*

## Assessing the current scenario

### Challenges?

Inadequate coverage and incomplete treatments are two major challenges. The current mobile dental units are not able to fulfill the needs of the masses in rural areas.

### What makes sense?

The focus of the mobile dental clinic is to raise awareness. They effectively work at educating and helping the new professionals to provide these services. They are accessible to the people from all walks of life

### What are the issues?

Platform, cost, affordability, manpower are some of the primary issues. The older solutions are not equipped taking the COVID-19 pandemic into consideration.

### Which platform works?

A platform that can provide low-cost, door-to-door, repeated assistance and service for basic dental care needs is the platform that can succeed on the current model.

# Technical **Insights**

Understanding the technical  
details and requirements

# 4

# Subsystems

The major subsystems in the vehicle



**Powertrain**

Power source for the vehicle that helps operate in desired scenarios



**Wheels**

Appropriate wheels and sizes for the vehicle



**Chassis**

The base structure that the vehicle will be built around



**Components**

There are many variations of but the majority believable.

# 1 Powertrain



## IC Engine

With an IC engine we can provide a higher power output that can help carry a large amount of load.

The solution is heavier, costly and requires more maintenance.



## Electric Motor

It is an efficient and reliable solution for the powertrain as it is cleaner, easier to maintain and light in weight.

Electric motors that output the same amount of power as their IC counterparts are expensive and require heavy battery packs.



## Human powered

A human powered solution is efficient, effective and a easy to maintain with extremely low cost.

Heavier loads and covering large areas is nearly impossible with a human powered solution.

Power source for the vehicle that helps operate in desired rural scenarios

### Problem One

Lack of electricity and unreliable charging facility in the rural areas

### Problem Two

Multiple components are required to be transported and hence add a lot of vehicle to the vehicle

### Problem Three

Personnel travelling already deal with fatigue and physiological stress

# 1 Powertrain

## Compact Gasoline Engines



### Powertrain

Type: Single cylinder 4 stroke petrol engine

Capacity : 200-236.2cc

Power output: 7.6 kW at 4500 rpm – 9.9 kW at 5500 rpm

Torque output: 19.2 Nm at 3250 rpm – 19.6 Nm at 4000 rpm

Clutch: Wet-multiplate

01

SI Engines burns fuel in an eco-friendlier manner as compared to CI engines

02

Petrol engines are more economical and efficient as compared to diesel engines

03

Petrol engines are more powerful in terms of power output

# 1 Powertrain

## Compact Diesel Engine



### Powertrain

Type: 4 Stroke Compact Diesel Engine

Capacity : 470cc

Power output: 6.25 Kw at 3000 rpm

Torque output: 24 Nm at 1800 rpm

Clutch: Dry-single plate

01

Diesel is the most widely used petroleum-based fuel in India, accounting for 40% of total use.

02

Diesel is widely available in rural areas as agricultural sector is the second-biggest consumer of diesel after transportation.

03

Easy to maintain as compact diesel engines are common throughout India

04

The engine provides enhanced load bearing capacity and better pick-up



## 2 Wheels



### Small size (10"-14")

Provide a comfortable, cost-effective ride in Urban scenarios at lower speeds with greater maneuverability.



### Medium size (15"-17")

Provides higher stability and control over poor road surfaces and low to medium speeds. These wheel sizes can better span holes in the road surfaces.



### Large size (18"-21")

Has moderate maneuverability capabilities but require more space. They are stable and can handle most terrains.

Size and category of the wheel to be chosen for the vehicle

Choice of the wheel size depends upon the road surface, weather conditions, the temperature outside and load on the vehicle

#### Factor One

The vehicle is intended to be used on rural roads with uneven terrain and poor surface quality

#### Factor Two

The wheels are supposed to provide greater maneuverability and space for the equipment

# 3 Chassis



## Integral Body Frame

The frame provides safer and easy to repair chassis design that has superior torsional rigidity over other types of frames

It is heavy as it integrates both frame and the body while also being expensive to manufacture



## Tubular Chassis

Offers the best weight/rigidity ratio allowing the vehicle to be lightweight while being strong

Time consuming and complex structures to manufacture

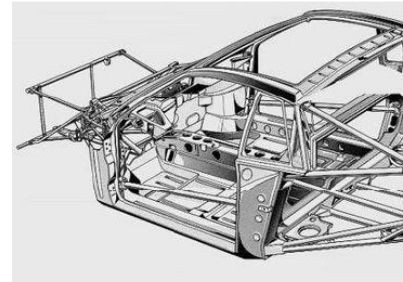

## Hybrid Design

Easy to produce design that offers adequate structural stability as the subframe serves as mounting points for the various components while space frame provide additional structural support

The chassis itself may twist between the sub-frames which can be remedied by braces and connectors

Exploring the structure that is going to support the personnel and the wide variety of equipment

### Problem One

The structure needs to support and carry heavy equipment along with dental professionals

### Problem Two

The structure needs to be cost-effective and minimal, providing the practitioners enough physical space to work around the vehicle

## 4 Equipment



*Dental chair with Oral lamp*



*Suction pumps*



*Various dentistry tools*



*Cuspidor*



*Tool tray with controls*



*Ultrasonic scaling equipment*

# Dental Chair



**High End automated dental chair**

Commonly used in dental clinics and large mobile dental healthcare units these provide a wide variety of equipment and stability. Can provide articulating headrests, massage systems, built-in heaters, and touchpad controls.

These dental chairs are extremely expensive and bulky in nature and require additional power sources and motors to operate.



**Low-cost portable dental chair**

Designed for mobility, this chair is light and highly cost efficient. It can feature compact and portable equipment.

The design is not ergonomic and has to deal with dirt and grime. Degree of movement is majorly restricted and often comes with a certain load limit.

## Factors to consider when choosing dental chairs

The dental chair is the focal point of a dental clinic. An ideal dental chair provides:

- Stability – the chair needs to maintain its position throughout the dental procedure
- Good quality of material – the chair needs to be rust and chemical resistant
- Comfort – Ergonomic comfort for both the patient and the dentist
- Functionality – Ease of setup and the degree of freedom in movement and control of the chair itself

# Suction Pumps



## Compact Low Power Suction Pumps

Works as a saliva ejector  
0.25-1.5HP motor  
Compact in design  
More affordable

Weak suction power  
Limited resources that need  
constant refilling  
Blockage is a common issue



## Central/Normal Vacuum System

High volume suction removes saliva  
and dental debris  
1.5HP and above motor  
Significantly enhanced suction power  
Provides multiple filters to prevent  
diseases

Heavy equipment that requires high  
maintenance  
Extremely high in cost

### Factors to consider when choosing suction machines

An integral part of dental clinics, the suction pump:

- Should provide comfort to the patient as it clears out anesthetics, saliva and debris
- Clear out debris easily
- Helps the dentist keep track during the surgery with a clear view
- Keeps the mouth and teeth dry
- Removes exhaled air keeping the environment sanitary and safe

We require a unit that can provide appropriate comfort while being compact and cost effective.

Design  
**Packaging**

Placement for the essential  
components of the project

6

# Packaging Ideations

Various formats in which the components can be placed

## Exploring the possible packaging solutions

Various solutions provide various degrees of freedom with varied cost effectiveness.

Exploring all the possible solutions and creating a comparative will help towards a refined solution.

### PACKAGE 1

Human Powered  
Tandem Clinic

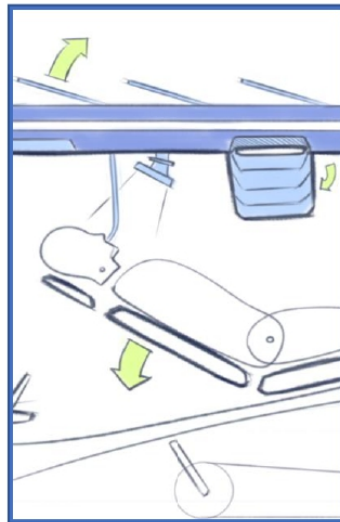

### PACKAGE 2

Compact 3-Wheeler  
Modular Clinic

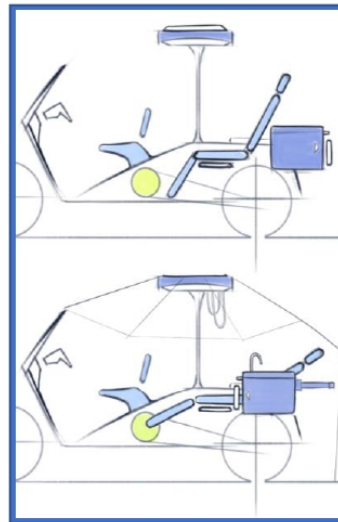

### PACKAGE 3

2-Wheeler Assisted  
Carriages

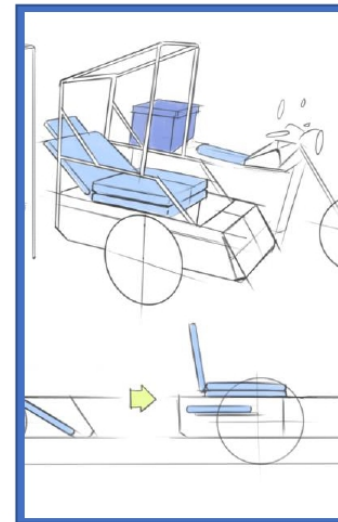

### PACKAGE 4

3-Wheeler Integrated  
Dental Clinic

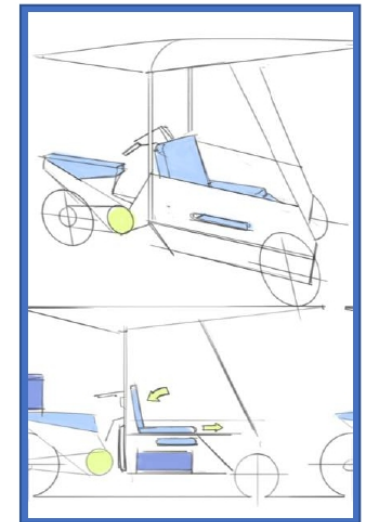

# Package 1 : Exploration

## Human Powered Tandem Clinic

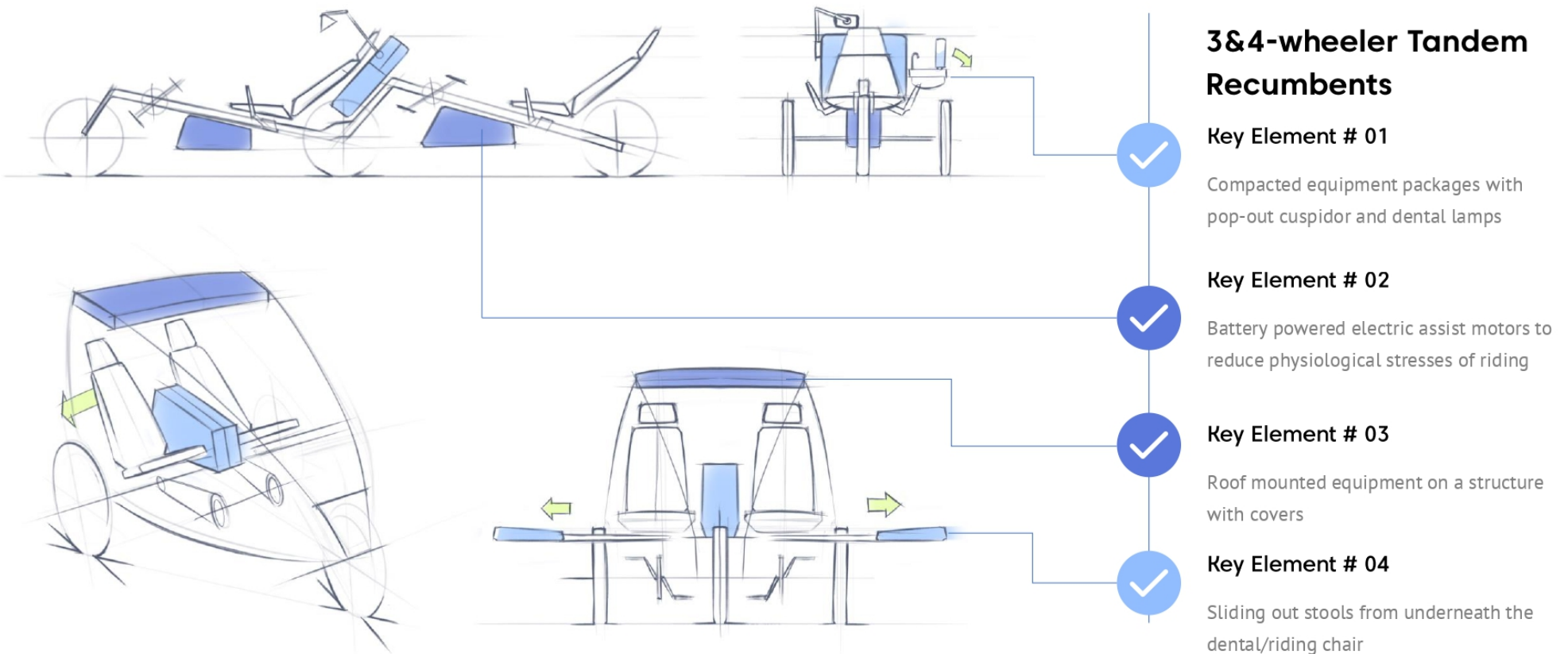



# Package 1 : Exploration

## Human Powered Tandem Clinic

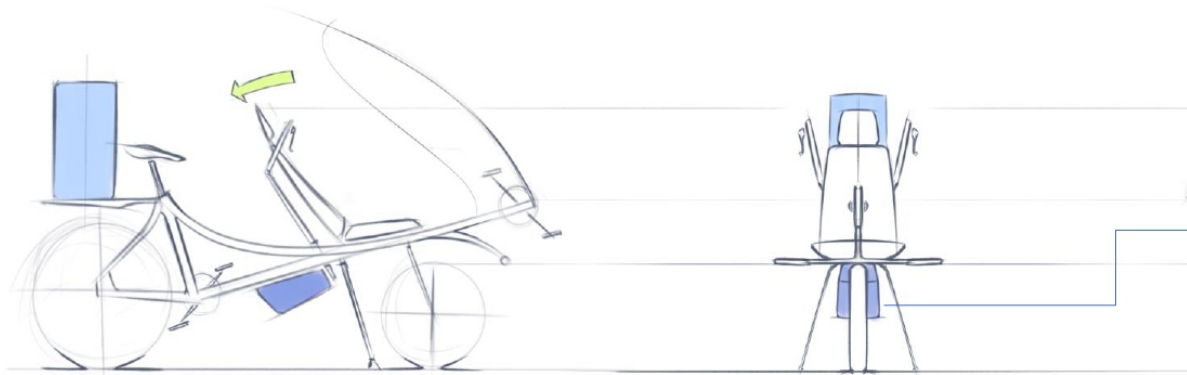

### 2-wheeler tandem semi-recumbent

#### Key Elements

Smaller in size this package features a 2-wheeler semi-recumbent feature assisted by electric motors

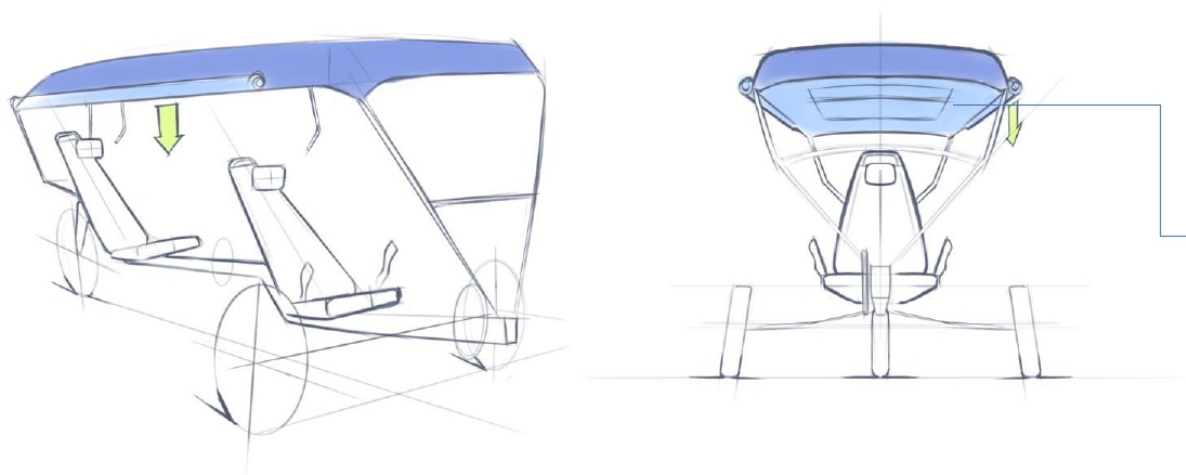

### 3-wheeler tandem recumbent

#### Key Elements

Roof mounted instruments and roll up isolators that help prevent direct contact with the environment

# Package 1 : Exploration

## Equipment Dynamics and Mechanisms

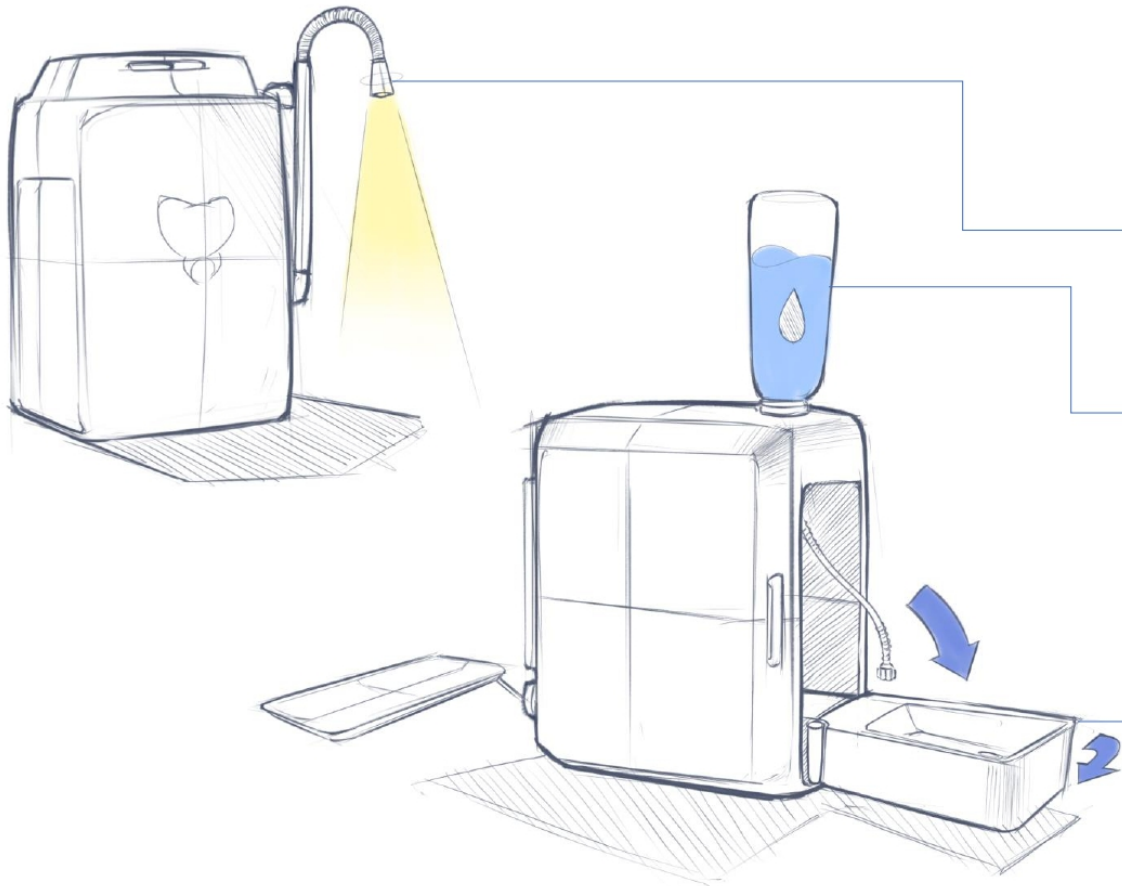

### Portable multi-purpose equipment

#### Key Element # 01

Self contained battery pack with led spot lamp for dental procedures

#### Key Elements # 02

Portable and refillable water packs for areas with water shortage assisted by battery powered pumps

#### Key Elements # 03

Adjustable pop-out cuspidor with adjustable water hose

Adjustable tool tray support

# Package 1 : Final Exploration

## 3-Wheeler Semi-Recumbent Tandem Vehicle

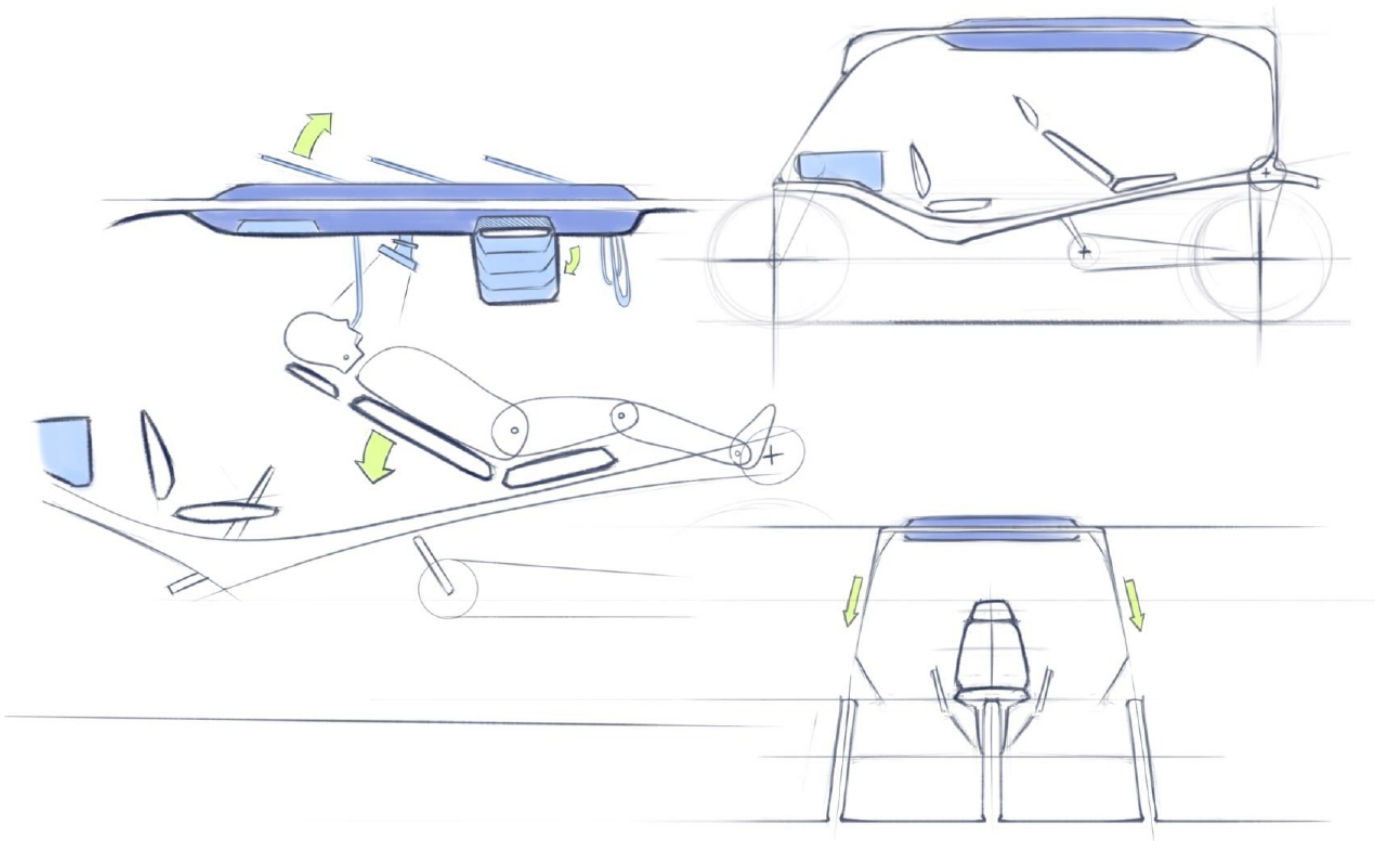

### Key Elements # 01

Roof mounted structure with overhead bins containing tools, powered equipment



### Key Elements # 02

Multi-purpose structure with drop down trays, lights, low powered suction pumps, powered by solar charged battery packs



### Key Elements # 03

Seating positioned to assist the practitioner in performing treatments on the patients

# Package 1 : Ergonomic Considerations

ANTHROPOMETRIC DIMENSIONS	MEAN DATA - MALE
Mid Patella	467mm
Arm from shoulder	704mm
Buttock Extension	556mm
Eye	821mm
Popliteal	426mm
Buttock to knee	556mm

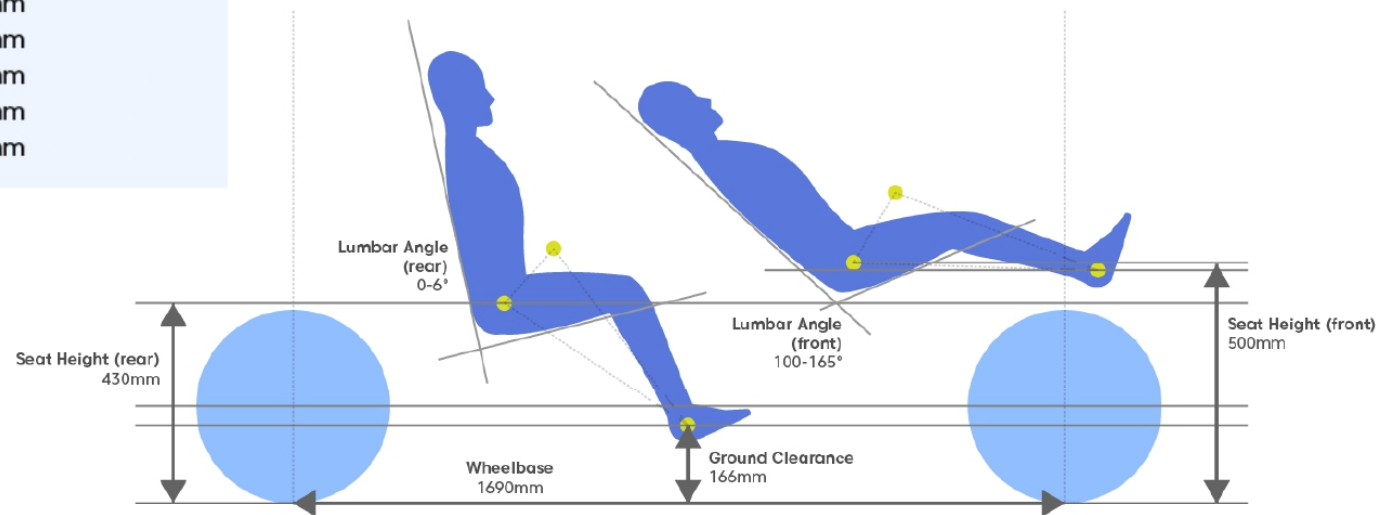

**Ergonomic considerations of Package 1** The package assists the practitioner in reducing physiological stresses as the front recumbent seat moves further backwards while the dentist can easily procure the tools and instruments from overhead bins.

## Package 1 : Cost Analysis

Components	Estimated Cost
Frame	15,000 INR
Wheels	4000 INR
Seats	12,000 INR
Roof mounted equipment	25,000 INR
Vehicle perimeter cover	6000 INR
Drivetrain	12,000 INR
Electric ride assists (750W)	10,000 INR
Miscellaneous	5000 INR
<b>Total Cost</b>	<b>89,000 INR</b>

### Cost analysis for the package compared to current solutions

The estimated cost of the package for various components including the structure, equipment and assists based on average prices for medium to high quality components.

The estimated cost of a current mobile dental healthcare clinic ranges from 15,00,000 – 40,00,000 INR.

The estimated cost of our packages will range from 85,000 to 1,00,000 INR.

## Package 2 : Exploration

### Compact 3-Wheeler Modular Clinic

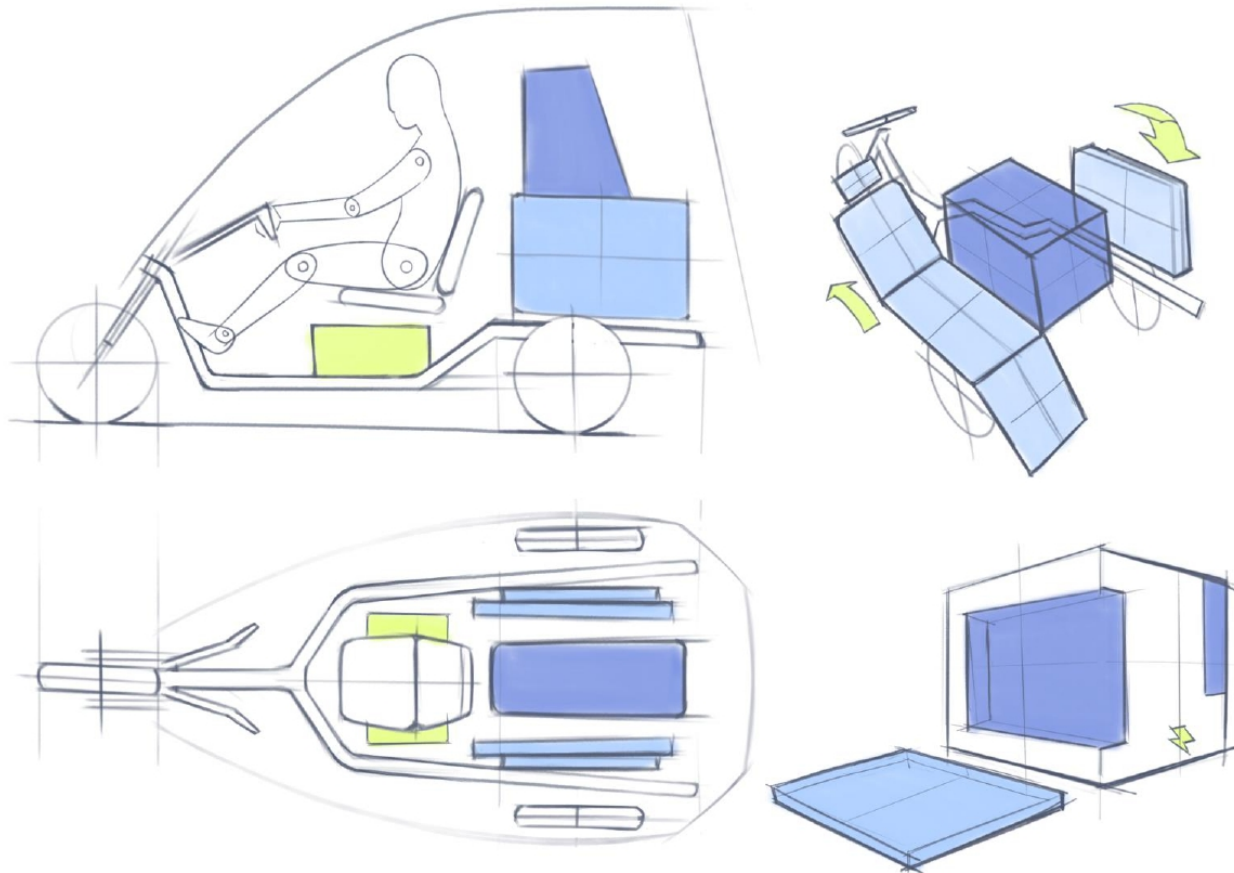

#### Ultra compact modular clinic

##### Foldable Dental Chairs

The dental chair can be folded for an ultra compact vehicle that can be taken to the narrow streets of rural areas while being lightweight

##### Dental equipment as a single unit

Including suction pumps, tools, trays and sterilizers

##### Covered vehicle with mid engine

Mid or front wheel engine mount with provide with equal weight distribution

## Package 2 : Exploration

### Compact 3-Wheeler Modular Clinic

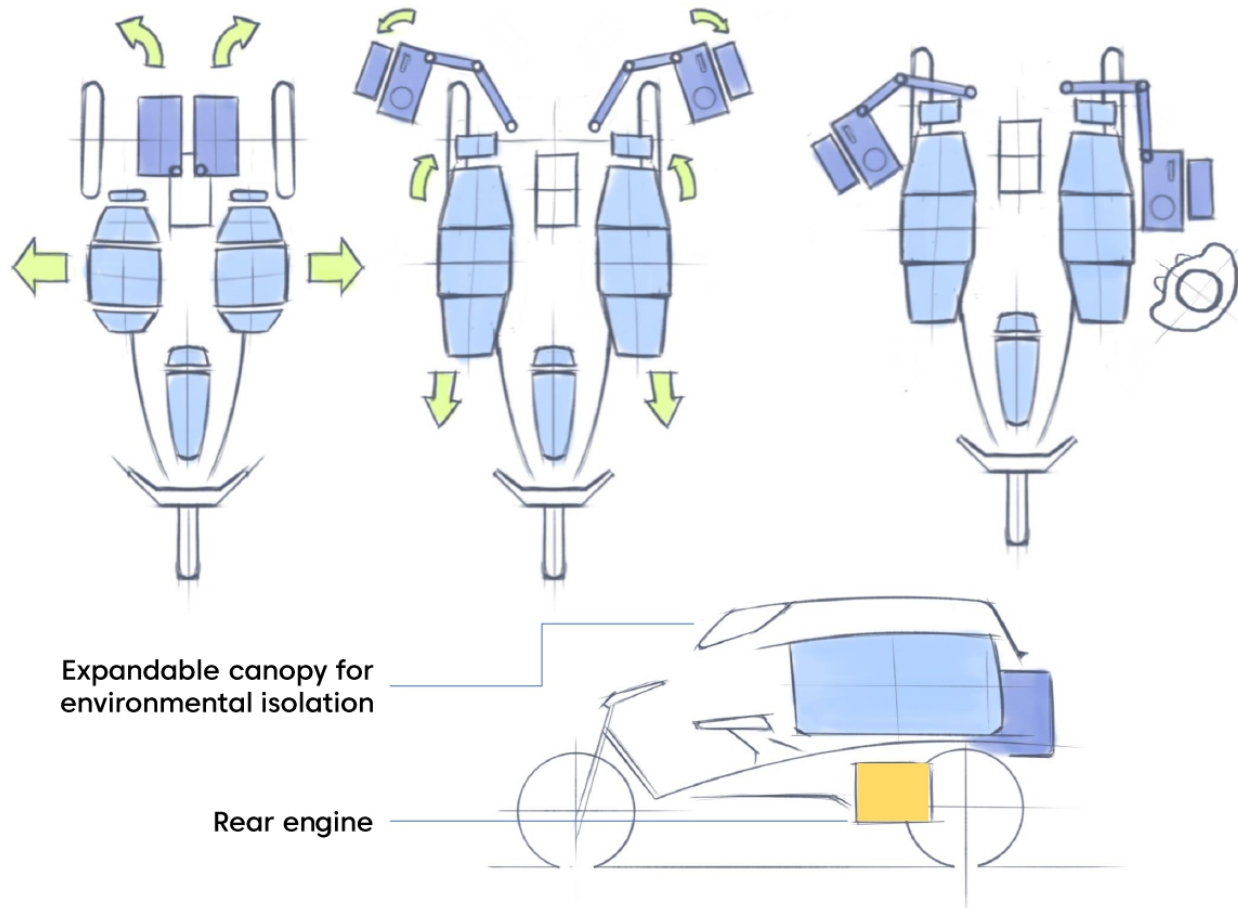

### 3-Wheeler Modular Clinic

#### Dental chair + Passenger Seat

Slide out dental chairs also act as passenger seats in straight sitting position

#### Modular adjustable equipment

Dental care packs with adjustable arms sit at the back of the vehicle

#### Canopy for environmental isolation

Canopy that can be extracted and used to cover the vehicle to isolate the patient and the dental professional from the environment

## Package 2 : Final Exploration

### Compact 3-Wheeler Modular Clinic

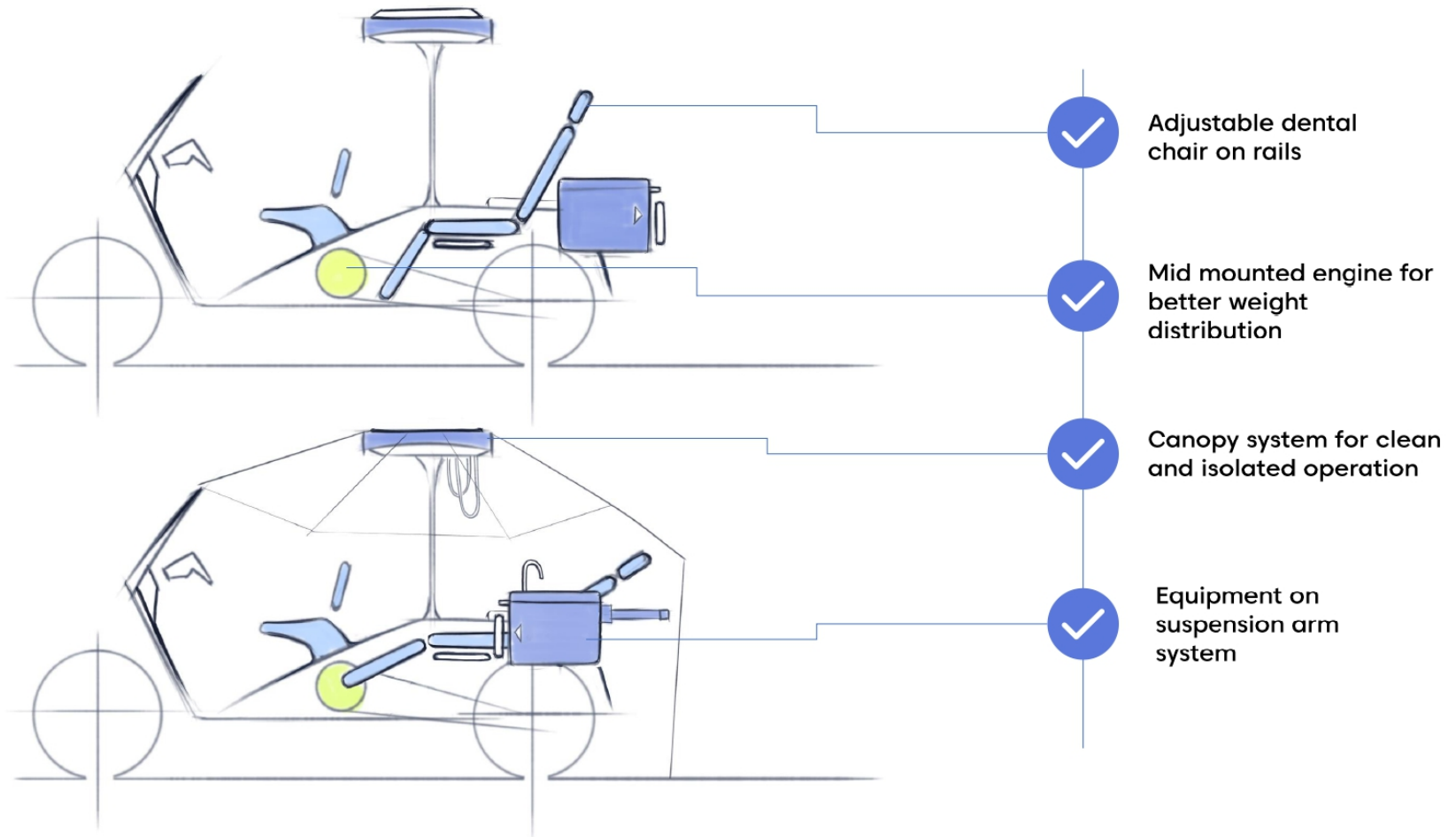



## Package 2 : Final Exploration

### Compact 3-Wheeler Modular Clinic

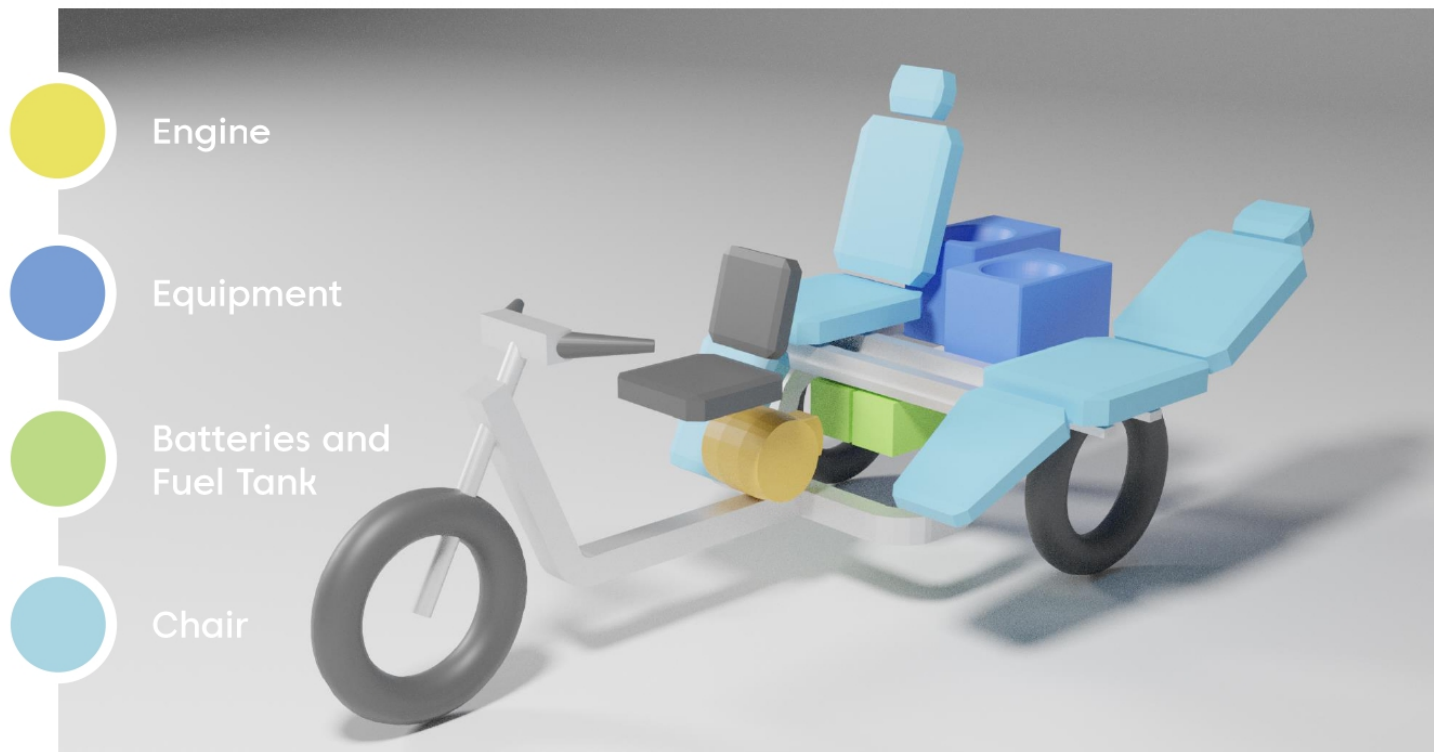

Engine



Equipment



Batteries and  
Fuel Tank



Chair



Adjustable dental  
chair on rails



Mid mounted engine for  
better weight  
distribution



Battery system for tools  
and suction pumps



Equipment on  
suspension arm system  
and guided rails

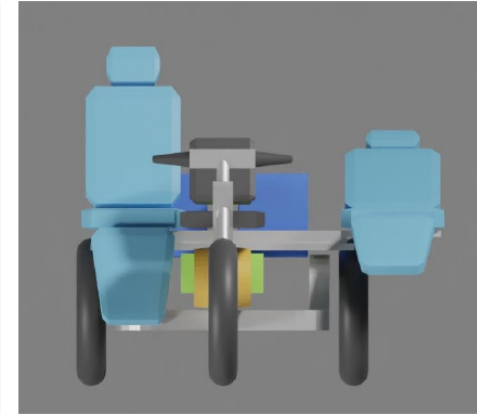
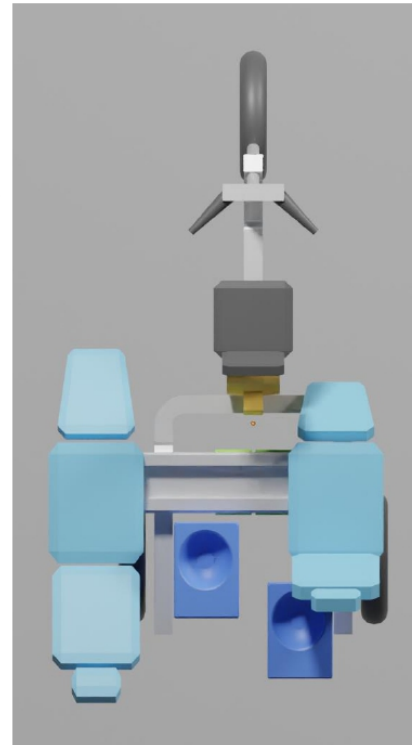
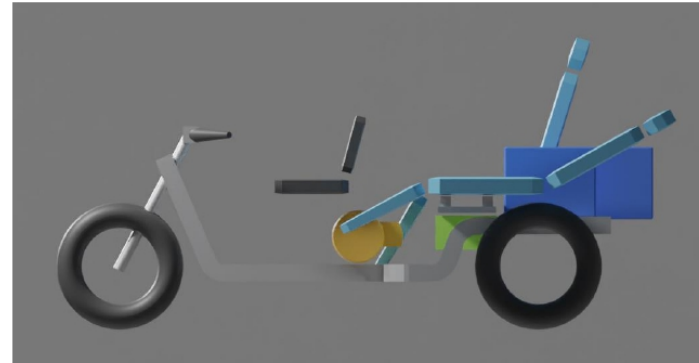
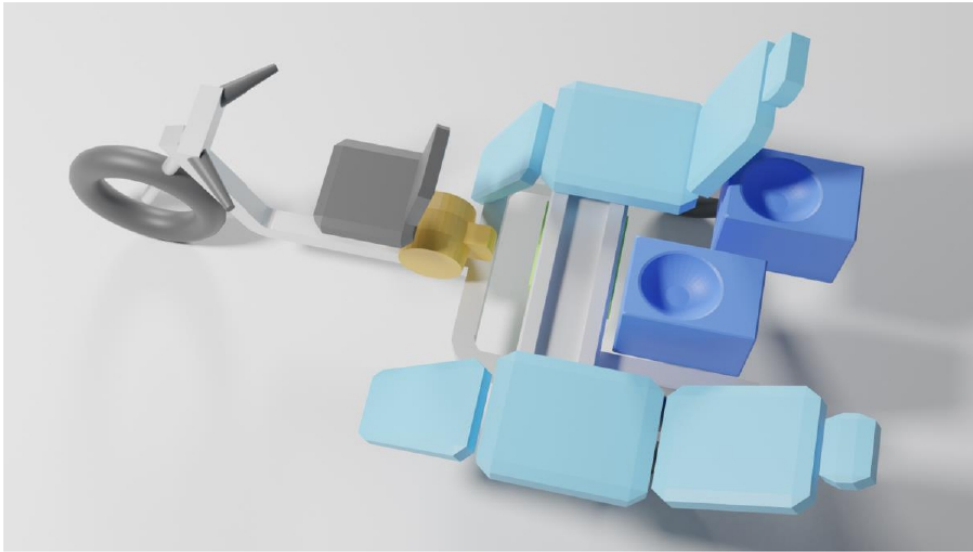

Layout and positioning of the major components of the package in 3D space

## Package 2 : Ergonomic Considerations

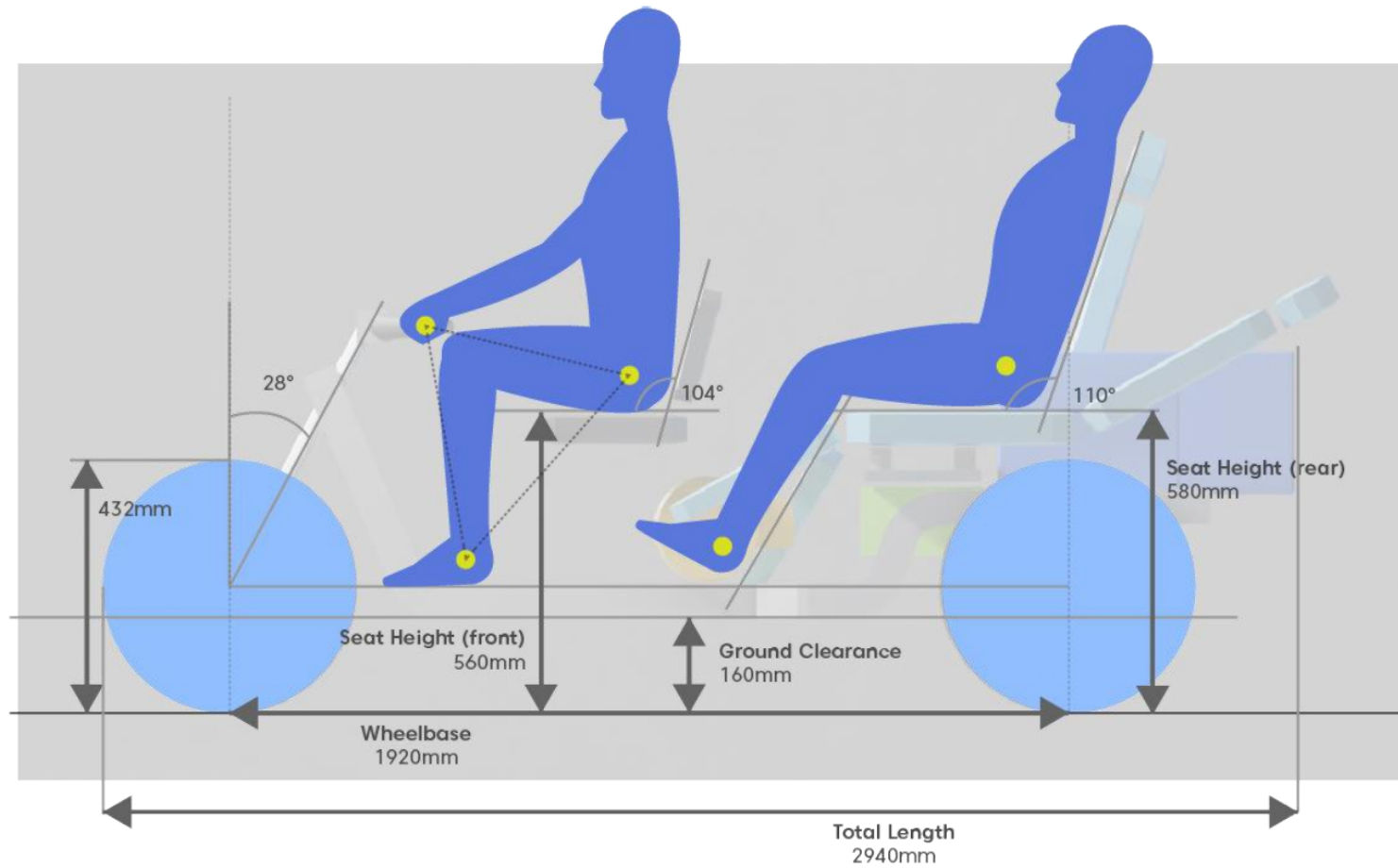

## Package 2 : Cost Analysis

Components	Estimated Cost
Frame	20,000 INR
Wheels	6000 INR
Seats	15,000 INR
Batteries	10,000 INR
Vehicle canopy system	6000 INR
Diesel Engine	50,000 INR
Modular equipment box	20,000 INR
Miscellaneous	10,000 INR
<b>Total Cost</b>	<b>1,37,000 INR</b>

### Cost analysis for the package compared to current solutions

The estimated cost of the package for various components including the structure, equipment and assists based on average prices for medium to high quality components.

The estimated cost of a current mobile dental healthcare clinic ranges from 15,00,000 – 40,00,000 INR.

The estimated cost of our packages will range from 1,25,000-1,50,000 INR.

# Package 3 : Exploration

## 2-Wheeler Assisted Carriages

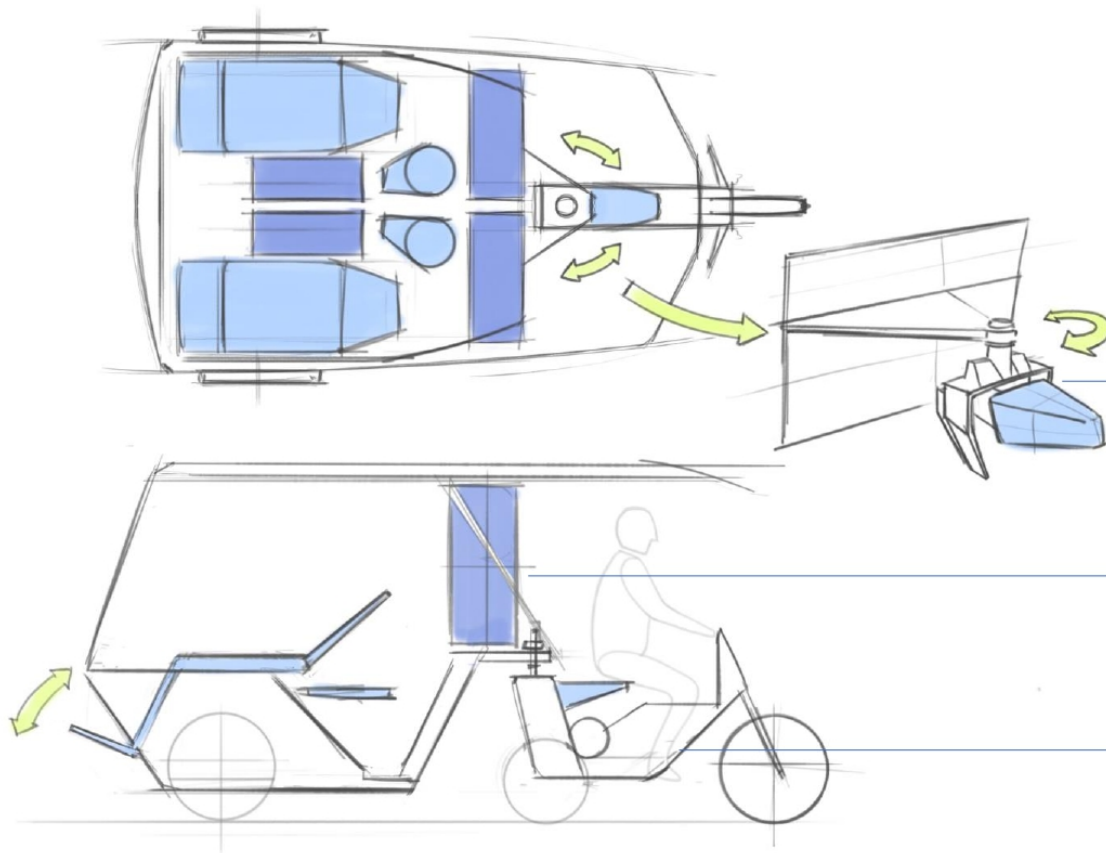

### 2-Wheeler Assisted Carriages

#### Hinge System

A hinge system that can be mounted on existing two wheelers or a purpose-built two-wheeler vehicle to save cost

#### Larger equipment

The equipment is mounted as part of the carriage structure while providing additional storage

#### Purpose built 2-wheeler

A purpose-built two-wheeler that assists the carriage and can be removed for personal transportation

# Package 3 : Exploration

## 2-Wheeler Assisted Carriages

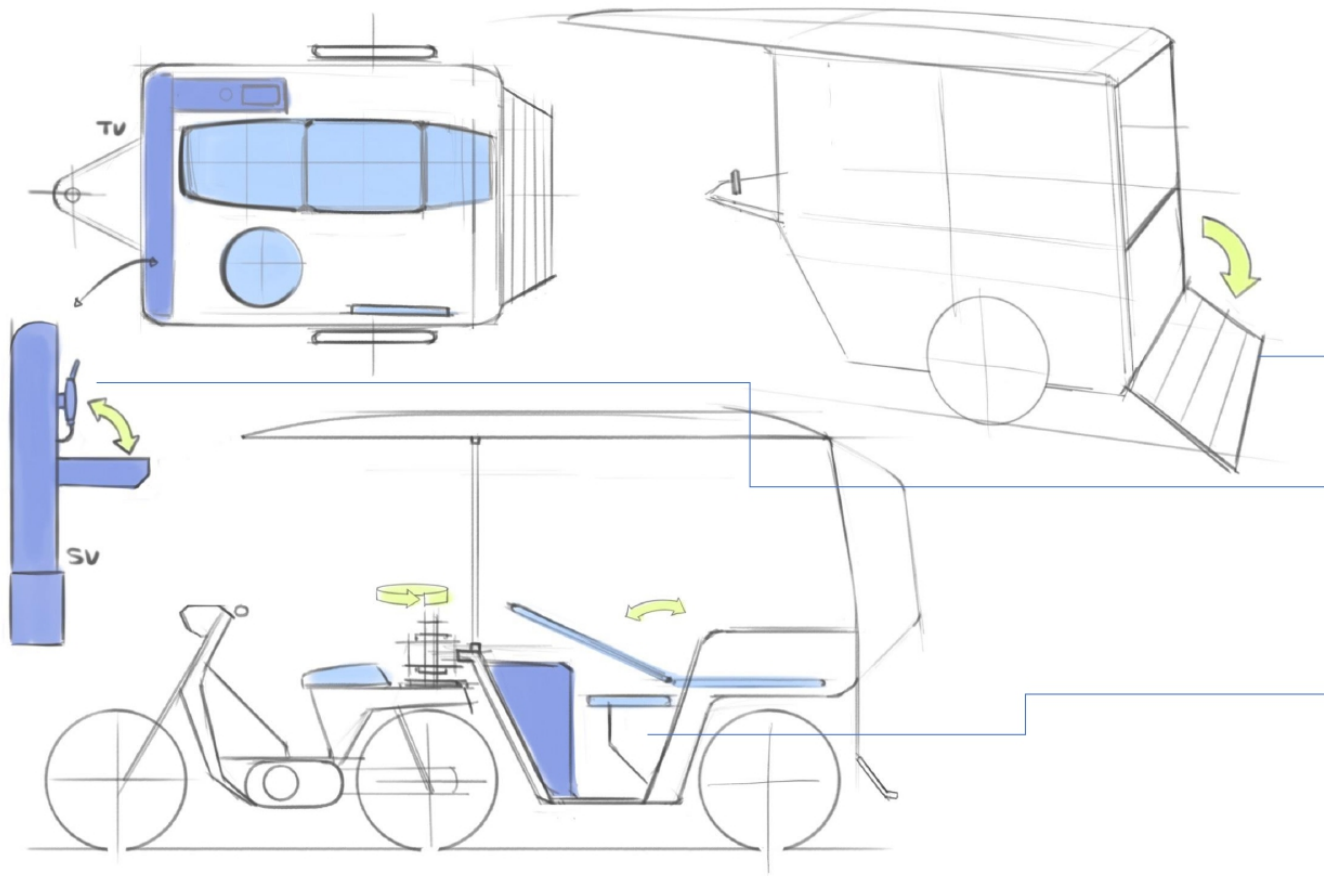

### 2-Wheeler Assisted Carriages

#### Ladder system

Due to the tall height of the vehicle the users are assisted with a foldable ladder system for easy entry and exit

#### Wall mounted equipment

Wall mounted equipment with retractable accessories

#### Inbuilt stool

Inbuilt stool for the practitioner for seating position while carrying out procedures

## Package 3 : Exploration

### 2-Wheeler Assisted Carriages

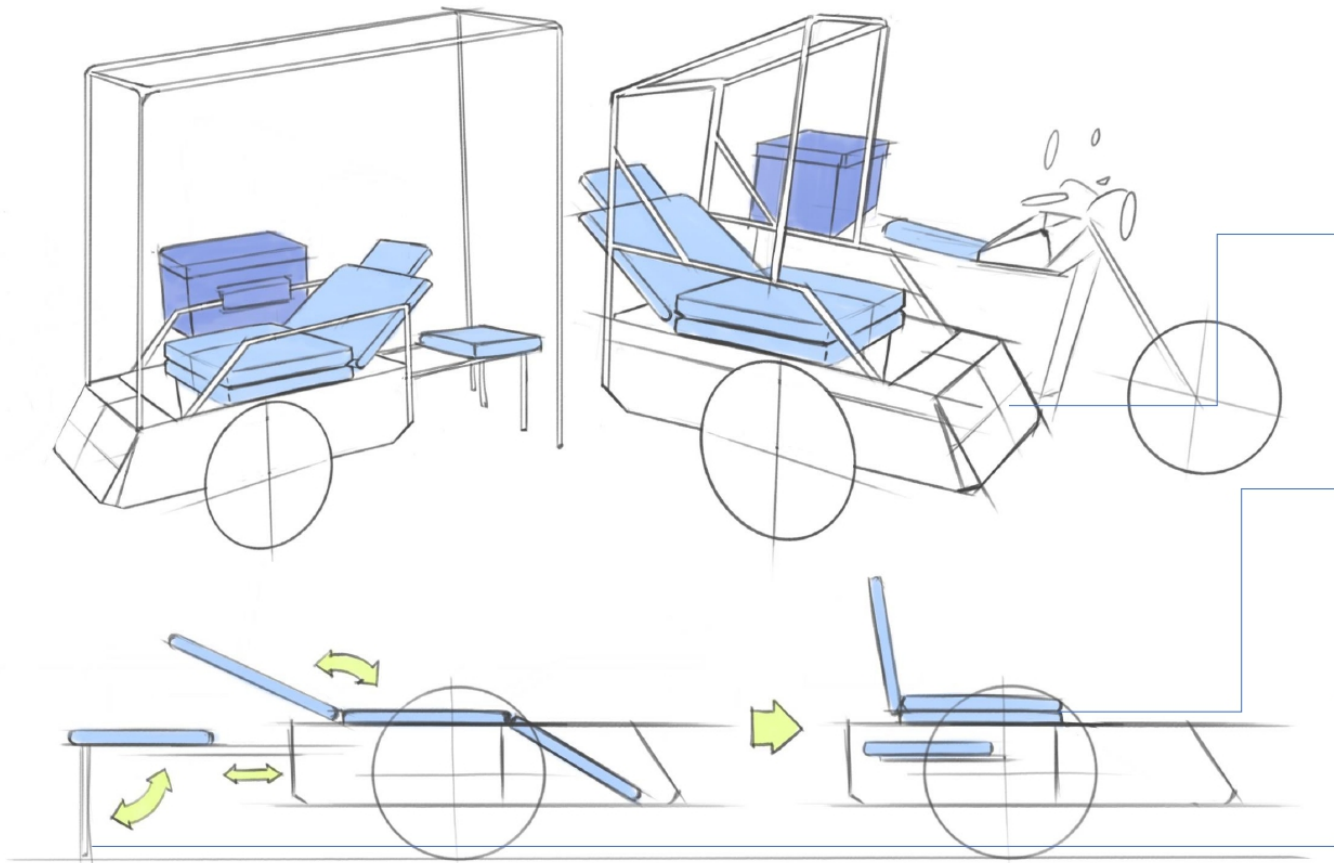

#### 2-Wheeler Assisted Carriages

##### Side-car with tubular structure

The side-car with tubular structure can be altered based on purpose, a 2-wheeler mounted equipment box can also be fitted for carrying out dental procedures

##### Folded seat

Folded seat for better cushioning that can be retracted to provide support for legs during static position

##### Slide out dental stool

A retractable stool mounted underneath the dental chair in the hollow space can be pulled out, it can be supported by foldable legs

## Package 4 : Exploration

### 3-Wheeler Integrated Dental Clinic

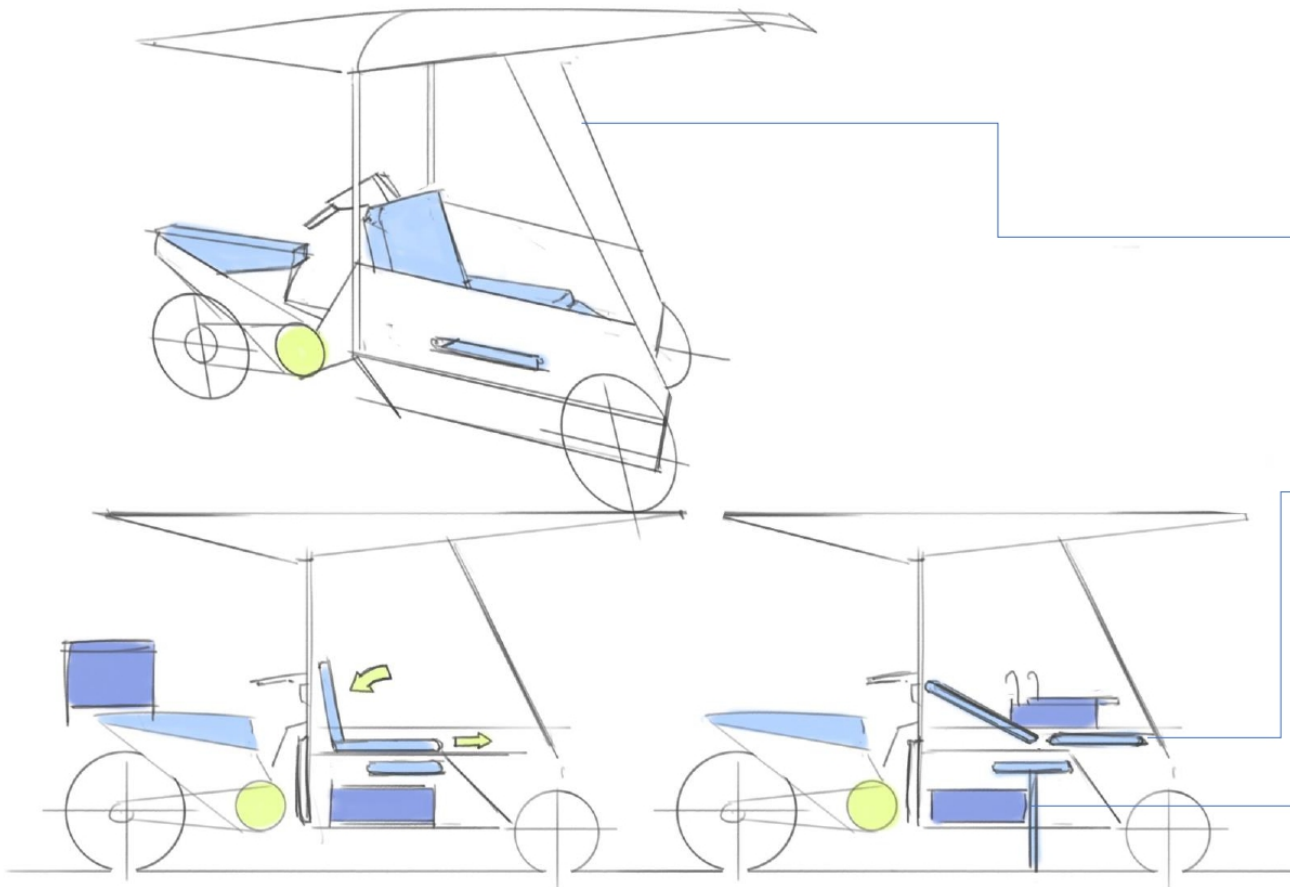

### 3-Wheeler Integrated Dental Clinic

#### Front mounted car

A front mounted car is integrated with a 2-wheeler additionally provided with a canopy

#### Sliding chair

To recline, the chair slides outwards saving space in terms of length of the vehicle

#### Additional dental stool, equipment and machines

Additional dental equipment and machines are mounted underneath the vehicle and can be retracted when needed



## Package 4 : Exploration

### 3-Wheeler Integrated Dental Clinic

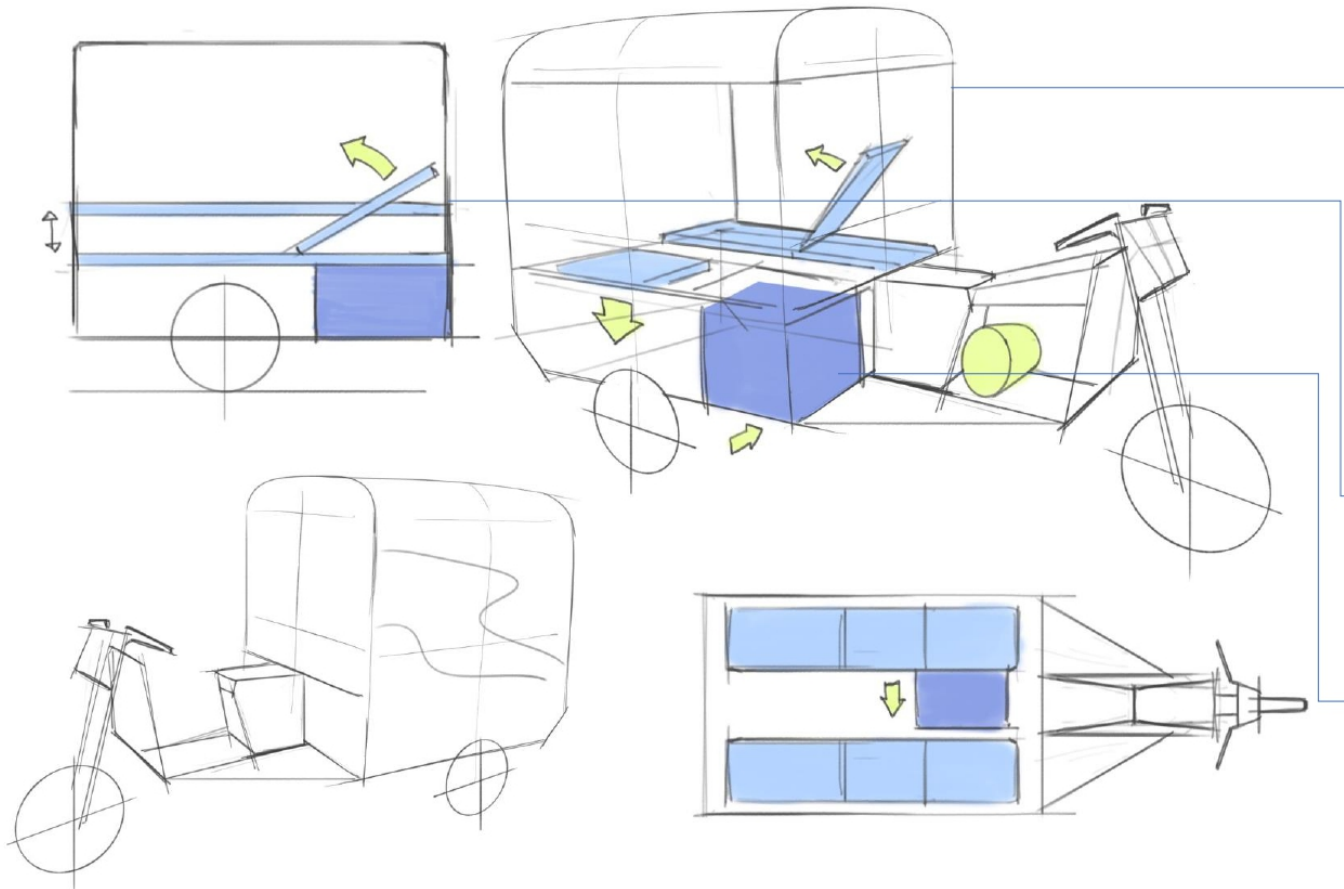

### 3-Wheeler Integrated Dental Clinic

#### ✓ Closed shell

The main clinic is in a covered structure providing additional privacy and isolation from the surroundings

#### ✓ Seats at different levels

To reduce moving parts the opposite benches are situated at different elevation for a more ergonomic posture while carrying out the dental procedure

#### ✓ Large equipment

This solution can carry a large amount of equipment that is situated underneath the bench-like seats

# Final Package : Frame Ideation

## 3-Wheeler Extended Frame

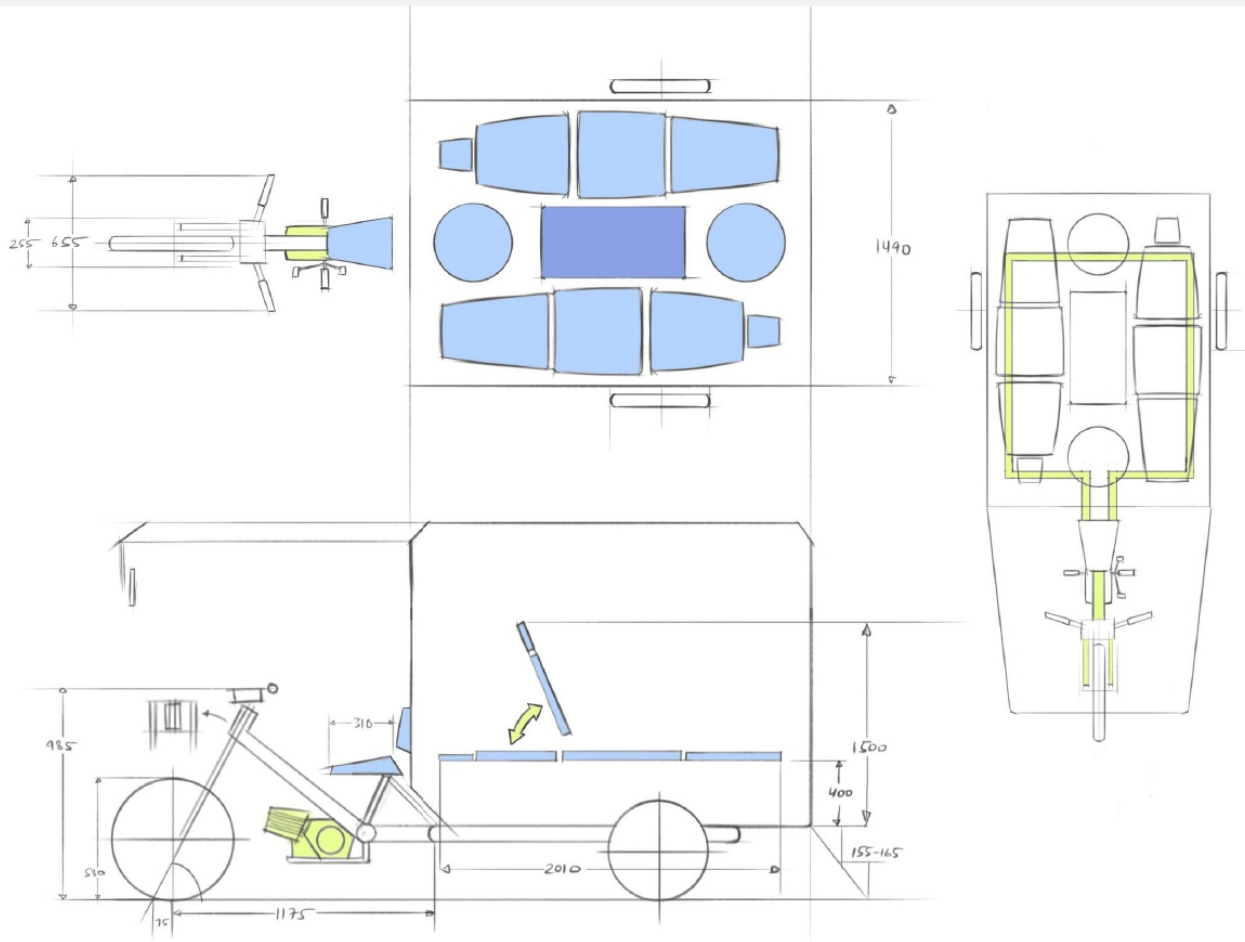

Minimal and economical tubular frame supports the entire structure



Lower driver seating position with engine in the front for better weight distribution and an overall low center of gravity to prevent tipping



Larger front wheel provides better maneuverability while the smaller rear wheels allow the vehicle and dental chairs to be low



The rear space allows for various setups and arrangements so the vehicle can be flexible in terms of dental treatments that it can provide

# Final Package : 3D Exploration of Frame and Major Components

## 3-Wheeler Extended Frame

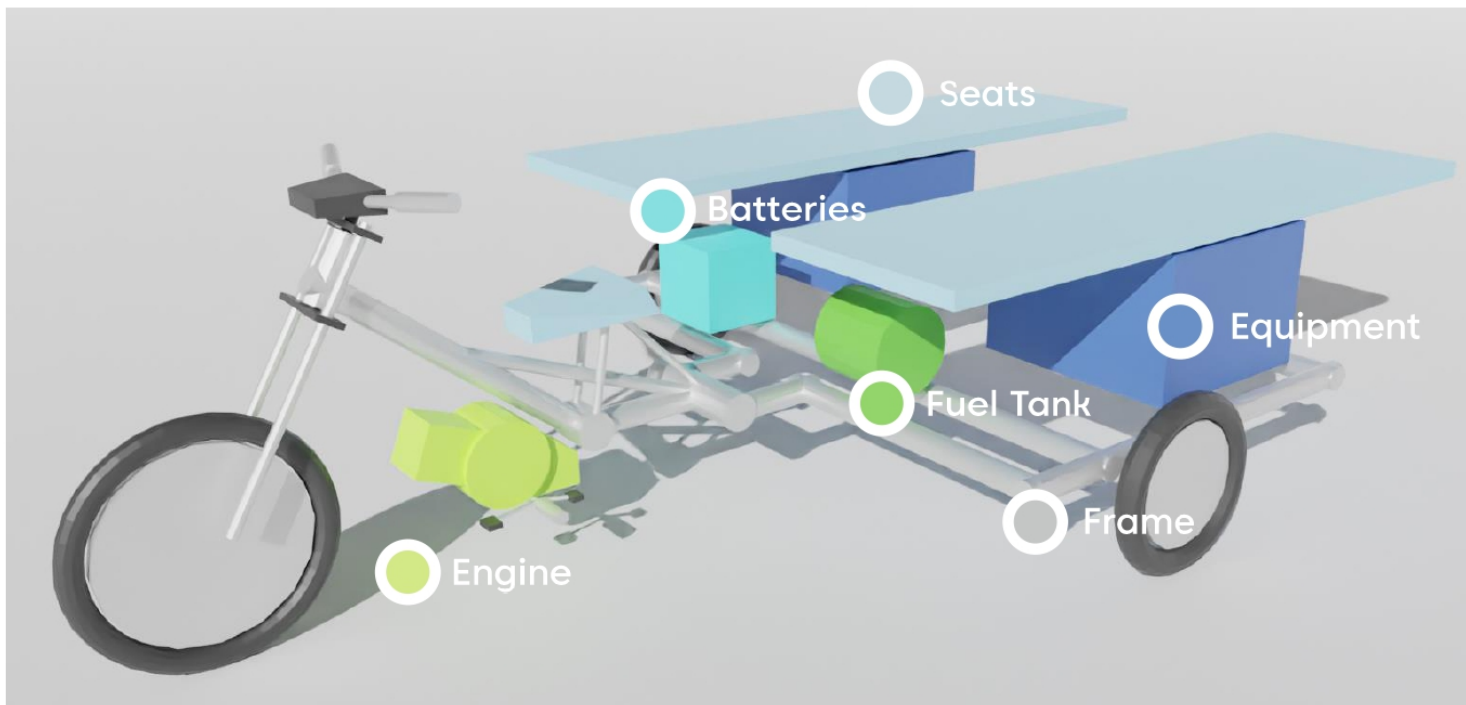

Minimal tubular frame supports the entire structure



The vehicle has a high ground clearance to deal with the uneven terrains



The space in the rear allows for various setups and configurations



Package consists of a 10L fuel tank along with two 12V – 26AH batteries

# Final Package : Dimensions and Views

The dimensions of the package along with various views

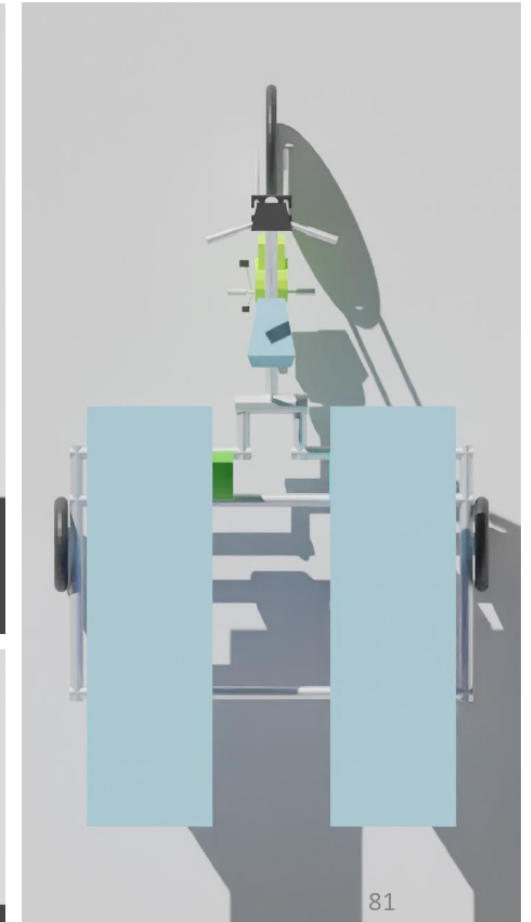
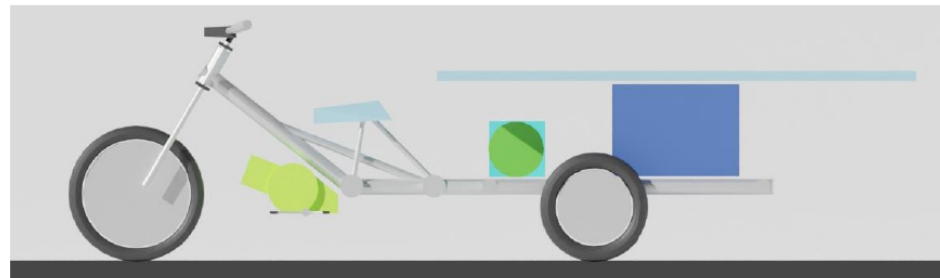
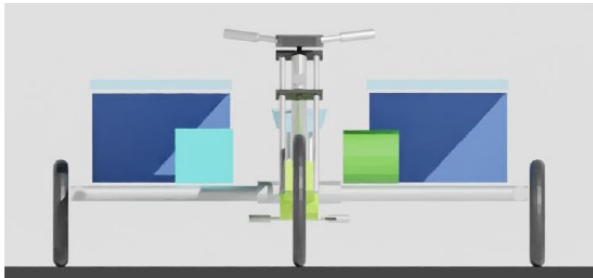
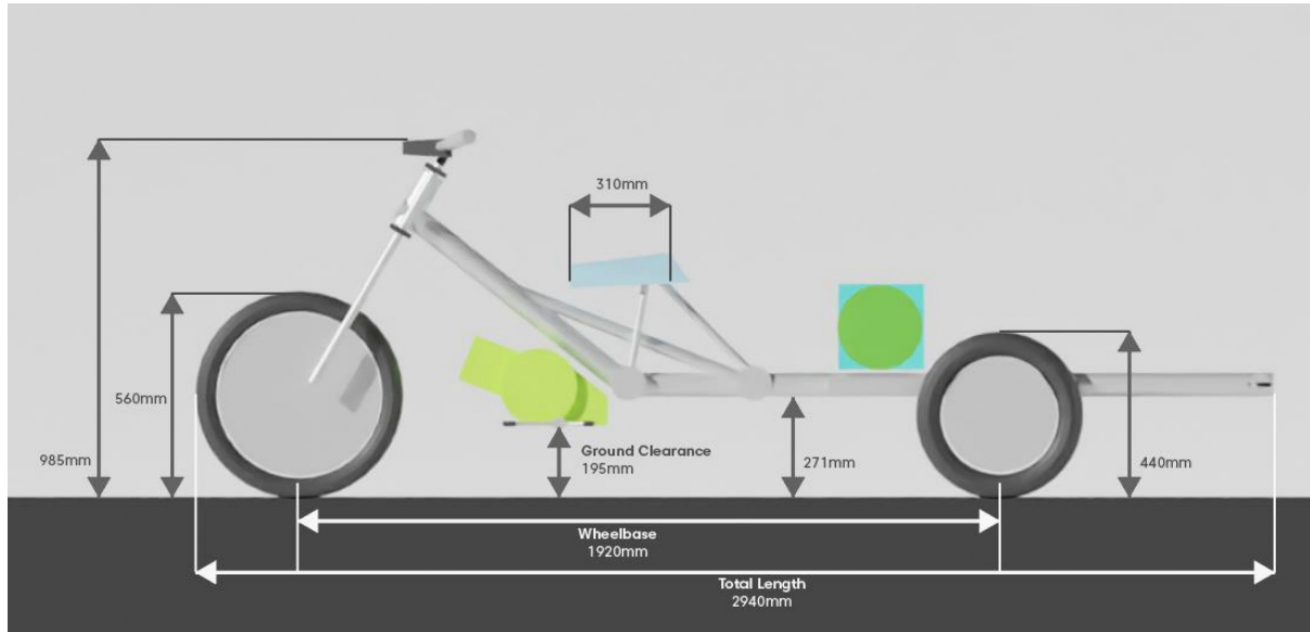

# Final Package : Seating Ideations

## 3-Wheeler Extended Frame

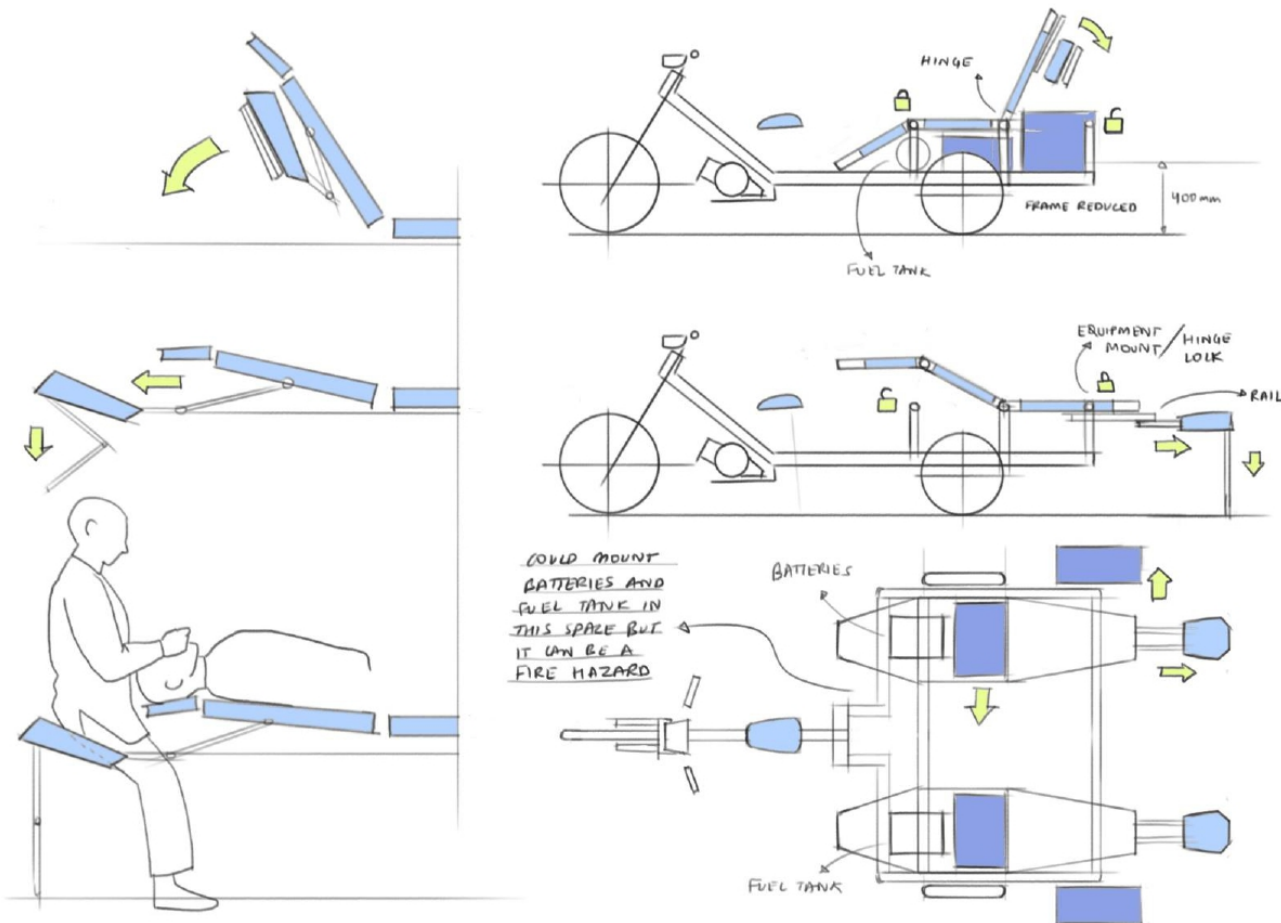

A hinge system for the dental chair is implemented with 2 locking positions



The dental stool is mounted behind the dental chair that slides out with the help of telescopic channels



There are additional racks mounted underneath the dental chairs providing storage space that can slide out



In the stationary position of the vehicle the dentist can have an upright sitting posture with slight inclination for a more ergonomic posture

# Final Package : 3D Exploration

## 3-Wheeler Extended Frame

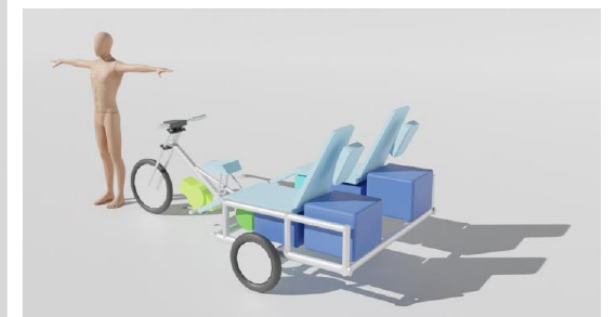
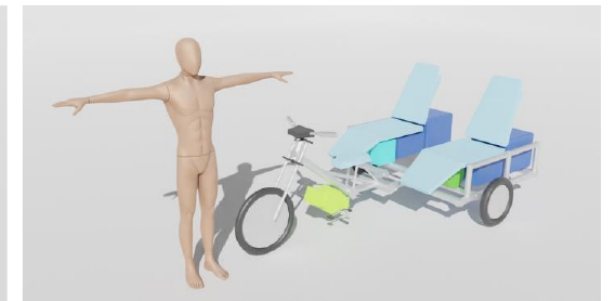
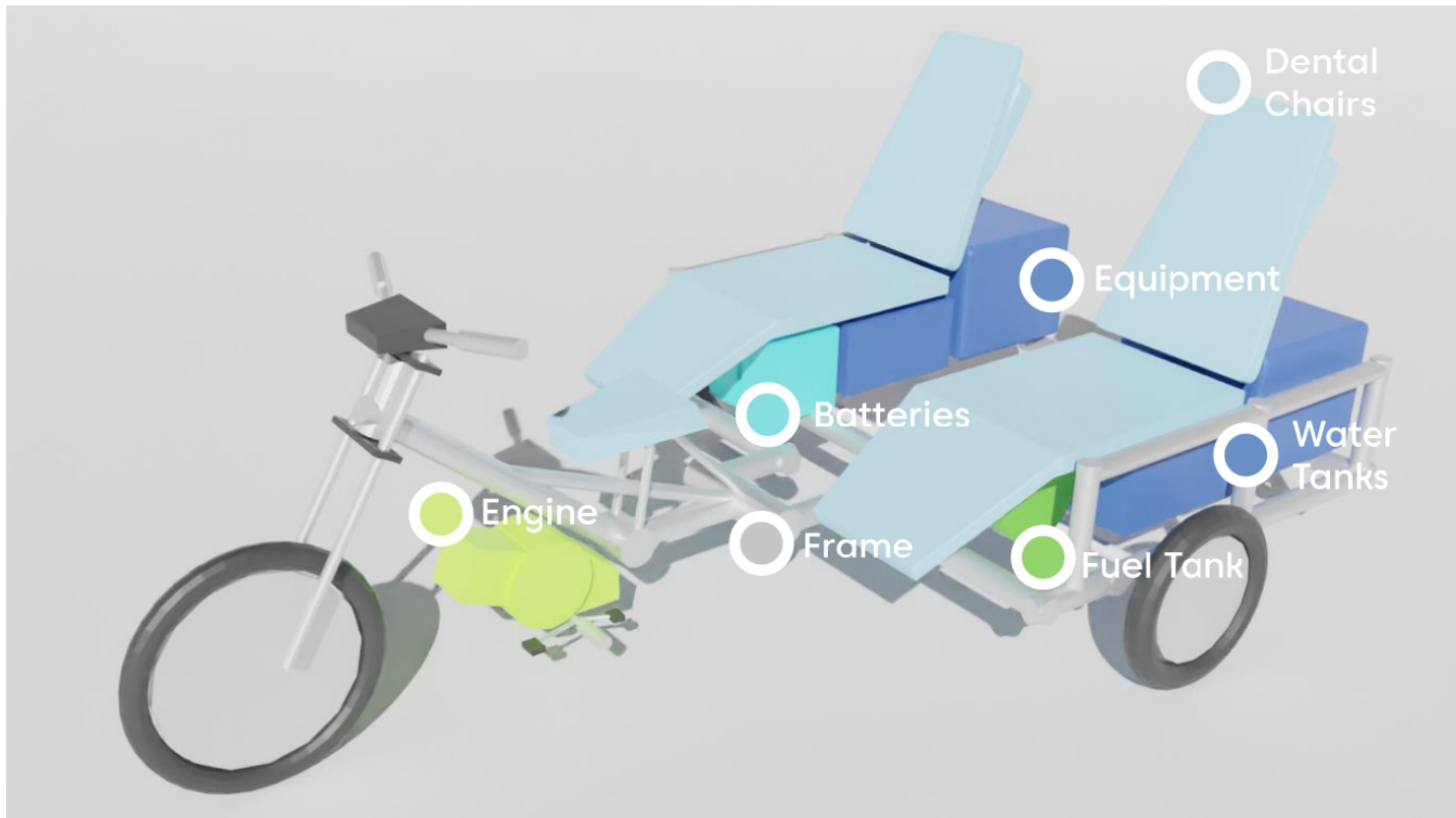

Different views and placements of the major components of the package

# Final Package : 3D Exploration

## 3-Wheeler Extended Frame

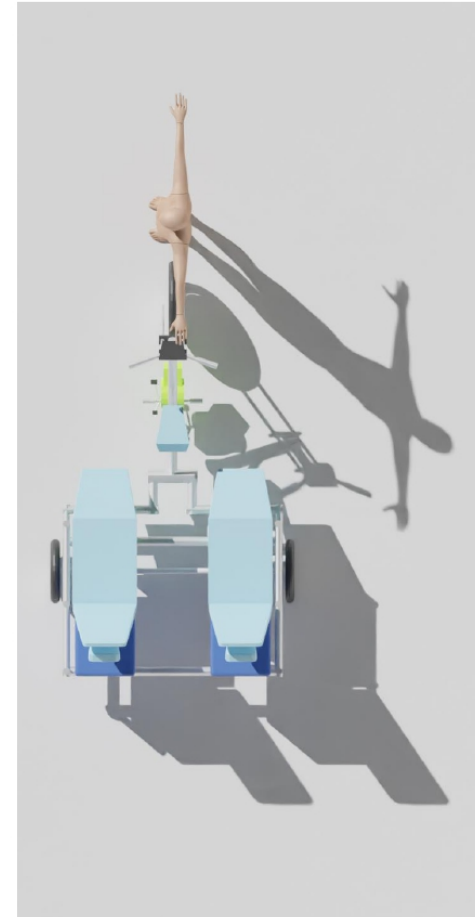

Different views and placements of the major components of the package

# Final Package : 3D Exploration

## 3-Wheeler Extended Frame

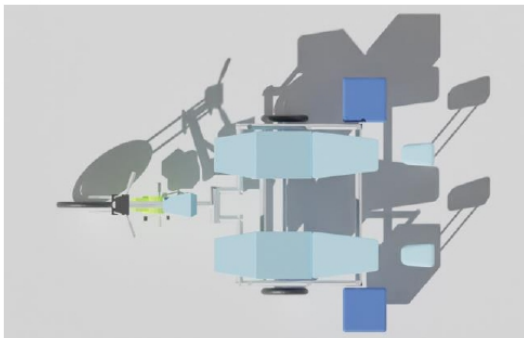
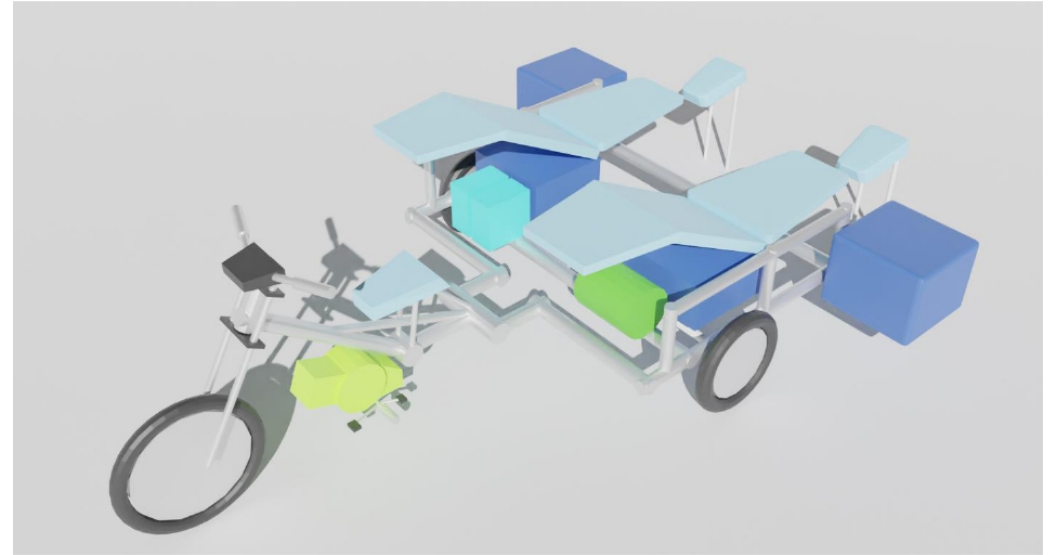
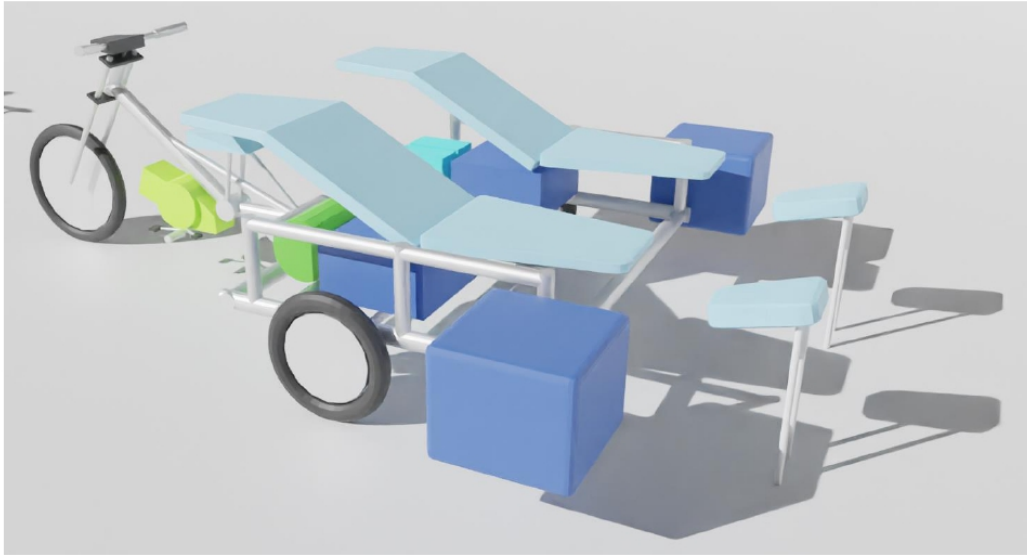

Different views of the package in the inclined (operational) position



# Final Package : Dimensions and Ergonomic Considerations

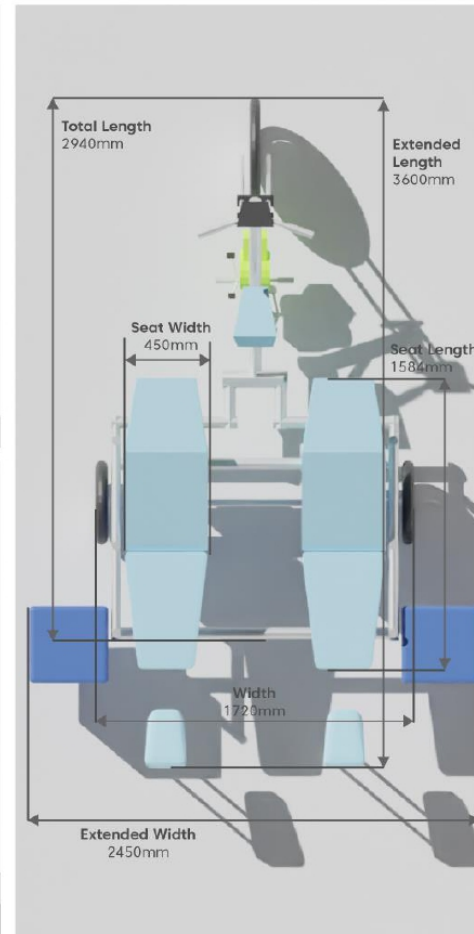
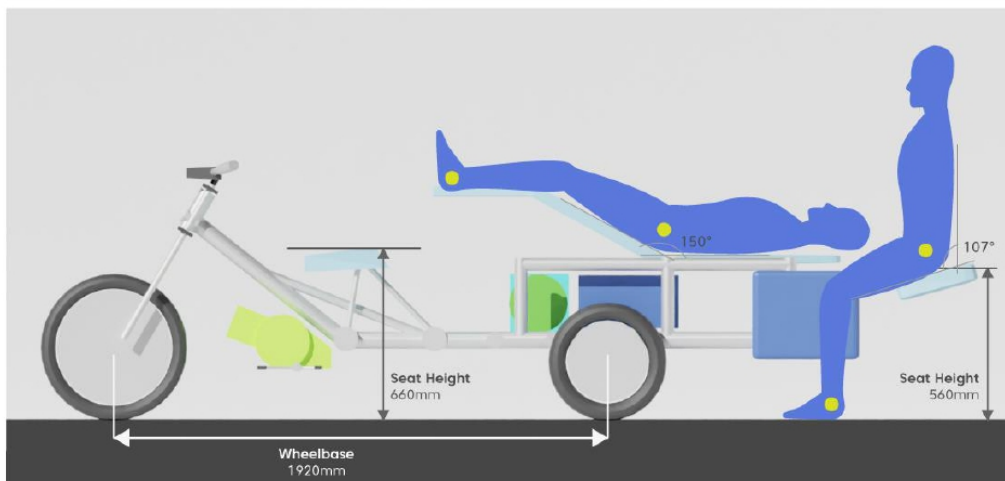
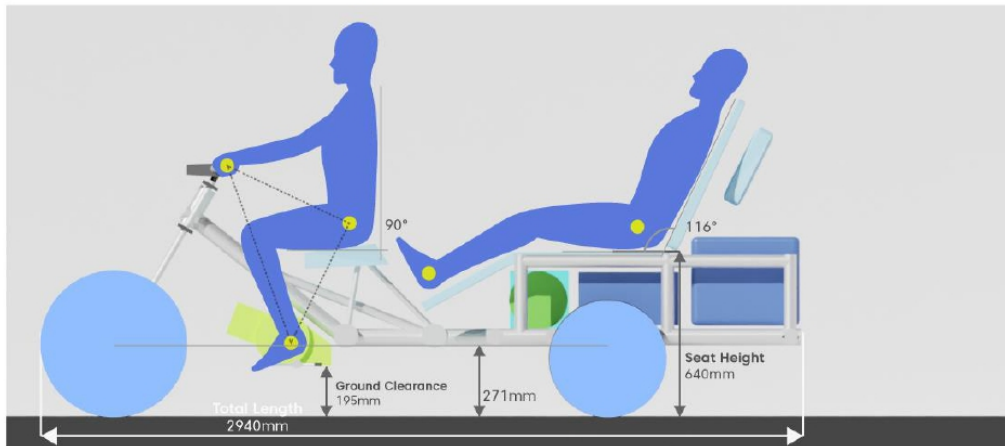

## ANTHROPOMETRIC DIMENSIONS MEAN DATA - MALE

Mid Patella	467mm
Arm from shoulder	704mm
Buttock Extension	556mm
Eye	821mm
Popliteal	426mm
Buttock to knee	556mm

## Final Package : Cost Analysis

Components	Average Cost
Frame	10,000 INR
Wheels	6000 INR
Seats	10,000 INR
Batteries	5000 INR
Vehicle canopy	5000 INR
Engine	20,000 INR
Equipment	20,000 INR
Miscellaneous	10,000 INR
<b>Total Cost</b>	<b>81,000 INR</b>

### Cost analysis for the package compared to current solutions

The estimated cost of the package for various components including the structure, equipment and assists based on average prices for medium to high quality components.

The estimated cost of a current mobile dental healthcare clinic ranges from 15,00,000 – 40,00,000 INR.

The estimated cost of our package will range from 80,000-90,000 INR.

# Ideations

## SCAMPER

Exploring a lateral thinking technique to challenges the initial ideations and help explore new possibilities

Substitute	Combine	Adapt	Modify	Put to another use	Eliminate	Reverse
<p>Small dental healthcare clinics located in various villages.</p> <p>Makeshift dental camps that can be established at a location for a long period of time and relocated after a certain period.</p>	<p>The 3-wheeler solution can be part of a fleet of vehicle with varying degree of services provided.</p> <p>Specially designed Backpack kits alongside the vehicle will help carry more portable equipment</p>	<p>The mobile dental clinic can work as an emergency for primary medical assistance and ambulance service.</p> <p>The vehicle can help provide various other treatments in areas with lack of basic healthcare facilities along with first aid.</p>	<p>The vehicle can be enlarged with a larger powertrain and additional dental chairs in tandem.</p> <p>A trailer with larger equipment providing even more functionality to the clinic can be added.</p>	<p>The vehicle could provide means of transportation for the people with physical ailments for long journeys as the seats can be adjusted to recline 150°.</p> <p>With flat beds instead of the chair the vehicle can be used to transport large goods.</p>	<p>The solution could have the dental equipment unit removed and simply act as portable dental chairs reducing the cost and vice versa.</p> <p>The three-wheeler vehicle can be simplified into a two-wheeler vehicle with sidecars.</p>	<p>The solution can be rearranged to provide an isolated environment for treatments that can be carried out for long durations. The vehicle turns into a makeshift camp.</p>

# Rationale

## Justification for the final package

<b>Powertrain</b>	A gasoline-powered engine is chosen due to the unreliable electric supply in the rural areas. Dental professionals deal with physiological stress, the weight of the vehicle with the required equipment is harder to control with a human powered solution. A petrol engine provides an economical and eco-friendlier solution as compared to a diesel engine.
<b>Chassis</b>	A basic tubular frame provides the structural strength required for the vehicle while being cost effective and easy to manufacture.
<b>Single modular equipment kits</b>	A single kit that contains dental light, cuspidor, tool tray, suction pump saves space and keeps the cost low. The kit can be assisted with battery packs that can be charged after a day's operation.
<b>Appropriate Adoption for Rural India</b>	A simple, easy to maintain and manufacture solution works well in the rural India. It is less intimidating than the ambulance like dental vans currently deployed in such areas. The frame is not purpose specific and provides room for a wide variety of uses while being highly cost effective.
<b>Wheel size</b>	While the large front wheel greatly improves stability on rough rural roads while being cost effective and light in weight, the smaller rear wheel allows more room for the equipment and helps reduce the elevation of the seats and dental chairs.
<b>Cost</b>	While being costlier compared to a human powered solution, the final package helps reduce stress and provides more space for dental procedures. The cost of the vehicle may lie between 80,000 - 90,000 which is 15 times lower than the average price of an existing solution in the market.

Design  
**Brief**

Direction of the intended  
outcome of the project

5

# Design Brief

Defining the direction of  
the project

*How might we design a vehicle that helps Dr Gurpreet to reach a larger community so she can provide a complete care for most dental issues while keeping track of the patients that mitigates her issue of poor physical health?*

**A low-cost IC engine powered 3-wheeler mobility solution that can establish itself in a certain area for multiple-short durations of time while providing adequate equipment for a wide variety of treatments.**

**The vehicle keeps the practitioner and patient isolated from one another and the surroundings.**

**The solution accommodates 2 dental healthcare personnel and 1 driver/assistive staff.**

**The platform decrease the physiological stress on the practitioners with a minimal cluster of necessary equipment.**

**A compact vehicle with expansion capabilities for greater maneuverability in the rough and narrow pathways of rural areas.**

**Aesthetic Brief The vehicle seems familiar and more open for rural settings reducing the fear related with dental treatments. Avoiding the Ambulance aesthetics of most mobile dental clinics.**

# Technical Specifications

Defining the technical specification of the project

## **PHYSICAL SPECIFICATIONS**

**Wheelbase:** 1920mm

**Total Length:** 2940mm

**Ground Clearance:** 195

**Wheel size (front):** R18

**Wheel size (rear):** R12

## **ERGONOMICS**

**Driver seat angle:** 90°

**Driver seat height:** 660mm

**Dental + Passenger seat angle:** 116°-150°

**Dental + Passenger seat height:** 640mm

**Dental stool height:** 560mm

## **POWERTRAIN**

**Engine:** 200cc Petrol Engine

**Chassis:** Tubular Frame

**Front Suspension:** Telescopic

**Rear Suspension:** Coiled over spring

Design  
**Ideations & Concept**

Appealing and suitable design  
ideas leading to the final  
outcome of the project

6



# Mood Board

ORAL HEALTHCARE VEHICLE FOR RURAL INDIA\_

Inspirations for the theme of vehicle styling

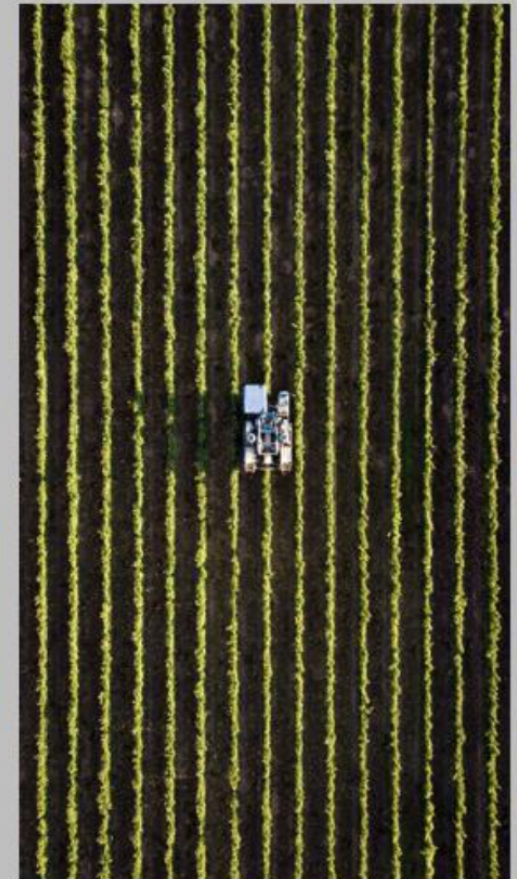
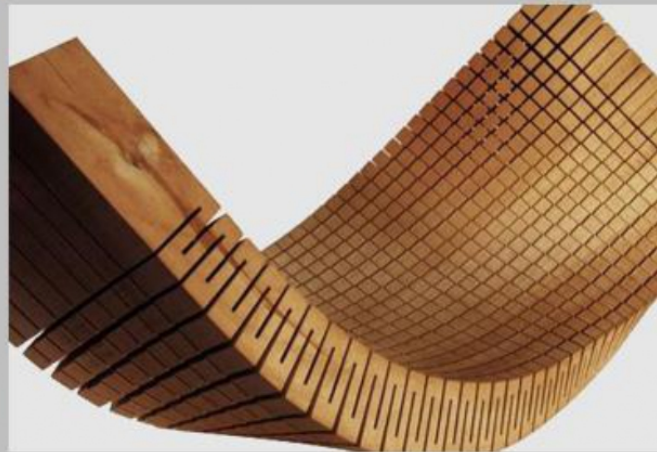
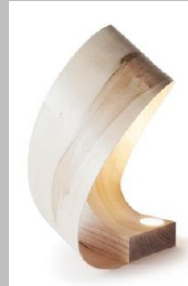

Since the vehicle expands in length during a stationary position the covering for the vehicle should be able to re-orient. A step system is also needed for ease of entry and exit from the back of the vehicle.

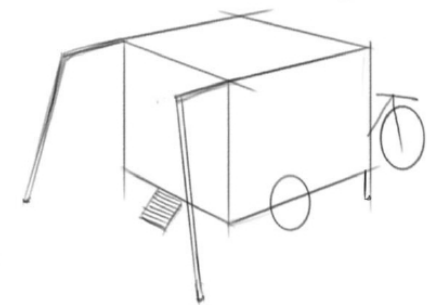
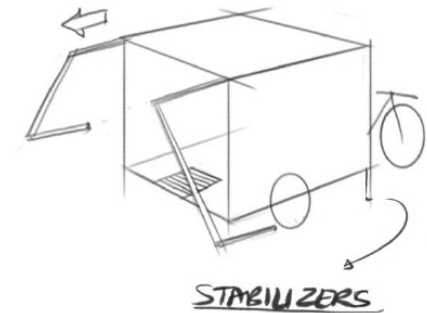
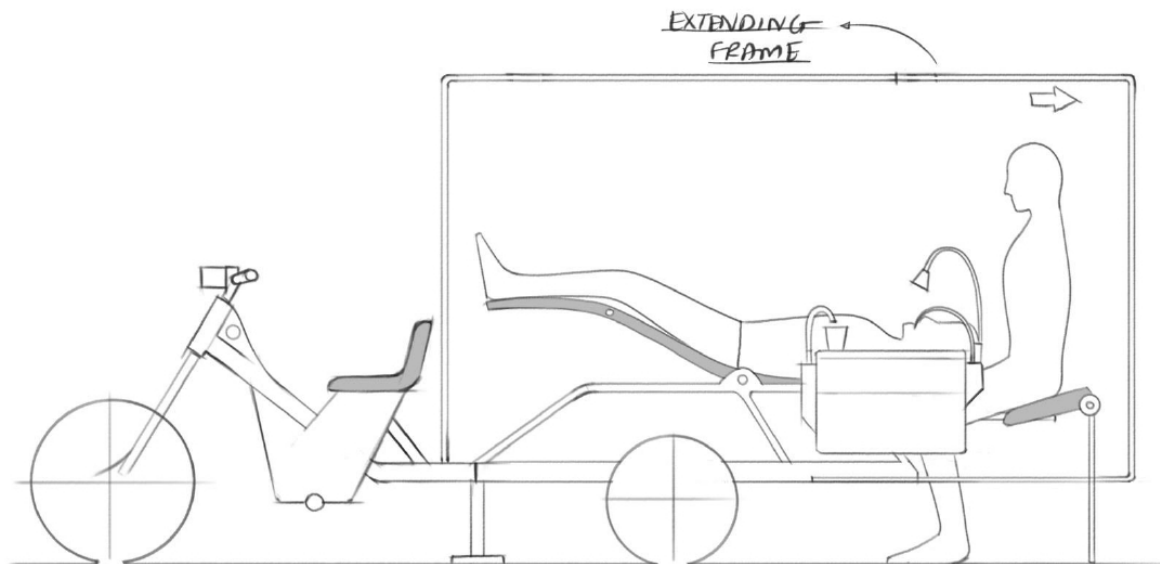
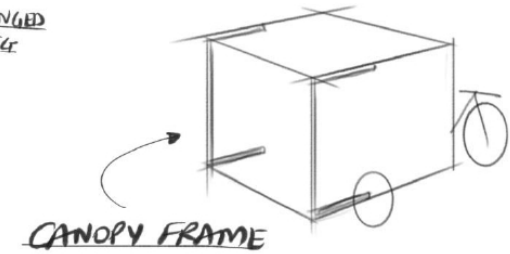
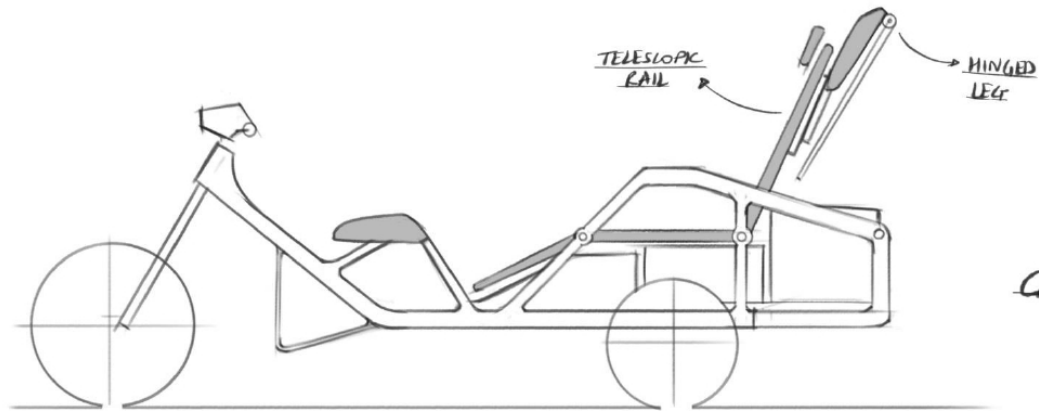

# CONCEPT IDEATIONS

# CONCEPT IDEATIONS

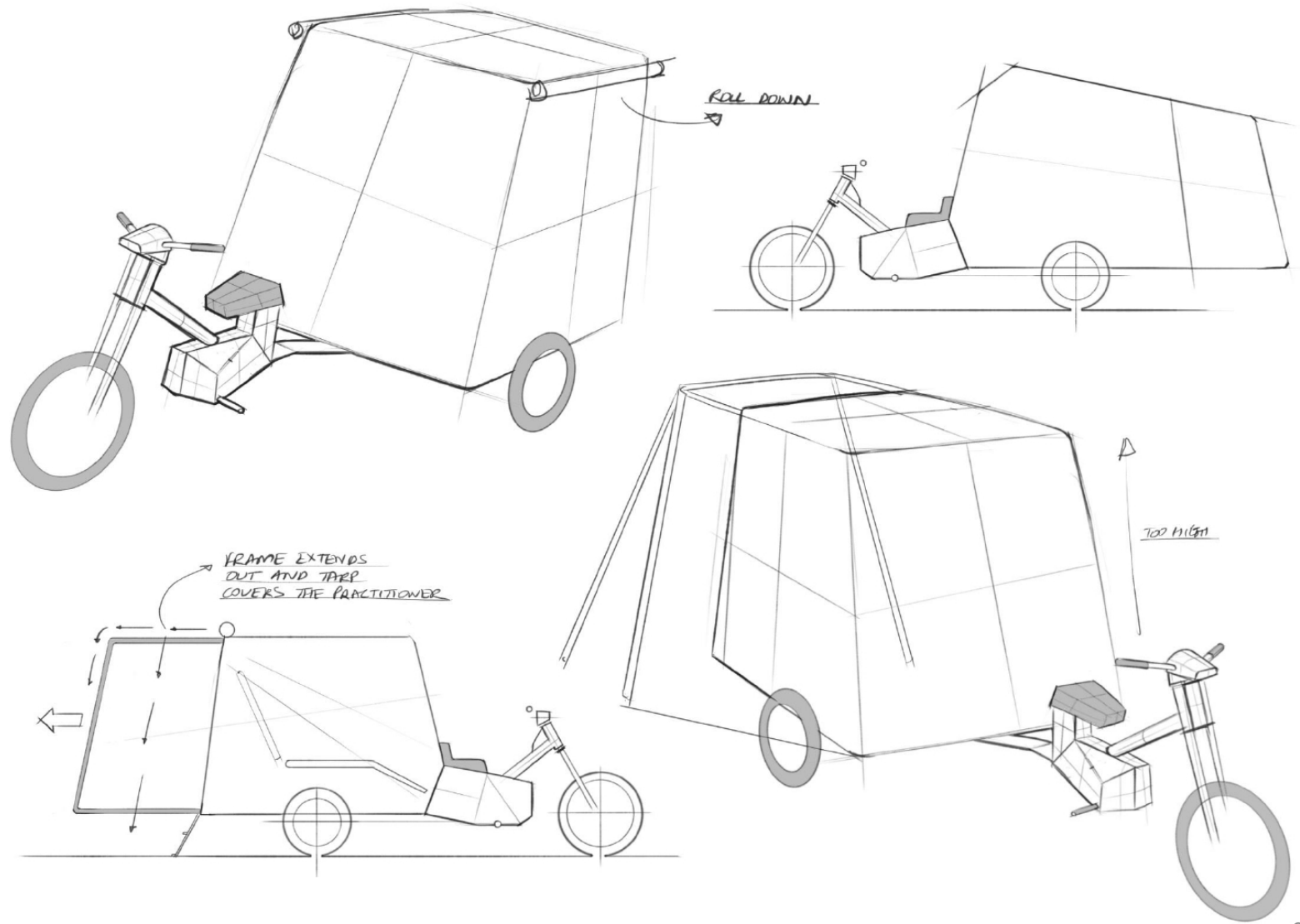



A multi-purpose single unit system that combines the instrument rack, tool tray, cuspidor, suction pump, retractable waterspout and dental lamp.

# CONCEPT IDEATIONS

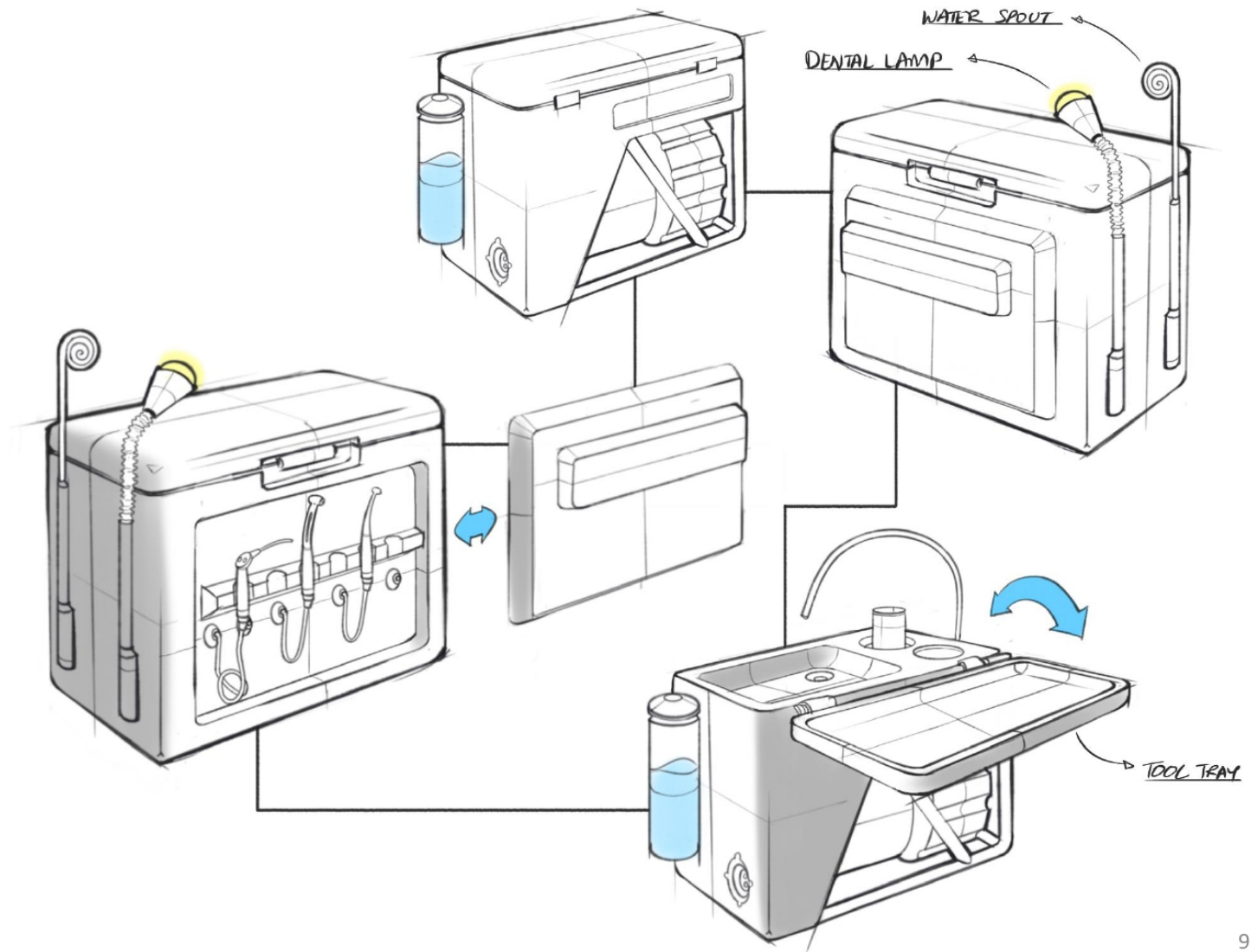

The vehicle is covered completely when it is operational as a mobile dental clinic.

# CONCEPT IDEATIONS

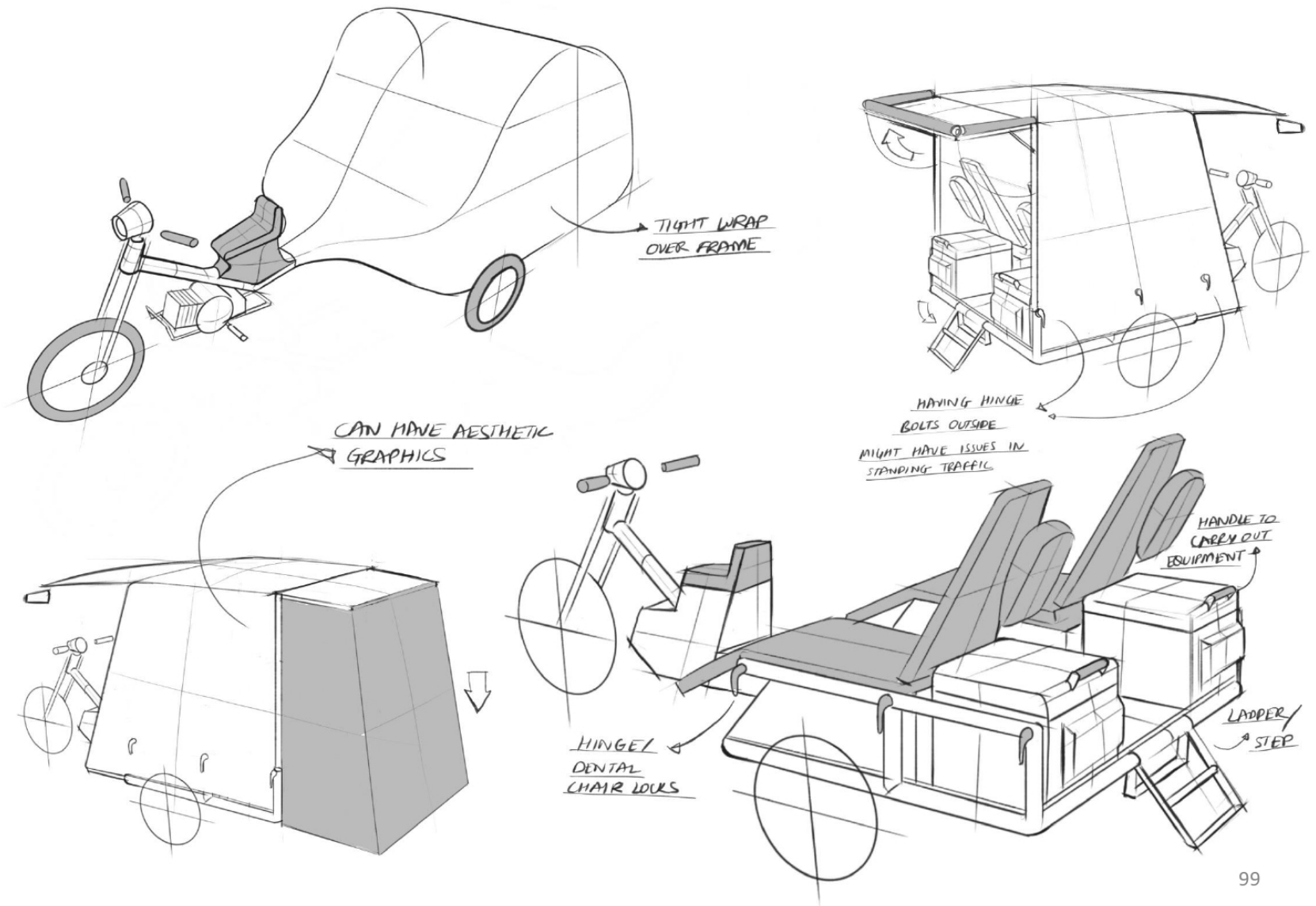

The form of the vehicle is simplified with curves contrasting planar surfaces. The simplified surfaces are easy to manufacture while the curves give the vehicle a visual interest. The vehicle is mostly comprised of a tubular frame and hence, the flat surfaces take away the monotony.

# CONCEPT IDEATIONS

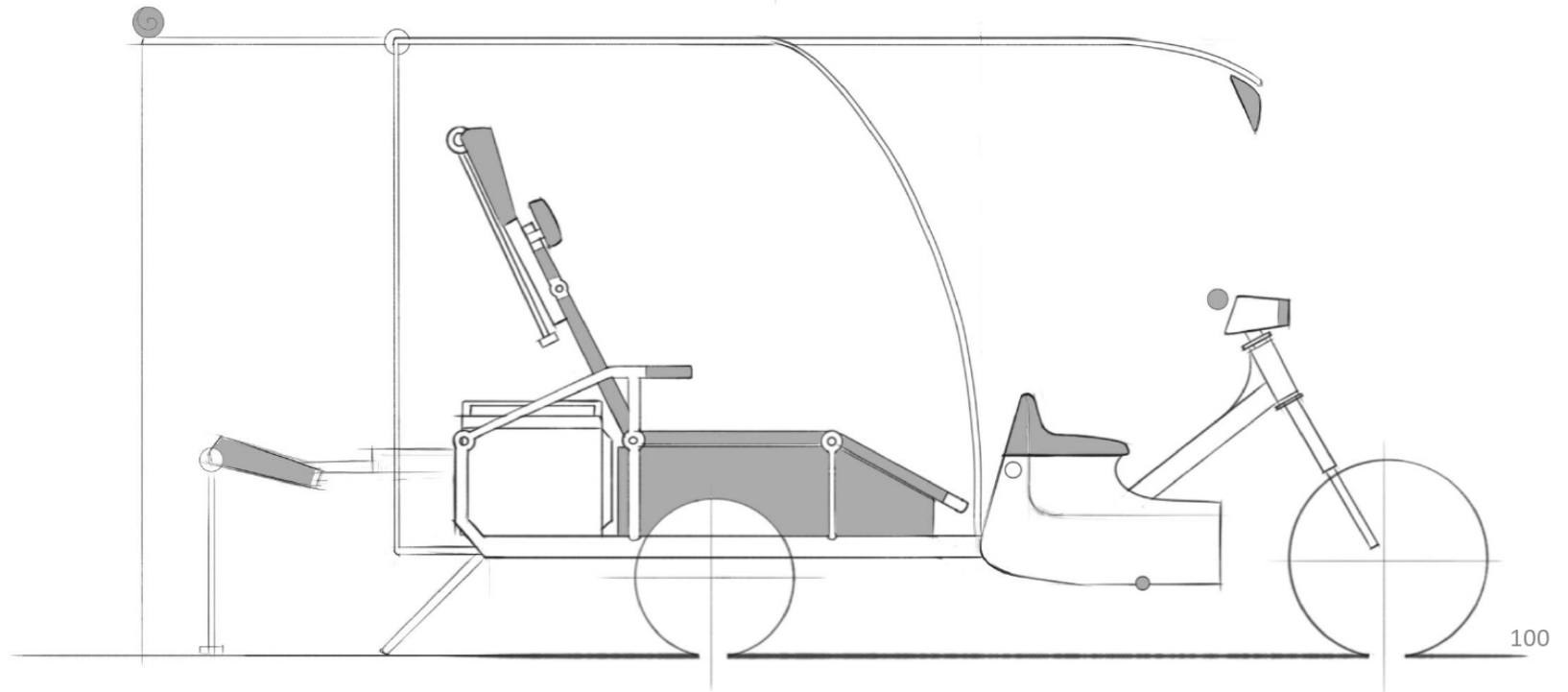
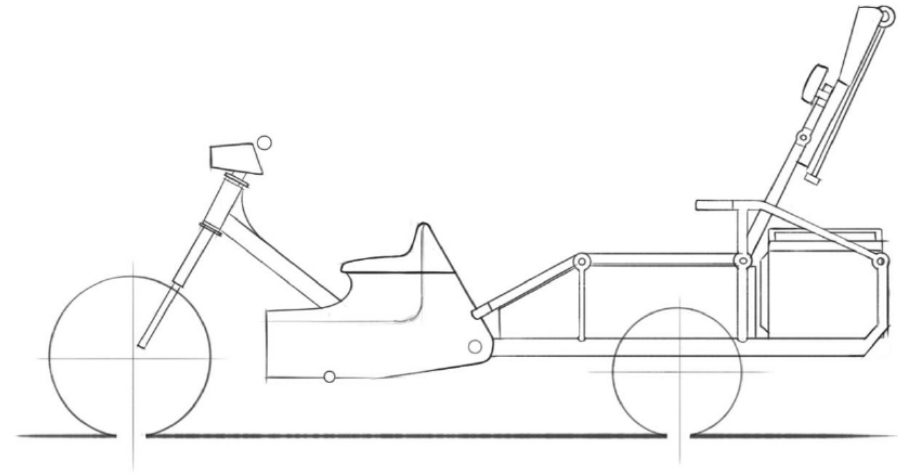

Solid 3D models

# CONCEPT 3D EXPLORATION

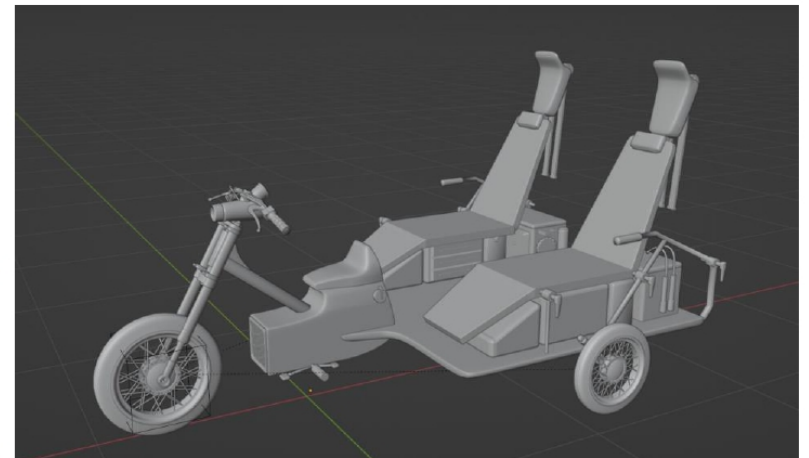
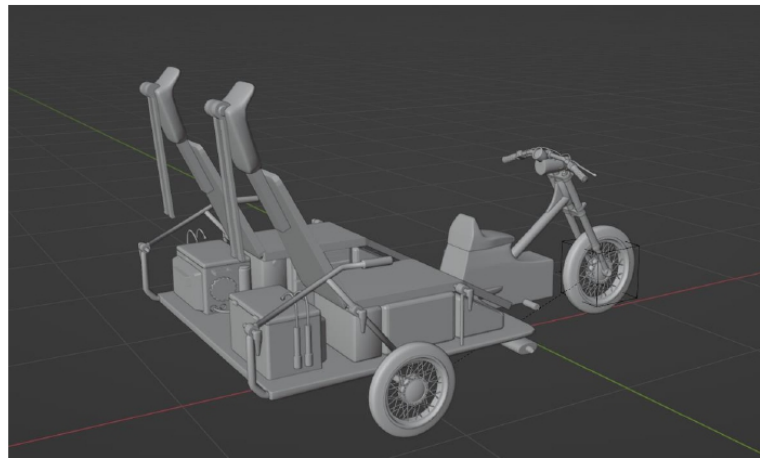
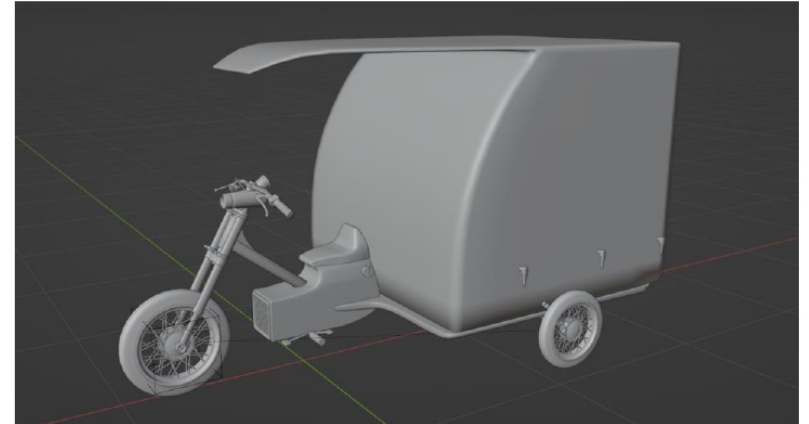
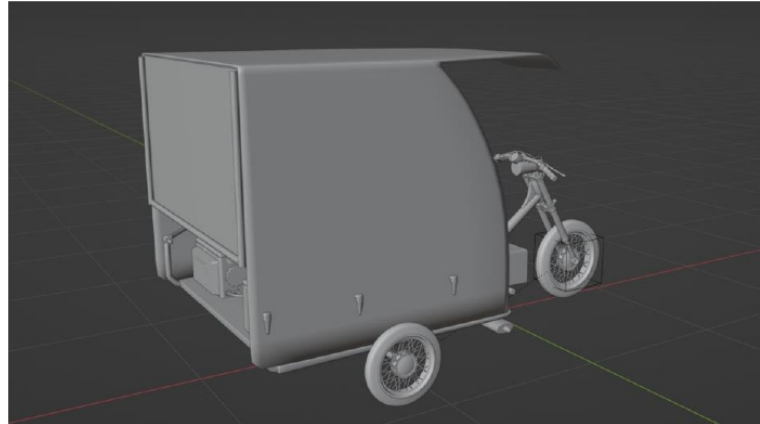



Front and rear  
¾ views with  
and without the  
canopy covers

**CONCEPT**  
**3D EXPLORATION**

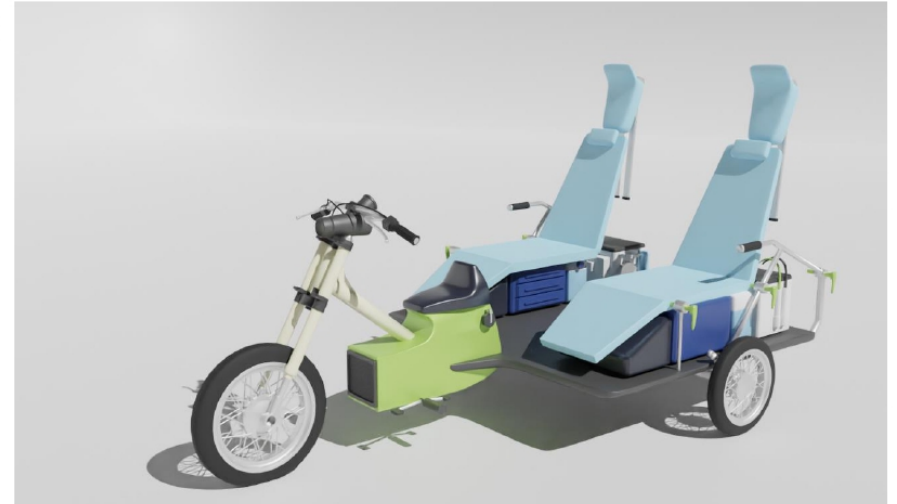

The canopy has a transparent sheet on the top for natural lighting

# CONCEPT 3D EXPLORATION

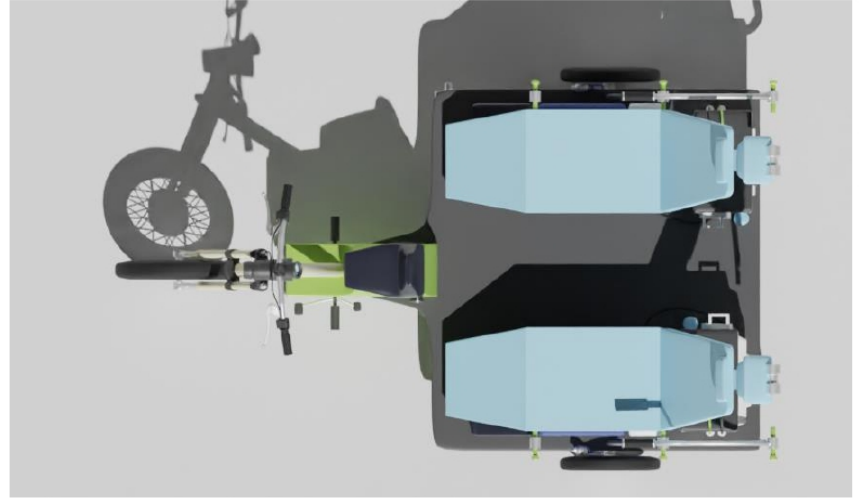
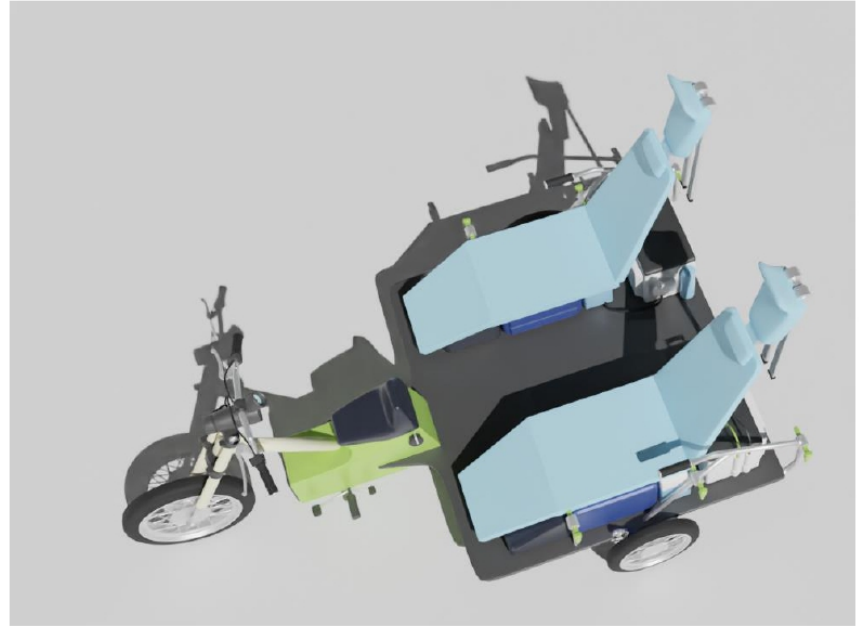
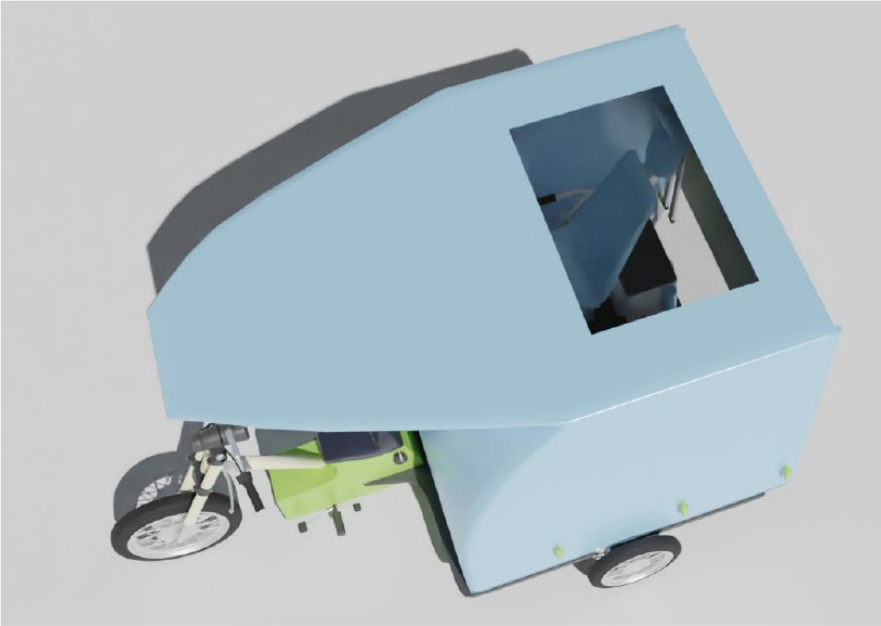

The vehicle interiors in driving and operational positions

# CONCEPT 3D EXPLORATION

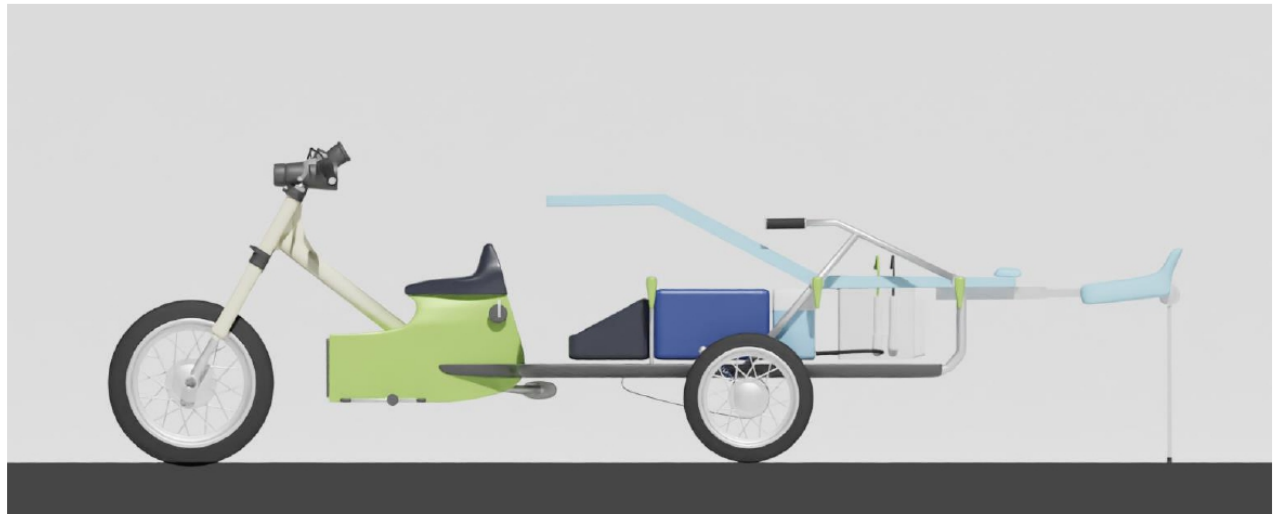
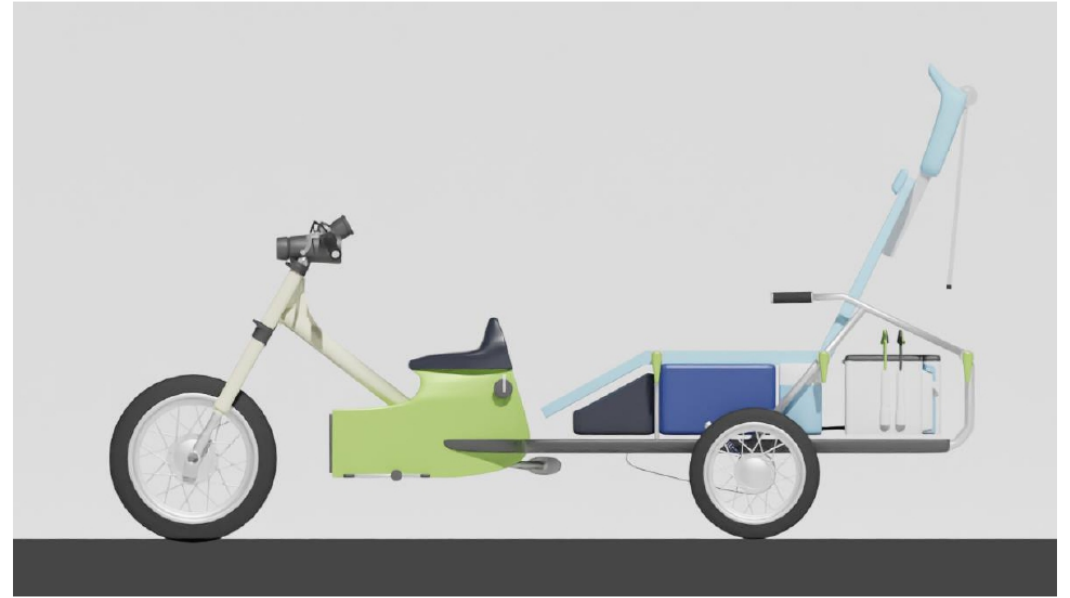

The canopy cover system being deployed for complete isolation while dental procedures are carried out

# CONCEPT 3D EXPLORATION

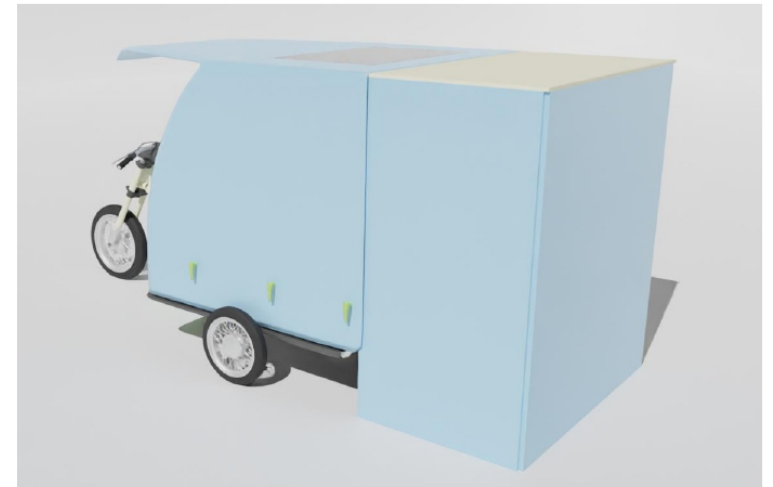

Various components are packed under the seat such as inventory drawers, distilled water cans, dental equipment kit and batteries/fuel tank

# CONCEPT 3D EXPLORATION

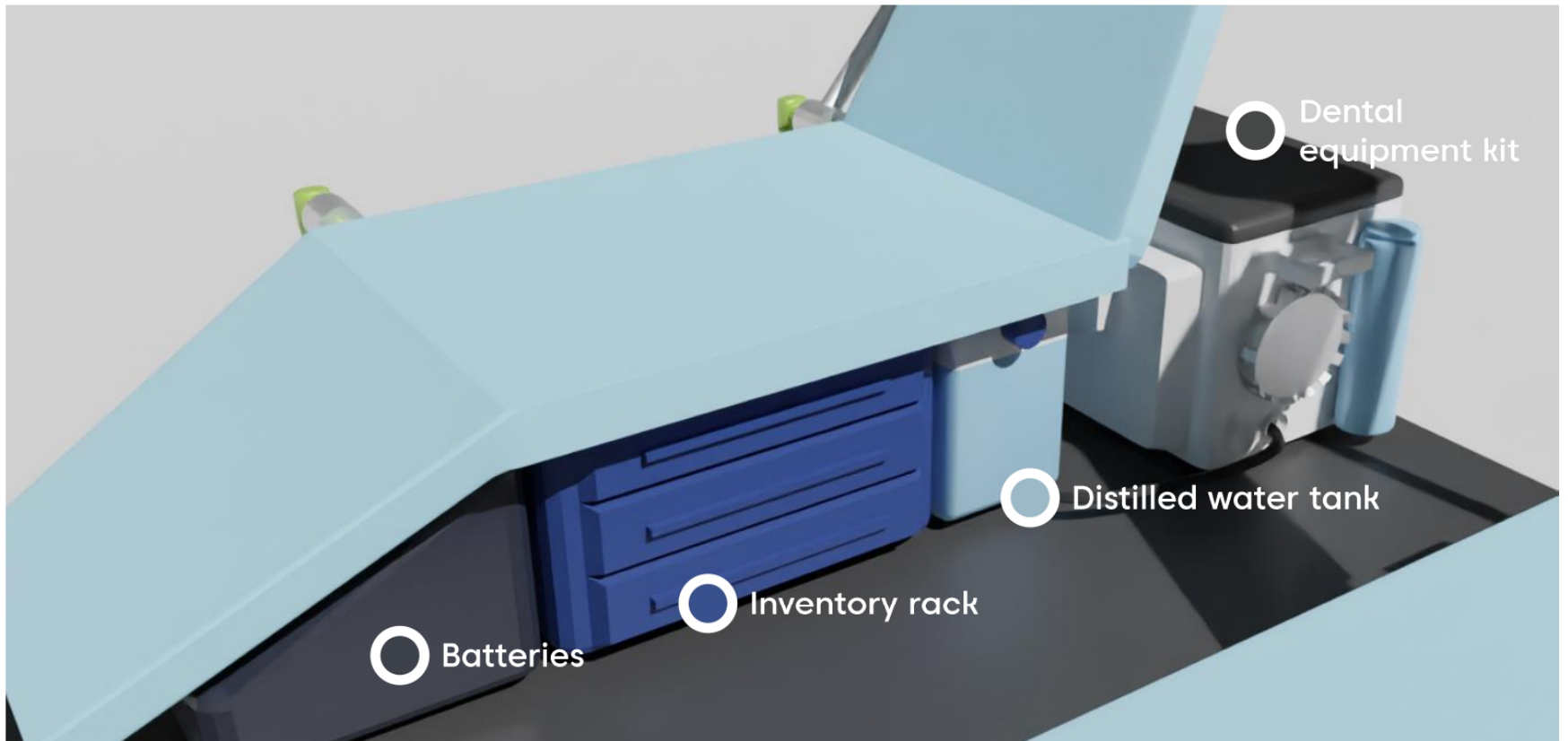

The dental equipment kits are mounted to the sides with open lids and tool tray in operational mode

It is easy for both the dentist and the patients to utilize it, in case of a closed canopy, the dental equipment kit can be placed inside the vehicle

# CONCEPT 3D EXPLORATION

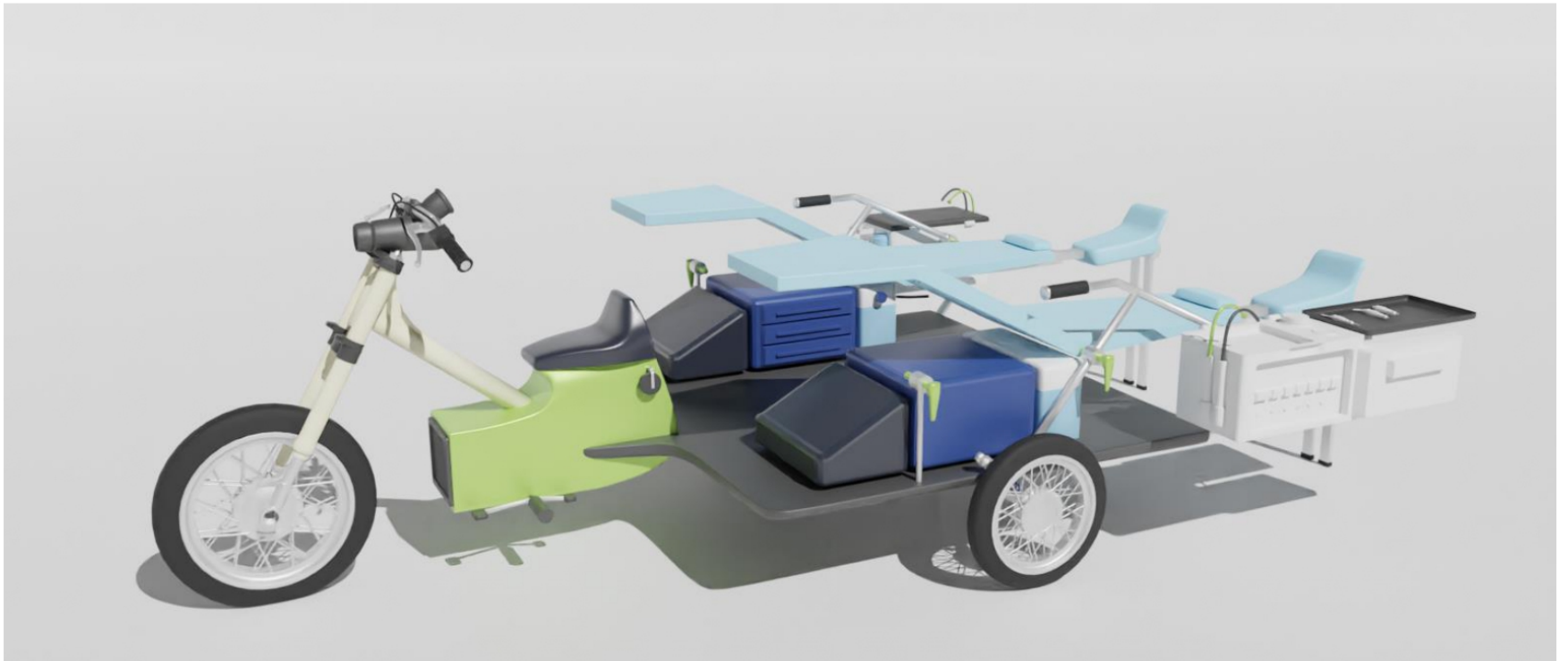

Derived from the scamper ideation studies the platform is simple and easy to build upon and it can provide multiple uses for better rural adaptation

# CONCEPT 3D EXPLORATION

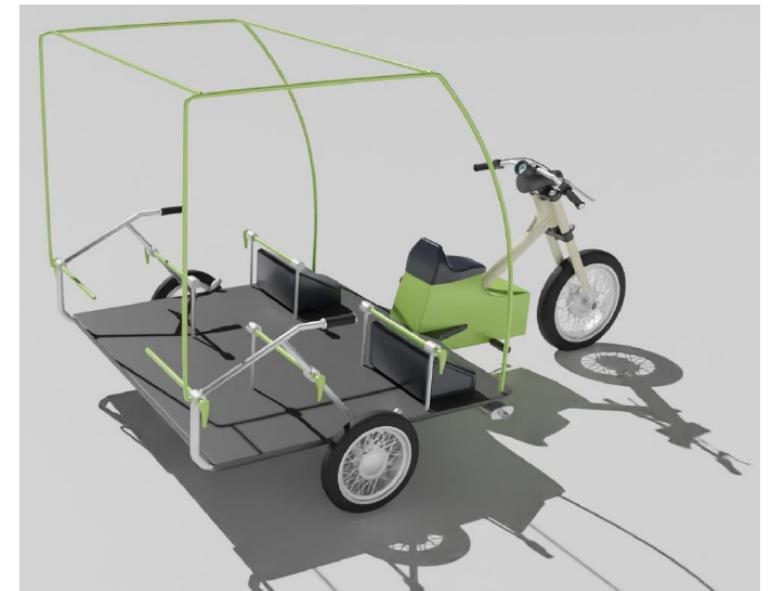
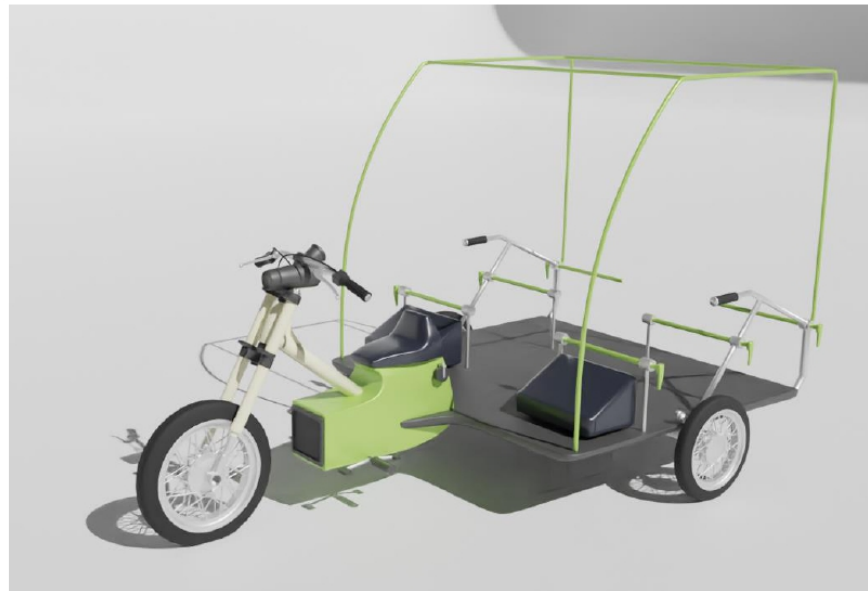

Using the flat sides of the canopy for educational and awareness purposes

# CONCEPT 3D EXPLORATION





Final concept with  
the practitioner  
and the patient

**CONCEPT**  
**FINAL CONCEPT**



The final concept  
in a rural setting  
with and without  
the canopy



**CONCEPT**  
**FINAL CONCEPT**

# CONCEPT USER FEEDBACK

- The sidecar package is interesting as it can be an ultimate end to end solution but there might be issues with the amount of equipment that can be taken along, restricting the level of procedures even further. Also, at least two practitioners (forehanded dentists) are needed for a remote operation.
- A hinge system might cause a lot on unnecessary vibrations and movement damaging the inventory in the vehicle.
- The dental stools can be provided with additional back support.
- The 12 O' Clock position in the final model is adequate for majority of the work.
- The solution can multiply the work efficiency as multiple solutions can be bought and deployed for the cost of a current solution, where a well facilitated solution can cost up to 40-60 lakhs.
- The equipment and technical aspects of the solution can be engineered further to reduce the cost.
- The model is intriguing and can be taken to the field for testing.

# References & Appendix

References and links to the  
literature studied and used



# Initial Ideations and concept

Concept based on  
Package 2

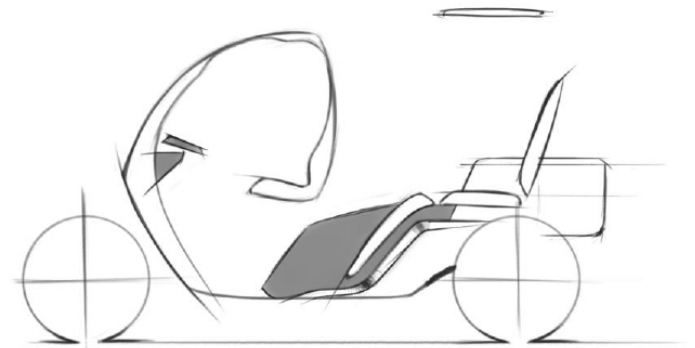
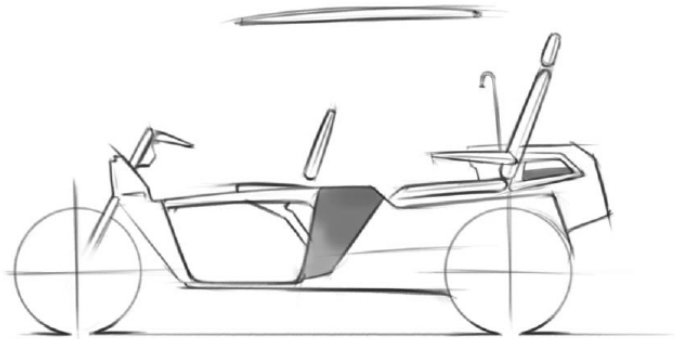
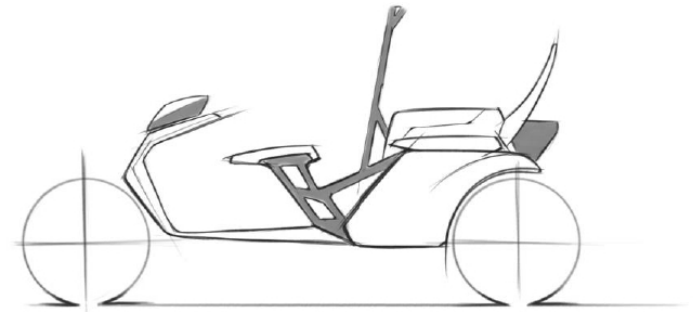
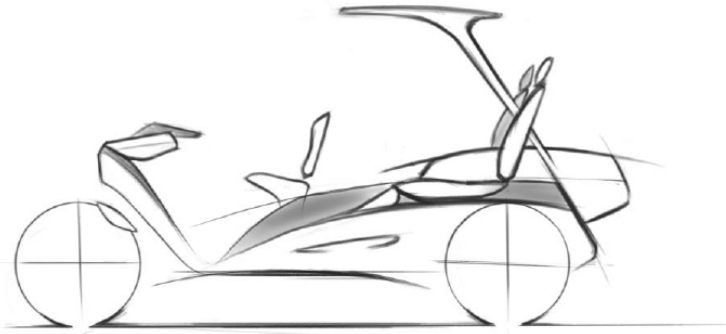

# Initial Ideations and concept

Concept based on  
Package 2

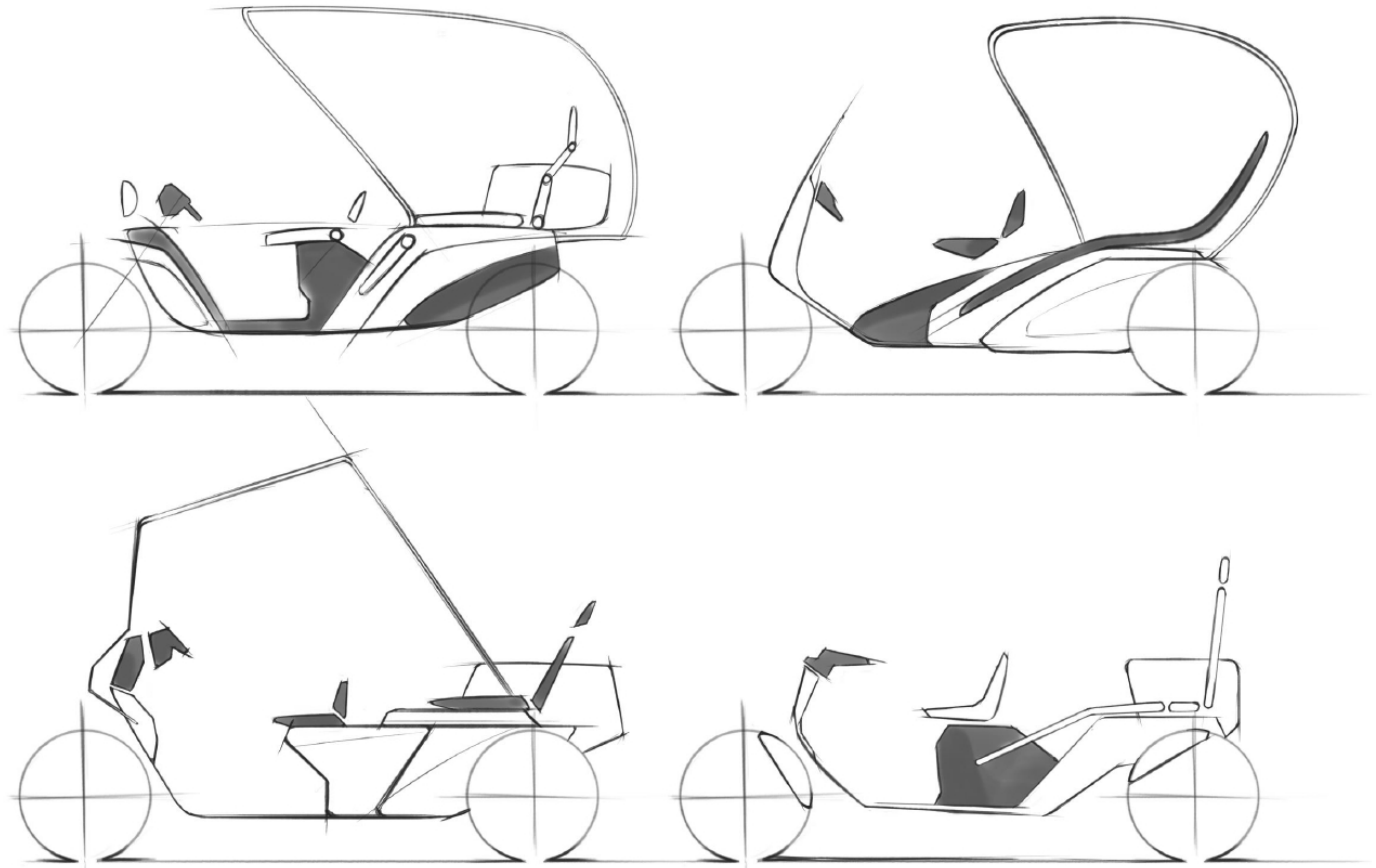

# Initial Ideations and concept

Concept based on  
Package 2

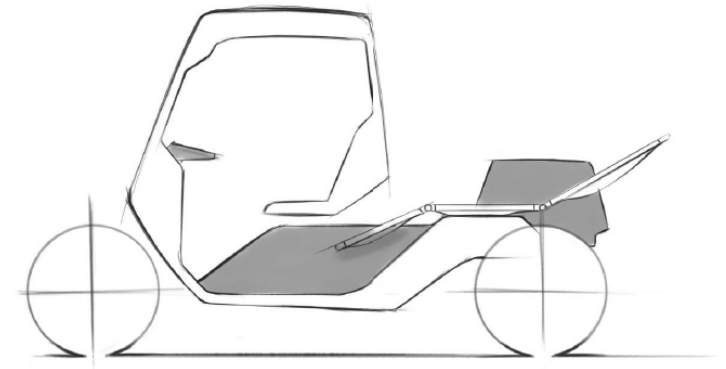
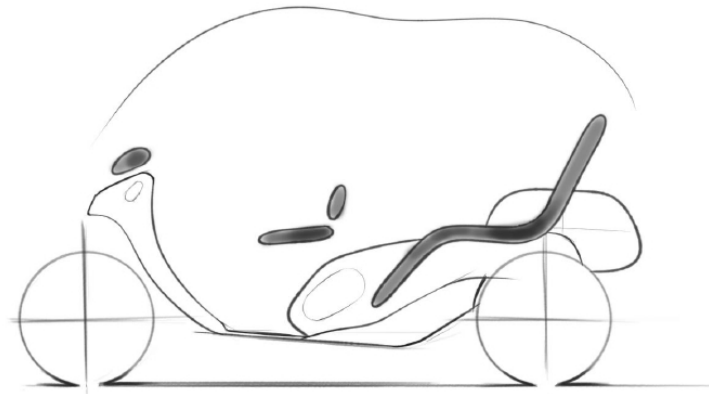
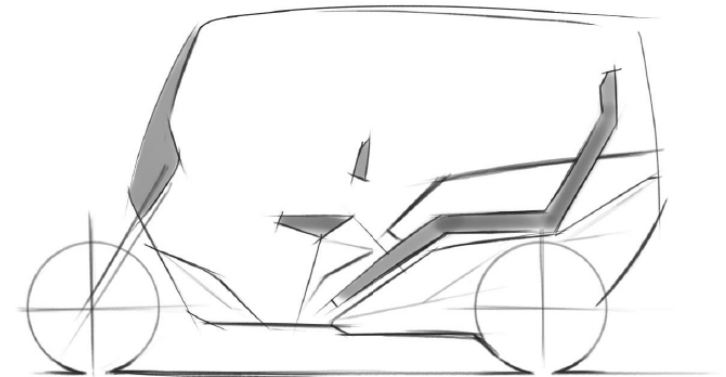
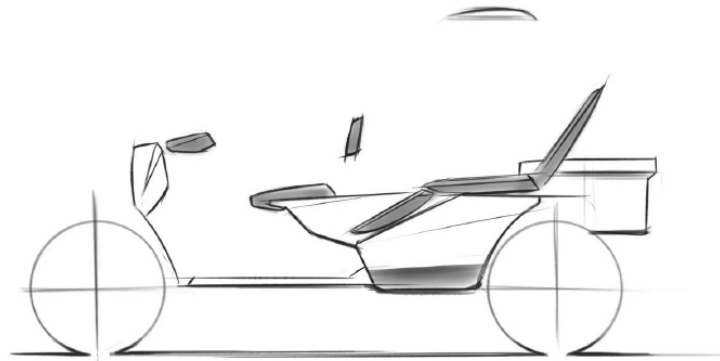

# Initial Ideations and concept

Concept based on  
Package 2

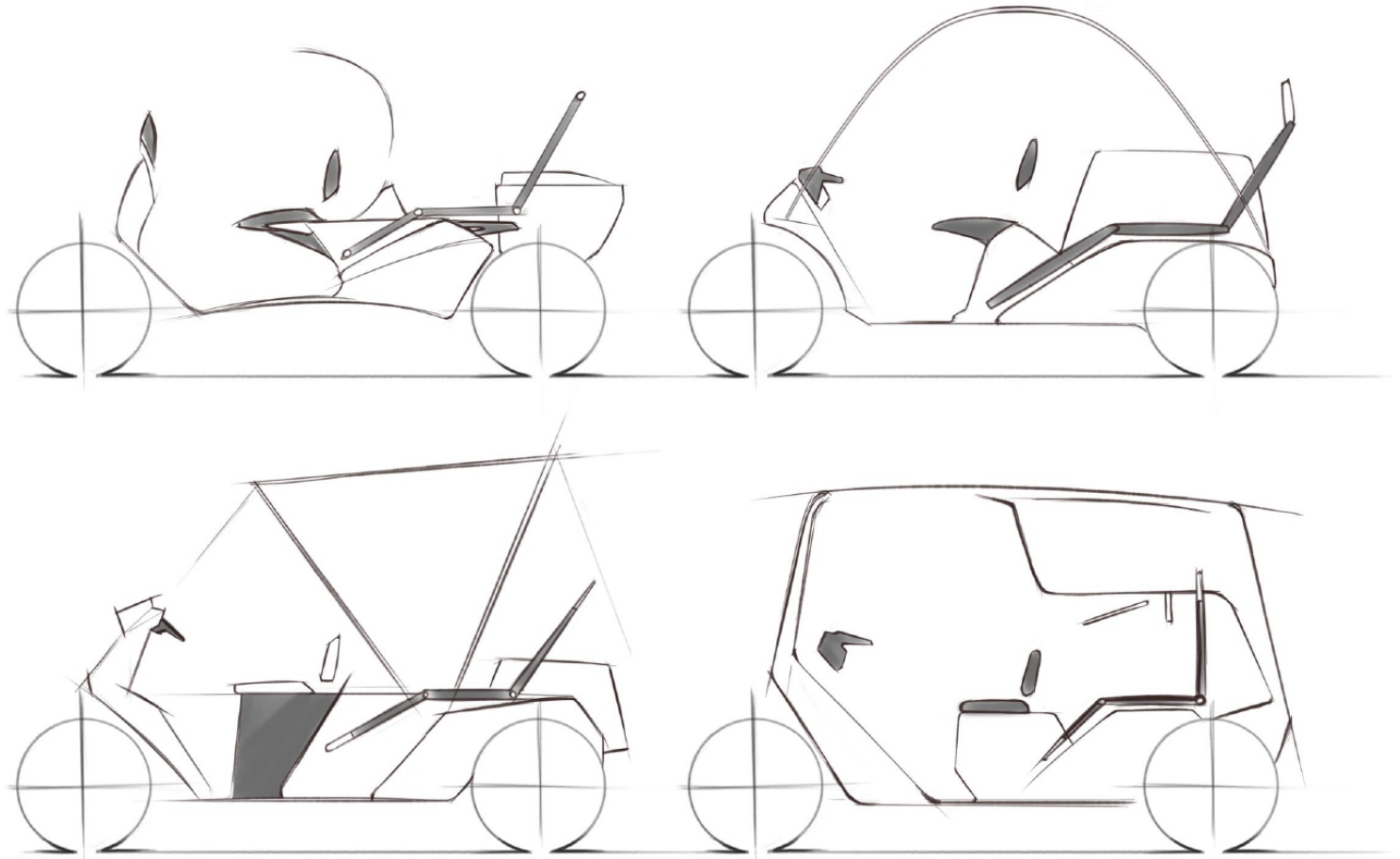



# Initial Ideations and concept

Concept based on  
Package 2

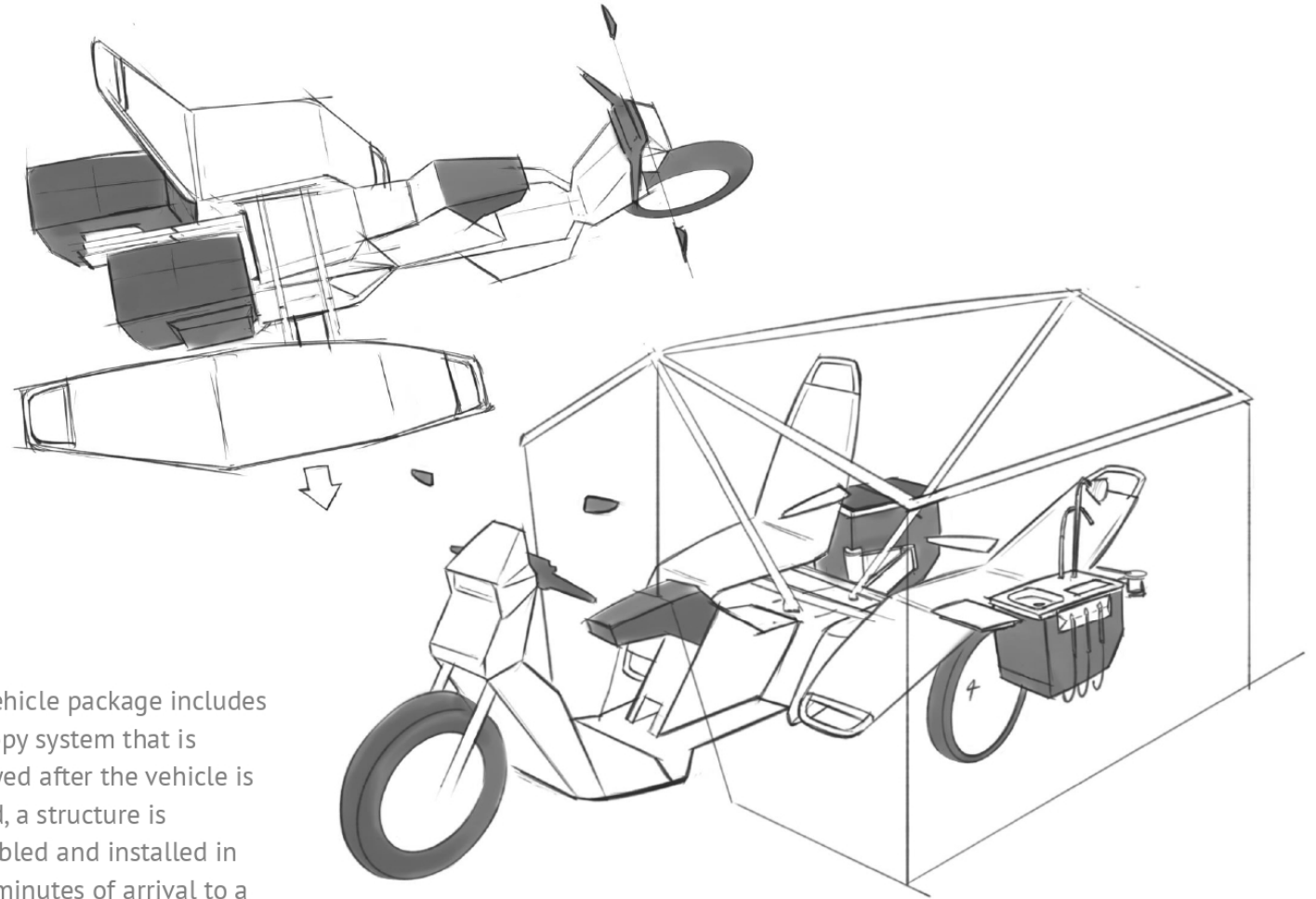

The vehicle package includes a canopy system that is deployed after the vehicle is parked, a structure is assembled and installed in mere minutes of arrival to a safe isolated working space.

# Initial Ideations and concept

Concept based on Package 2

The vehicle is driven to its designated sector by a driver and two dental practitioners. At the destination, the vehicle is established and provided with water and electrical supply. The overhead structure is expanded and covered. At the end of the day, liquid and solid waste is disposed off in the waste bin located under the vehicle.

## Scenario

 Technician    Dental Practitioner

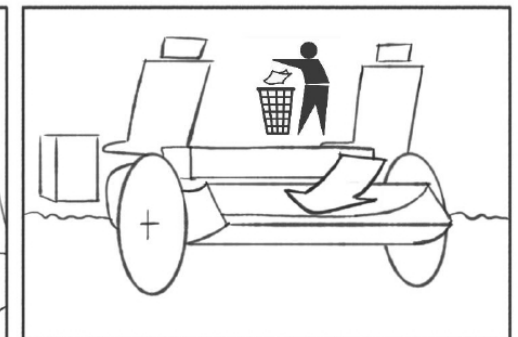
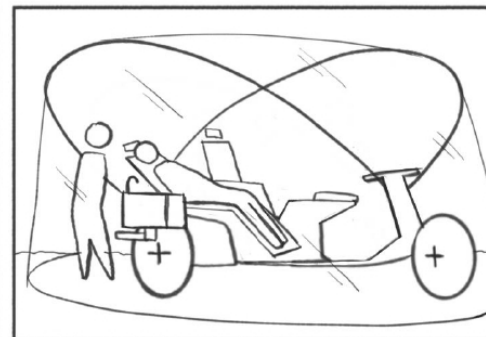
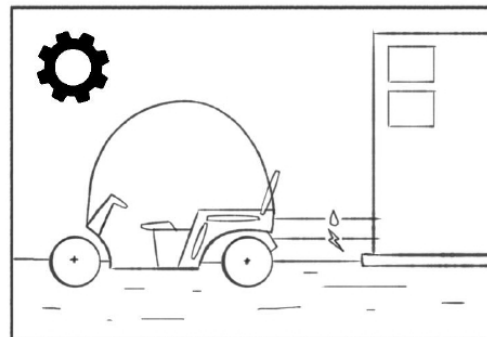
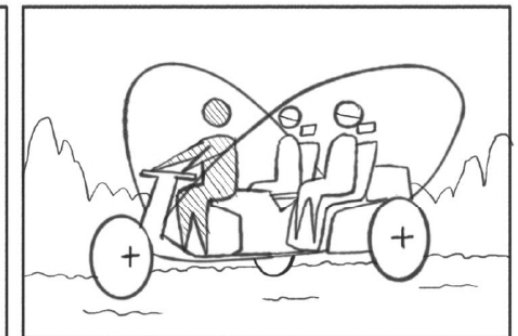
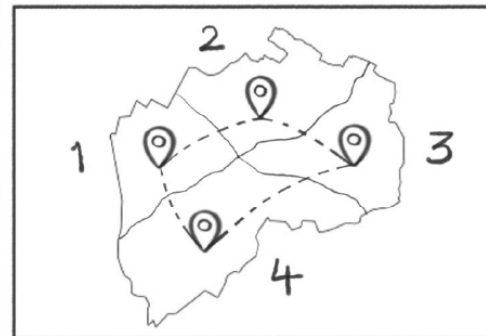
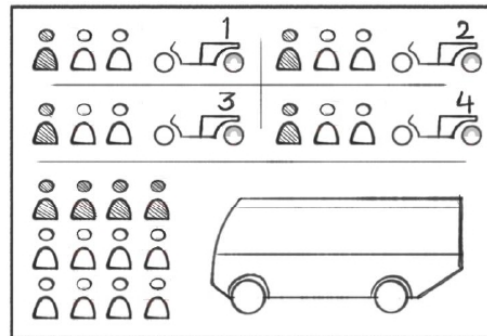

# Initial Ideations and concept

Concept based on  
Package 2

## MINIMAL SURFACES FOR A CLEAN COST-EFFECTIVE DESIGN\_ THEME BOARD

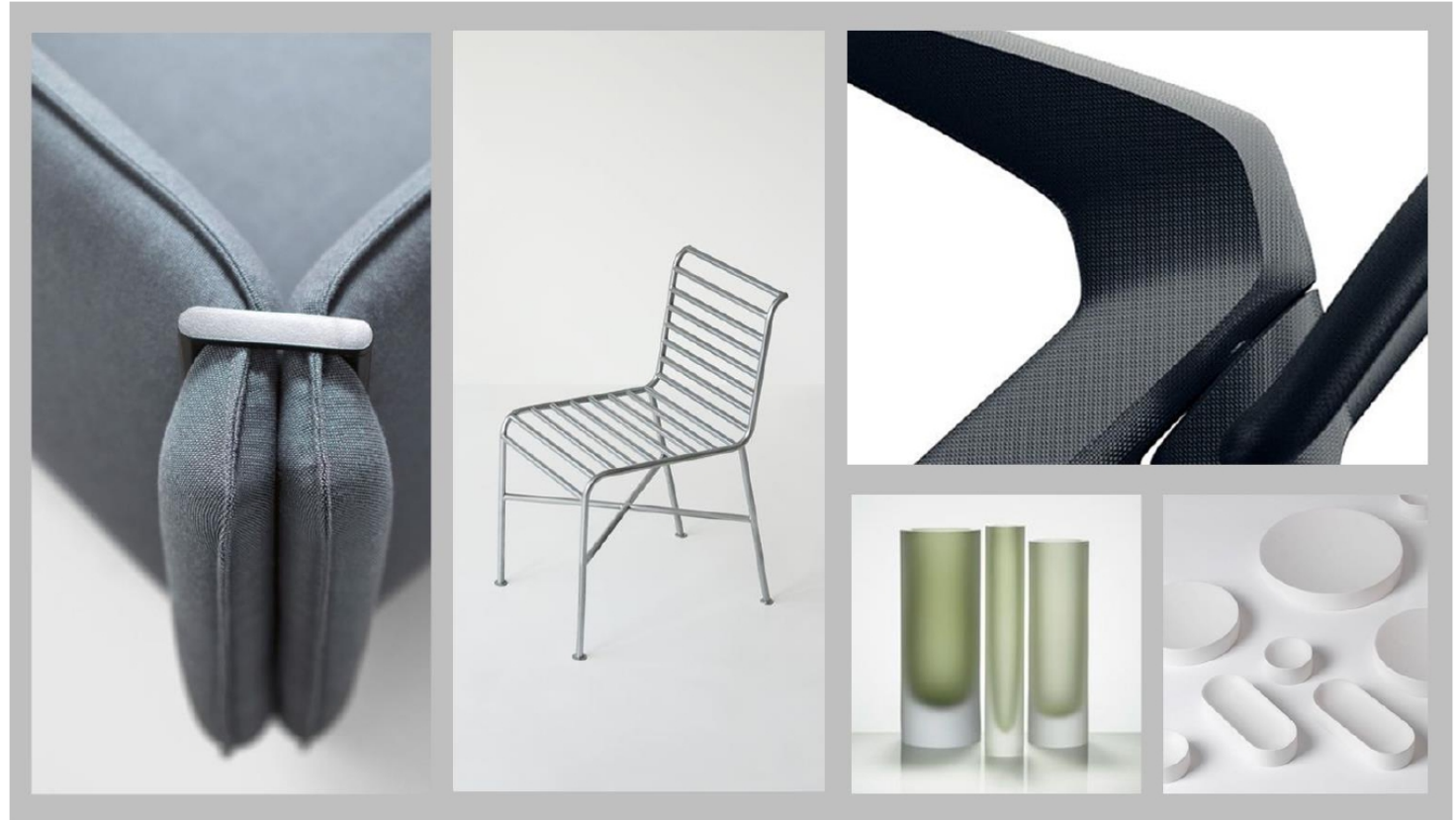

# Initial Ideations and concept

Concept based on  
Package 2

## Concept Sketches

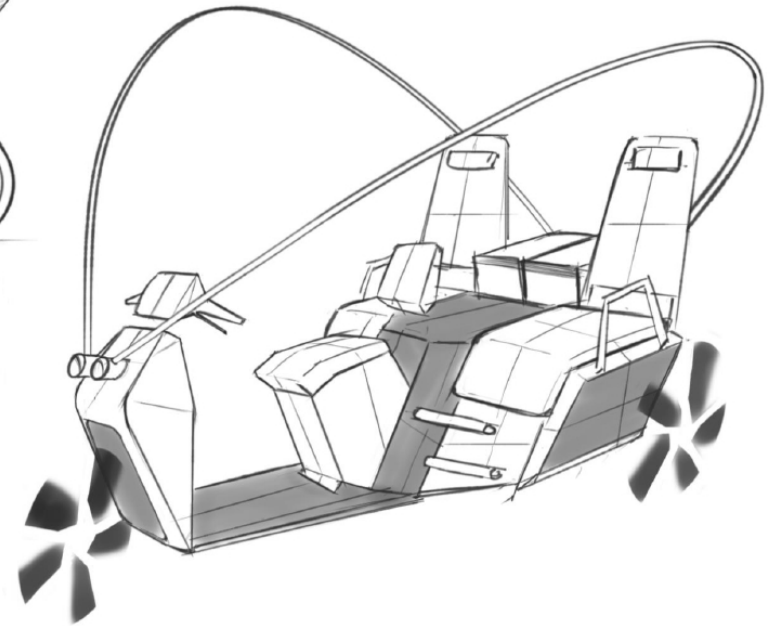
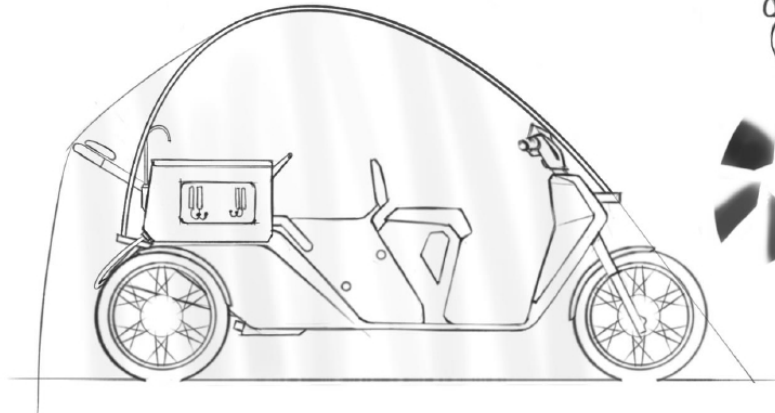
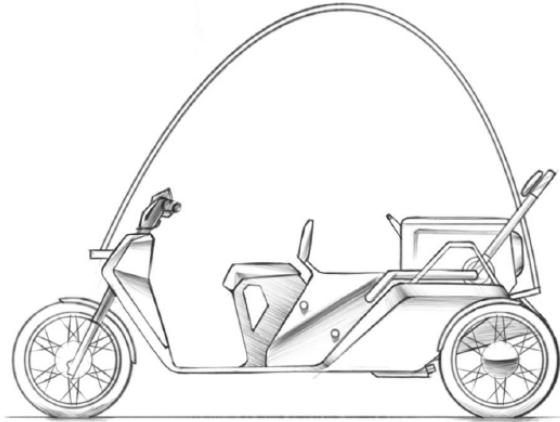

## Initial Ideations and concept

Concept based on  
Package 2

Concept Render

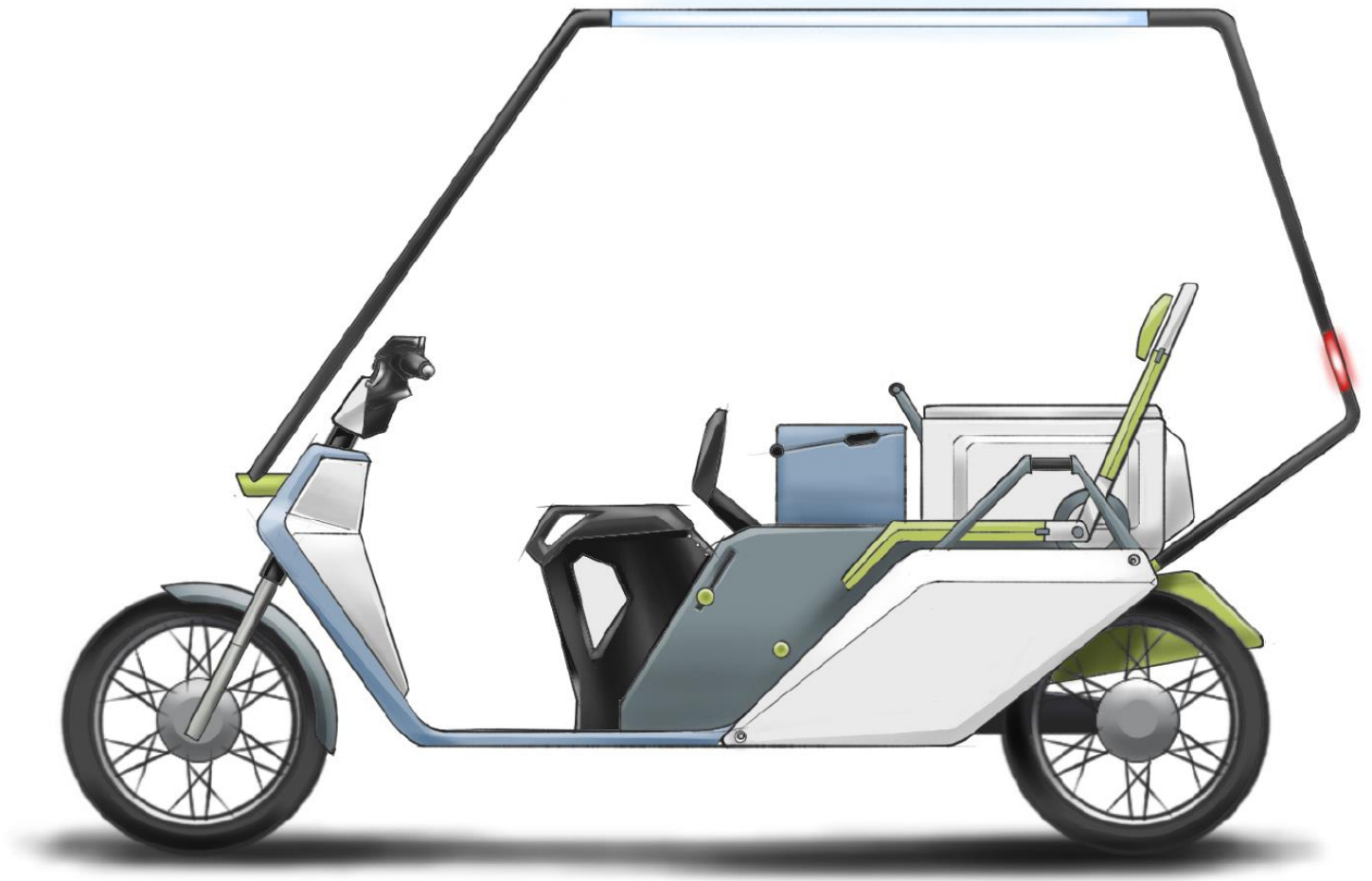

# Initial Ideations and concept

Concept based on  
Package 2

## Concept 3D Exploration

3D concept exploration – forms and surfaces

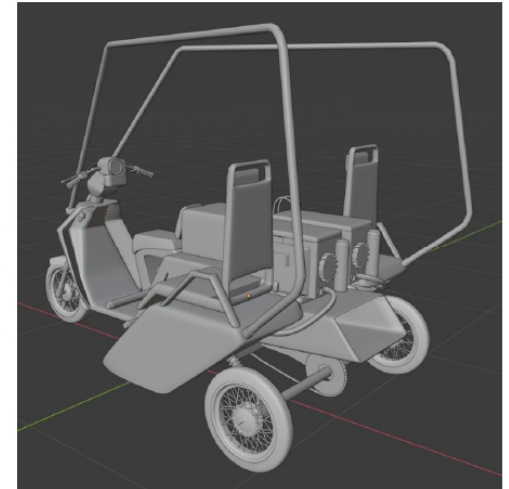
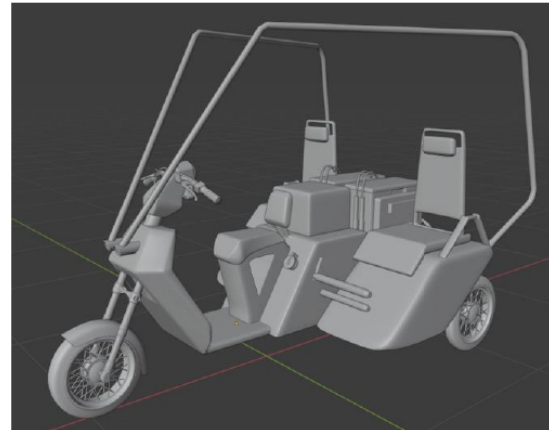

# Initial Ideations and concept

Concept based on  
Package 2

## Concept 3D Exploration

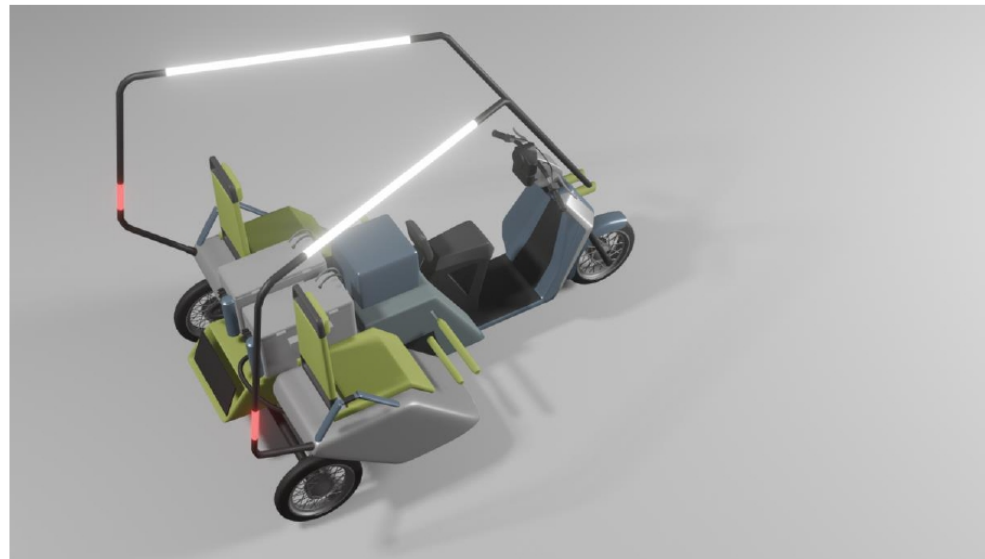

# Initial Ideations and concept

Concept based on  
Package 2

Canopy structure integrated with headlights

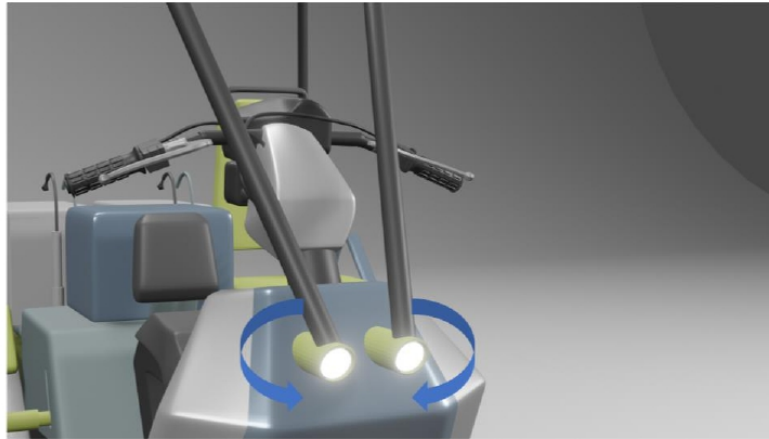

During the procedure, all the waste that is produced can be thrown into the bin mounted below the vehicle

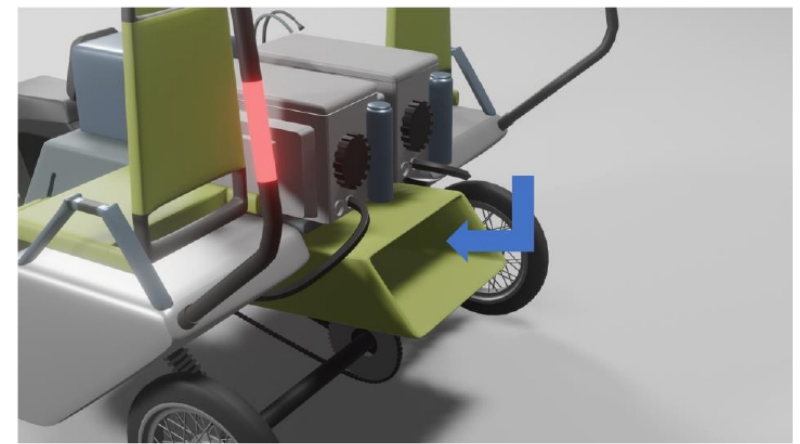

The frame expands to accommodate overhead covering for an isolated environment



The frame expands to accommodate overhead covering for an isolated environment





# Initial Ideations and concept

Concept based on  
Package 2

## Concept 3D Exploration

The equipment kit can be picked up and snapped onto the handlebar next to the dental chair

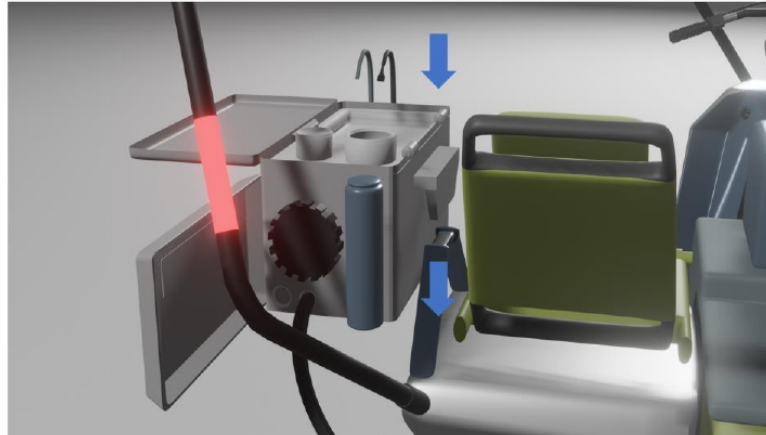

The equipment kit can be picked up and snapped onto the handlebar next to the dental chair

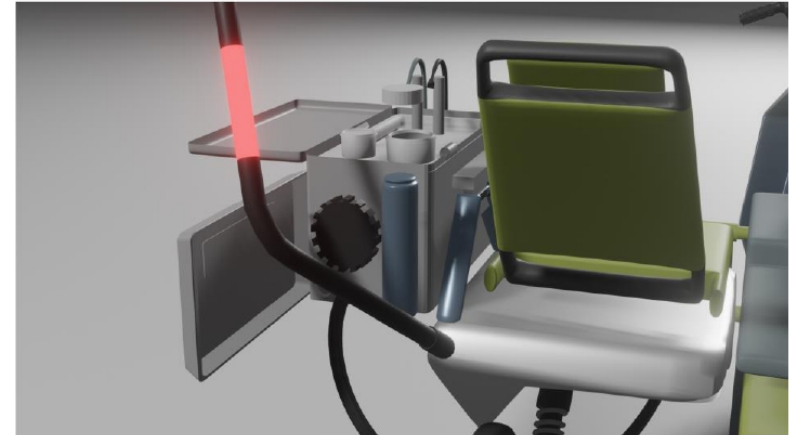

The equipment kit opens up to reveal instruments and dental tools



The equipment kit opens up to reveal instruments and dental tools



# Initial Ideations and concept

Concept based on  
Package 2

## Technical Specifications

### PHYSICAL SPECIFICATIONS

Wheelbase: 1920mm

Total Length: 2940mm

Total Height: 1770mm

Ground Clearance: 160mm

Rake Angle: 28°

Wheel size: 17R

### ERGONOMICS

Driver seat angle: 104°

Driver seat height: 560mm

Dental + Passenger seat angle: 110-150°

Dental + Passenger seat height: 580mm

### POWERTRAIN

Engine: 470cc 4-stroke diesel

Chassis: Integrated frame

Front Suspension: Telescopic

Rear Suspension: Coiled over spring

# Concept Evaluation

## Evaluation and suggestions for the concept based on Package 2

- Best suitable engine type for our vehicle could be an SI engine as they are better for the environment compared to CI engines, have lower cost, are lighter in weight and require less space.
- The vehicle could connect more with the current experience of the primary user (the vehicle Dr Gurleen is using for personal transportation and the vehicle that she travels in for the mobile dental visits).
- Issues for rural women such as privacy and hesitation should be considered.
- The concept should be juxtaposed in a rural Indian setting to better understand its appropriation in its intended setting.
- Height of the dental and the vehicle is too high for dental practitioners, technicalities like stability in a static position and ergonomics of the final solution could be better optimized.
- Ingress and egress of the patient, driver and practitioner should be more comfortable.
- Rationale for the concept must include the rural setting and should be sensitive towards the rural people.
- The vehicle's cost should be decreased even further for better affordability.

## User Feedback

### User feedback and suggestions for the concept based on Package 2

- Oxygen support could be added similar to an aircraft overhead bin as shown in Package 1.
- The dentist might have issues working at such a height and the usual 9 O' clock to 2 O' clock positions will not be feasible, specially for a right-handed dentist for the left chair.
- The smaller the vehicle is, the more appropriate it will be and can be taken out to the fields.
- For a rural setting a multi-purpose vehicle might work as it can be used for vaccination drives or as remote birthing suits.
- A water supply of distilled water is required, while the bottle may be sufficient for a few treatments, one chair requires at-least 10litres of water to work in a day.

## References & Links

Literature reviewed and used

[Mobile and Portable Dental Services Catering to the Basic Oral Health Needs of the Underserved Population in Developing Countries: A Proposed Model](https://www.ncbi.nlm.nih.gov/pmc/articles/PMC4071723/)  
<https://www.ncbi.nlm.nih.gov/pmc/articles/PMC4071723/>

[Oral health concerns in India](https://www.ncbi.nlm.nih.gov/pmc/articles/PMC7254460/)  
<https://www.ncbi.nlm.nih.gov/pmc/articles/PMC7254460/>

[Reach the Unreached – A Systematic Review on Mobile Dental Units](https://www.ncbi.nlm.nih.gov/pmc/articles/PMC4190815/)  
<https://www.ncbi.nlm.nih.gov/pmc/articles/PMC4190815/>

[Issues of Dental Health in India - The Borgen Project](https://borgenproject.org/issues-of-dental-health-in-india/)  
<https://borgenproject.org/issues-of-dental-health-in-india/>

[Utilization of dental care: An Indian outlook](https://www.ncbi.nlm.nih.gov/pmc/articles/PMC3783767/)  
<https://www.ncbi.nlm.nih.gov/pmc/articles/PMC3783767/>

[Why India's big fuel retailers are focusing on rural revival](https://theprint.in/economy/why-indias-big-fuel-retailers-are-focusing-on-rural-revival/613510/)  
<https://theprint.in/economy/why-indias-big-fuel-retailers-are-focusing-on-rural-revival/613510/>

[10 Advantages Of Using Portable Dental Chairs Which You Should Know](https://ivicdental.com/portable-dental-chair-advantages/)  
<https://ivicdental.com/portable-dental-chair-advantages/>

[Ergonomics in Dentistry](https://www.ncbi.nlm.nih.gov/pmc/articles/PMC4144062/)  
<https://www.ncbi.nlm.nih.gov/pmc/articles/PMC4144062/>