



IDC School of Design
अभिकल्प विद्यालय

DEP702

M.DES PROJECT - 2 REPORT

Project Title: **Amphibious Wildlife Rescue Vehicle for Kaziranga National Park**

Submitted by

Angshuman Das

216390001

MVD, IDC School of Design,

IIT Bombay

Under the guidance of

Prof. Nishant Sharma

Prof. Aseef Kadir

Prof. Vivek Kant

Acknowledgement

I would like to take this opportunity to convey my gratitude to IDC School of Design, the Head, Course coordinator, and our professors, Prof. Nishant Sharma and Prof. Sugandh Malhotra for facilitating and enabling me to carry out this M.Des Project -2. I would like to thank my guide, Prof. Nishant Sir, for his continued and invaluable guidance throughout the project and for enabling me to practice and learn Design Thinking, and break the mould of linear thought processes. I would like to thank Aseef Kadir Sir for his persistent guidance, active and enthusiastic engagement, and for facilitating exposure to the methods of the Automotive Industry to enrich my learnings. The experience and knowledge gained during this time are a priceless addition to my journey of being a capable designer.

Lastly, I am grateful to my family and friends who continued to support, aid and motivate me throughout the duration of the project in every possible manner they could.

Contents

Declaration

Approval Sheet

Acknowledgement

1. Introduction	1-2
2. Methodology of Research	3
3. Results of Research	4-10
3.1 Operations	4
3.2 Methods of Rescue: Case Studies	5-6
3.3 Personnel Involved	6
3.4 Modes of Transportation	6-7
3.5 Equipment	7-8
3.6 Human-Machinery Involvement	8
3.7 Terrain	8
3.8 Time of Rescue	8-9
3.9 Animal Behaviour	9
3.10 Human Interference and Injuries in Rescues	9-10
3.11 Human Interventions	10
3.12 Requirements for a rescue vehicle	10
4. Visual Mapping and Diagrams	13-18
5. Insights	19-20

6. Insights for Designers	21
7. Priority Matrix	22
8. Design Brief	23–24
9. Benchmarking	25–28
9.1 Areas of Possible Intervention	25
9.2 Rescue operations around the globe	26
9.3 Specialized rescue vehicles	27
9.4 Specialized Functionality	28
10. Concepts	29–32
10.1 Ideation and Exploration	29
10.2 Direction chosen: Justification	30
10.3 Amphibious EV exploration	31
10.4 Exploration through scenarios	32
11. Platform	33–34
11.1 CAD Exploration of Platform	33
11.2 Technical Package	34
12. Design Exploration	35–40
12.1 Mood Board	35
12.2 Theme Board	36
12.3 Form Exploration	37–38
12.4 3D Translation	39
12.5 Final 3D Model	40
13. Final Design Sketch	41
14. Renders of Design	42–47
15. Scale Model	48
List of Images	49
List of Diagrams	50

Proposed Theme

To design an animal rescue vehicle for Kaziranga National Park during floods.

1. Introduction

Kaziranga National Park and Tiger Reserve (KNPTR) is a World Heritage Site which is home to a large diversity of flora and fauna. The park is known for its large population of animals which is a result of the wildlife conservation initiatives that take place there. Owing to these conservation activities, the park has successfully managed to grow the population of the endangered species of one-horned rhinoceros, which accounts for 2/3rd of the entire world population of the species.

With a large population of species and a large variety of them, comes the challenge of a diverse range of rescue operations that need to be deployed across its 1085 sq. km. throughout the year. Birds, reptiles, and mammals of all sizes have to be rescued from difficult terrains and situations and require specialized sets of operations and equipment to complete the rescues effectively and efficiently, minimizing the harm to both the animals and the humans involved.

Flood is the backbone of productivity of the ecosystem in KNPTR. Annual floods replenish nutrients by redistributing fishes and plants. The flood maintains the habitat and prevents the grasslands from turning into woodlands, which is critical for the species that exist there. The flora and fauna of the park are water-dependent. Mud is also critical since the mega-fauna including the one-horned rhinoceros and wild buffaloes use mud for heat exchange since they don't have sweat glands. Currently, the Park is closed to tourists, and it remains closed typically from May to September due to floods and their aftereffects.

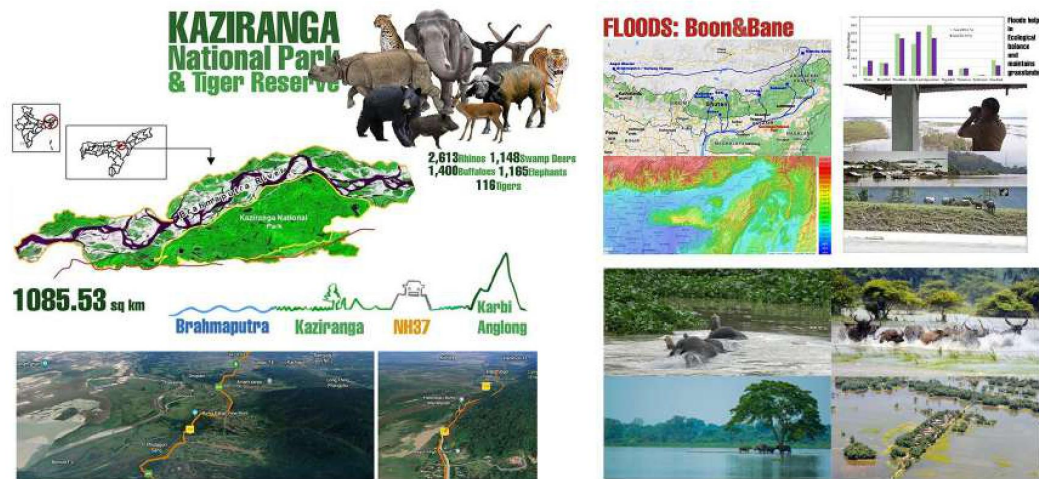


Fig. 1b Floods in Kaziranga



Fig. 1a Location and Ecology of Kaziranga

2. Methodology of Research

The primary research was conducted across four days from 21st Aug'22 to 24th Aug'22 at one location in Guwahati and multiple locations inside Kaziranga National Park and Tiger Reserve (KNPTR). Personal Interviews were conducted where the respondents were asked a series of questions that aimed to understand the following areas of interest:

- The need, severity, urgency, frequency and types of rescue operations conducted
- The methods and procedures used in the operations
- The impact of floods on rescue operations
- The challenges encountered in the process and how they are tackled
- The types of equipment and vehicles employed in the field and their effectiveness
- The evolution of the techniques over the years
- The types of terrains
- The human–animal interactions
- The needs of the personnel for swifter rescue operations

The interview and questions posed were unstructured and informal in nature and all relevant remarks of the respondents were noted on paper. Where suitable, relevant photographs and videos were recorded on a mobile phone. A total of 18 respondents were interviewed. Respondents include personnel from the Assam Forest Department, including the DFO, Forest Guards, Forest Ranger, Animal Handlers, Veterinarians, and Drivers. Respondents from external organizations include personnel from the Wildlife Trust of India, Aranyak, and the Centre for Wildlife Conservation and Rehabilitation (CWRC). All the respondents were notified about the project, its purpose and the aim and intentions of the interviewer prior to the interview.

The responses from the interviews were segregated and made comprehensive to gain insight into the rescue operations that happen in and around KNPTR.

Key insights were deduced from the general insights to narrow down specific areas of interest.

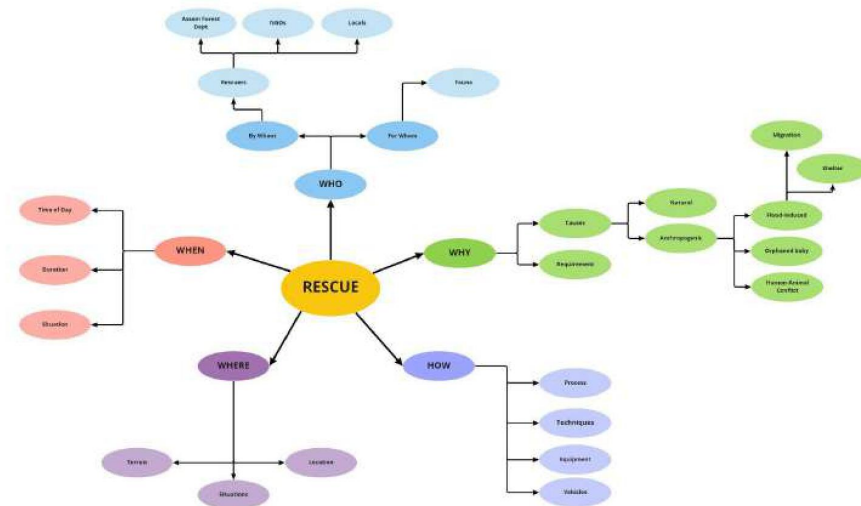


Fig.2 Mind Map for data collection through unstructured-informal interviews.

3. Results of Research

3.1 Operations

Rescue operations happen in Kaziranga throughout the year and every operation is unique in terms of the situation, location, fauna involved, condition of the fauna involved, accessibility, equipment available and safety considerations. CWRC alone has rescued 8276 animals till August'22 since 2002. The rescues are broadly caused either naturally or due to anthropogenic causes. Rescuers do not interfere generally if the causes are natural even if an animal is injured or suffering, since natural situations maintain the ecology and the ecosystem of the Park. Even during floods, animals that are fit survive. The rest perish by drowning, starving or fear and become food for other organisms in the park. Most of the rescues are done in situations where anthropogenic causes are involved, where there is some interference between animals and humans. This may range from an animal entering human settlements, an animal being shot, burnt or injured by humans, babies getting isolated from mothers, an animal hunting cattle or entering crop fields, and animals getting stuck in human-built structures and terrains. During floods, the frequency of such conflicts increases due to obstruction in the natural migration paths by humans. Calves get stuck in human residences due to confusion and seeking shelter, animals get injured while crossing the NH37, animals fall into wells, get bitten by pet dogs, and get injured when chased by humans. Rescue operations are thus mostly done outside of the park, where there are human interventions in an otherwise natural ecosystem.

All the rescue operations for different types of fauna are different. During monsoon season, all rescues are flood induced. During this season, hog deers, reptiles, rhinos and tigers are the most rescued animals. During winters, bird rescues increase. Birds have the lowest release rates among all the rescued fauna and they mostly die during care.

Considerations in Rescue Operations

Rescue operations need to be completed as soon as possible for the animals' welfare. Human and Animal safety are the top priorities in any rescue. No compromises are made in either case, although the priority is slightly more towards the safety of the rescue team. It is advised for the team to not engage emotionally in a rescue situation and put themselves or others in danger.

If an animal is not accessible due to its location and surroundings, an operation is not conducted there. The animal is driven towards a safer location to minimize risks. They are taken away from waterbodies or places with fall hazards since an animal takes time to sedate after it is tranquilised.

Animals are guided and driven generally by loud sounds. Blank fires, crackers, horns, and screams are some ways to generate these sounds.

It is always preferable to physically restrain the animal using nets and ropes and not opt for chemical methods (such as tranquiliser) since chemical methods have medical implications post-rescue. Chemical sedation is necessary in case of predators, aggressive and agitated animals, and large animals.

Most of the techniques are thought on toes and are mostly makeshift exercises.

3.2 Methods of rescue: Case Studies

- An adult rhino had gone out into human settlements outside the park and was feeding on crops, in a maize field. It was shot with a tranquillizer dart by a guard who went in on an excavator, after which the rhino strayed deeper into the field. After it was sedated, it is blindfolded with a green cloth and then rolled onto its side. A 1foot pit is dug beside the rhino where a wooden sledge, the size of the rhino, is placed. Belts are passed under its belly near the legs and the rhino is rolled onto the sledge by humans. The excavator then drags the rhino and the sledge outside the field to a landing where a truck (Tata 709) could access. The excavator dragged the sledge through a wooden cage which was closed when the rhino was inside its boundary. The rhino was revived from sedation and the sledge was dragged out from the cage. A crane stationed beside the truck lifted the cage along with the rhino onto the truck. The crane also dropped the cage out of the truck and into the ground when the truck reached the wild.
- An adult tiger was spotted inside a residence and was locked inside the room by residents. The tiger was sedated by shooting a dart through an opening in the wall. After the animal was sedated, his eyes were covered and was lifted onto a stretcher by 4 people. The tiger was carried outside to an open space where it was treated by the veterinarian after which it was carried onto a metal tiger cage mounted on the back of a Bolero Camper. Once the stretcher was removed, the tiger was given a dose for revival and the cage was closed immediately. The tiger was transported to a release spot by the highway and the way was cleared by forest personnel by slashing out parts of the foliage and blocking the rest of the road with 3 other vehicles. When everyone was safely back in the cars, the cage was opened from the front by one person and the tiger was let out by itself. The animal chose to run into the jungle.
- A wild elephant had strayed out into human settlements and had trampled 5 villagers. The forest officials searched for the animal with drones and domesticated elephants. Once located it was tranquilised and its legs were bound with ropes. Wide belts were passed under its belly near the legs since elephants have an open rib cage and lifting them by their bellies can cause extreme pressure on their hearts. The belts were then attached to a crane, and the animal was allowed to stand with assistance from the crane. Then it was lifted onto a Tata 709 truck and transported to the park.
- A mother rhino was killed, and the calf was stuck with its mother, still trying to feed on the dead mother's milk. The calf in this situation was immobilised by rescuers using force, it was blindfolded with a green cloth to calm it down, and with its legs tied with Cotton ropes, it was lifted on a stretcher onto a pickup truck bed. It was carried back to a rehabilitation centre where it was cared for in a replicated ecosystem for 3-4 years and then released back into the wild where rehabilitation and observations still continued in the natural environment.
- A sub-adult elephant had fallen into a tea garden irrigation drain when trying to cross the garden with its mother. The mother was frantically trying to help but failed. The mother was aggressively trying to chase away rescuers so the officials fired a blank shot to scare away the mother. The baby was pulled out by ropes after the drain was widened using an excavator. After release, the elephant went forward and fell into another drain. The same procedure was repeated and the rescuers immediately fled to a distance to let the two elephants reunite.
- Three tigers, one mother and two cubs had strayed into the nearby villages to train for hunting. They practised on easy prey i.e. cattle. It took 3 days for rescuers to locate the tigers while patrolling on elephant backs due to their stealthy nature. The cubs were located and tranquilised at separate times from elephant backs and then transported on tiger cages to similar areas of the forest.

- In an operation in a 10-12 ft tall jute field, rescuers had hired a civilian tractor to search for a rhino that was spotted in the field earlier. The civilian had insisted on driving his own vehicle. In the field, a full-grown rhino had appeared in front of the tractor and had charged towards the vehicle. It rammed the front, bit the bumper and lifted the tractor off the ground and slammed it down thrice. The forest guard dropped his dart gun in the commotion. The driver had climbed onto the roof of the tractor. The forest guard honked the horn and revved the engine to finally scare off the agitated rhino.
- Snakes enter human residences, generally big pythons, which are captured using a snake capture kit. The snakes are captured and put in a cage, made especially for the type and size of the reptile.
- Hornbills nest inside tree trunks and the mother and its hatchling stay inside the trunk which is sealed from the outside by the male. The male provides food to the mother and hatchlings. In one case, the male hornbill had died and the mother was stuck inside a wooden tree with its hatchling with no food. Rescuers located the nest after discovering the dead bird and shifted both birds into an artificial shelter.
- Big predators are captured by baiting using goats and pigs inside specially designed cages that close when a tiger steps on the trigger. This eliminates the need for direct human interaction in a capture process since tigers are otherwise very aggressive and frantic when outside the park. Cages for tigers are camouflaged and earlier utilised a mechanism similar to a guillotine setup using bamboo and ropes. The newer cages use a similar mechanism but are built-in with the cage in metal. They are heavier and difficult to handle manually. Once the animal is caged in, it is impossible for a human to go near it or even lift it. Tiger older cages could only be used once since the animal would damage it in an attempt to break free.
- A leopard had fallen into a well. A rescuer had to go into the well and tie the animal to their back, making sure that its breathing is not hampered.

3.3 Personnel Involved

In a typical rescue operation, the core team consists of 10-12 people. Of which 2-3 people are technical people, 1 is a veterinarian, and the rest are animal keepers and forest guards. Personnel from the AFD, WTI and CRWC collaborate in the rescue operations. Other than rescuers, civil security personnel are deployed for crowd control and security.

3.4 Modes of Transportation

Various types of vehicles have been used over the years in rescue operations. Since there exists no specific vehicle for animal rescue designed for their needs, the WTI team built a vehicle modified for their specific needs. The vehicle was inadequately designed and posed multiple challenges to the team. Moreover, the vehicle had become very heavy and also posed problems during formal registration. The team discarded the vehicle and switched back to standard vehicles.

- Mahindra Bolero Camper: Most commonly used rescue vehicle due to off-road abilities, 4 people seating and the pickup bed in the back. The vehicle is used to commute personnel to and from rescue sites and to transport most rescued animals on its back, with or without a cage. The vehicle has high utility for its price and is also relatively easy to maintain. The vehicles are also used to carry rescue supplies, equipment and medical kits. For the kind of usage, the vehicle suffers from damaged suspensions and tires frequently. Since multiple operators use the same vehicle, the condition of the vehicle is not communicated between two different users, leading to more severe damage with every use.
- Elephants: Domesticated elephants are best for treading difficult jungle terrains. They can traverse through tall grasses, mud and water

and provide excellent visibility and safety in tall grasses. Elephants can sense the presence of other animals around them and give signals to the people it is transporting. A grown elephant can carry 1 driver and 2 rescuers. The rescuers are very close to their elephants and very proud of them. The elephants reciprocate too.

- Boats: Inflatable Boats are used in shallow waters to traverse through flooded terrain. These rafts have detachable motors and have the option of pedalling. The boats are light and can be pushed out by rescuers if stuck in shallow waters. These boats are also used to carry rations for on-foot rescuers who go out searching for animals near the river banks. There are custom-made metal boats that are used for patrolling and rescuing smaller animals from the water. Locals make rafts using banana tree trunks to aid in rescue operations. Man-powered wooden boats are also utilised in floods to carry smaller animals. Heavier boats can only operate in deeper waters and thus are seldom used in rescue. The boats are carried on pickup trucks to the water bodies.
- Gypsy: For tracking animals and patrolling, this vehicle is very capable and preferred due to its simplicity, capabilities and low maintenance. The problem currently with this vehicle is that spares are getting harder to find. They are using parts from other broken gypsies to repair the ones on duty.
- On-foot: Scouting for animals is largely done on foot also. It has more control and flexibility than any other mode of mobility in the difficult and diverse terrains.
- Excavators/ Earth Movers: These vehicles are used to tow, lift or drag heavy animals to the cages. The buckets are either directly used to carry smaller animals or drag sledges of heavier animals. Officials also use them to get close to dangerous animals like rhinos for tranquilising. The excavators are also used to dig paths for animals stuck in trenches, wells or ponds. The underside of the bucket is sometimes used to push and assist elephants stuck in lower levels.

- Tractors: These vehicles have good pulling capabilities and can traverse swampy and muddy terrain where most other vehicles get stuck. They are used to tow heavy animal cages and animals for difficult rescue sites and are also used for patrolling at shorter distances. Tractors that carry rescue animals attach a trailer at the back but due to their weight, get stuck in muddy places.
- Trucks: Tata 709 and 409 with closed rear carriages are used to transport animals and their cages to and from the rescue sites. They are used for transporting larger animals like buffaloes, rhinos and elephants. These vehicles are not off-road capable and thus are stationed away from difficult terrains.
- Cranes: These vehicles are used to load and unload cages with/without animals from trucks and trailers, or used to lift heavy animals like elephants directly. Since they are heavy, they are stationed on solid ground and the animals are brought within their range.
- Tata Xenon and Telcoline: Bad feedback and low capability
- Scorpio Getaway: High maintenance cost
- Polaris ATV: These vehicles are used for patrolling in the difficult terrains of KNP. The vehicles have good off-road capabilities and are powerful. But since they are sophisticated and used by untrained officials, the vehicles encounter multiple problems that cannot be serviced locally. The vehicles thus are not used.
- Isuzu V-max: Expensive but very capable and comfortable. The vehicle is new in the fleet and its capabilities are yet to be tested. But the operators are confident about the investment.

3.5 Equipements

Various sizes of cages are required to transport the rescued animals in different stages of rescue operations. It is preferable to use wooden cages over metal cages since metal cages pose a risk of sepsis for injured animals. Rubber and

plastic are also safe options. In addition, these materials are lighter and easier to transport and handle. But these lack the strength and durability of metal cages which are critical requirements in cases where the rescued animal is a strong predator, like a tiger.

Snake Capture Kit

Nets are used to physically restrain smaller animals like cats.

Dart guns of different ranges and firing mechanisms are used to shoot tranquilisers. Some guns have a higher range while some have a more penetrating power. Guards also use bolt-action rifles and Assault Rifles for security.

Different kinds of ropes and belts are used for restraining the animals. Cotton ropes are used to tie the limbs of the animals. Thicker ropes are used to pull or assist an animal. Wide belts are used to lift and drag heavy animals.

Drones are used to locate and track an animal remotely. They are used for scouting in difficult terrain.

Medical kits are used to carry necessary medication and necessary chemicals, such as darts and tranquillizers, medicines, emergency drugs, gauges and needles.

Foldable stretchers and mats are used to transport animals to and from a site to the vehicle and to soften the truck bed for animals.

In longer search and rescue operations, rescuers also carry food rations and cooking equipment.

3.6 Human-Machinery-Equipment Involvement

It takes 4 people to lift up a tiger cage onto the back of a pickup truck. The cages are lifted on one side using bamboo and then the other end is slid onto the back.

It takes 5-7 people to lift up a rhino calf on a stretcher

It takes one person to manually lift and drop the heavy metal doors of the tiger cages, using ropes and pulleys

Inflatable boats are inflated in camp and transported on vehicles to avoid the need of carrying an air compressor to site.

Sedated animals have to be rolled onto sledges by humans using physical effort. Attaching belts onto crane hooks is done by humans.

A cage lifted by a crane has to be guided and aligned by the officials on the ground while loading/unloading on a truck.

3.7 Terrain

The park consists of tall elephant grass, marshlands, and dense tropical moist broadleaf forests. The Brahmaputra river marks the boundary on the northern side of the park. Lakes and Mud lands are scattered amongst the undulating terrain of the park.

3.8 Time of Rescue

The time of rescue is determined by the degree of safety in a particular situation. If the risk is high, it is preferable to rescue in bright lighting conditions and hence in the daytime. Patrolling and scouting are also done during the day since it is easier to locate. Night rescues also occur provided the safety of both personnel and animals is guaranteed.

The duration of an operation can be from a few hours to over a week depending on the type of animal and location. Most long operations take time because the animal in need of rescue is difficult to spot and locate.

3.9 Animal Behavior

Predators seek easy prey and thus enter human habitats to hunt their cattle and poultry. Most leopard or tiger-human clashes happen due to this reason. Old or injured cats, chased out from their territory also look for easier sources of food.

3-4 month-old rhinos are harmless. But a 6-month-old rhino is very aggressive and can potentially kill a human.

Mothers around their offspring get angry and it makes tranquilising ineffective. Excitement of any sort reduces the potency of the chemical.

Deers are very timid creatures and have a tendency to die of heart failure when captured.

Elephants and rhinos are naturally friendly to each other, but outside the park and especially with a man on the elephant, rhinos become aggressive towards elephants.

Elephants are intelligent and the domesticated ones have managed to avoid stomping a fallen ranger even when it was running at full speed while being charged by a rhino.

Rhinos are capable enough to break the hydraulic lifters of excavators.

Tigers if male, stray out of boundaries if it is chased out of their territory due to age or incapacities. The fittest stay in the park and hunt. Females stray out during pregnancies. In tiger rescue, determining the gender determines the

course of action taken, as tranquilising a female poses a risk of hurting the unborn calves.

3.10 Human Interference and Injuries in Rescue

Crowd management is a serious problem in all rescue operations. Hundreds of people gather at the rescue sights and add to the troubles of the rescue team. A Crowd is accompanied by excessive noise and path blockage. This scares and agitates the animals making them more unpredictable.

A tranquilised animal requires silence for the medication to function. If there is noise and the animal is agitated, it does not work effectively. In an incident, a semi-sedated leopard sprung back to bite the rescuer and the rescuer had to sacrifice his hand to save its neck from being bitten.

Rescuers require additional security for crowd control since they are not trained to handle these situations.

Although the locals are in recent times trained through awareness programmes prior to flood seasons and even during off seasons, very few cooperate fully with the rescue teams.

Onlookers and media personnel interfere with the operations to get pictures of the involved animal and end up putting the whole operation at risk. There are incidents where a person looking for a selfie was rammed and severely injured by a rhino. In another case, a media person threw a stone at a resting tiger to get a better view, which aggravated the tiger and it attacked a forest guard. The animal had to be shot down which was unavoidable.

In rescue operations involving tigers and rhinos, tranquillisation is done while being mounted on an elephant. There are incidents where tigers have jumped up to the saddle of the elephant and injured the rescuers. In another case, the

domesticated elephants were chased by an aggressive rhino due to which the saddle unbuckled and the forest guard hung upside-down for a distance and finally fell down on the ground, barely saved from being trampled by the elephant.

Occupational hazard is very high and fractures and injuries are very common.

3.11 Human Interventions

Hydrology of KNPTR is a critical component in its ecosystem. With various interventions by humans in the quest for development, the natural drainage of flood water is affected negatively.

The KNPTR boundaries are defined by humans. But for the animals, the Kaziranga park and the Karbi Anglong Hills are a part of one single ecosystem. Animals are not bothered by political boundaries, but since they exist, humans have started altering the system.

The National Highway 37 or Assam Highway 1 (NH37 or AH1) cuts through the park. And around this highway, commercial and residential establishments have started growing in area. Large areas are also encroached on by illegal immigrants. All these have impacted the park's ecosystem.

Artificial Highlands that were constructed in the park for flood control, are not sustainable and short-term. Although these save a large number of animals, they are altering the natural environment and water flow. The ecosystem is best maintained by nature when uninterrupted by humans.

There are dams being constructed upstream of the Brahmaputra in Arunachal Pradesh. These dams are going to severely alter the water flow in the river and ultimately in the park. The water-dependent ecosystem is going to be severely impacted.

3.12 Requirements for a rescue vehicle

- 4x4, off-road capable, traction controls
- Should Seat 4 people comfortably, considering the stress levels of an operation
- Rainproof
- Should accommodate different sizes of cages
- The track should not be very wide
- Easy to maintain and repair.
- Utilitarian but not sophisticated
- Should accommodate Guns, 2 foldable stretchers, and a medical box
- Powered lifting, maybe through hydraulics or winch
- Adequate storage space
- Should be well-ventilated but also covered; else insects and snakes fall in from trees.
- Cages should be lighter but stronger
- Cages should have weighing equipment, temperature and humidity control
- Cost efficiency is critical; but willing to spend for good value
- A surveillance system at the rear bed
- Should have water and sanitation facility for the animals
- Should Food therapy stands and IV stand for animals
- Boats need to be light but spacious



Fig. 3a Images Captured from Field Research



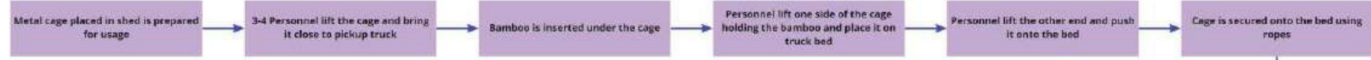
Fig. 3b Images Captured from Field Research

4. Visual Mapping and Diagrams

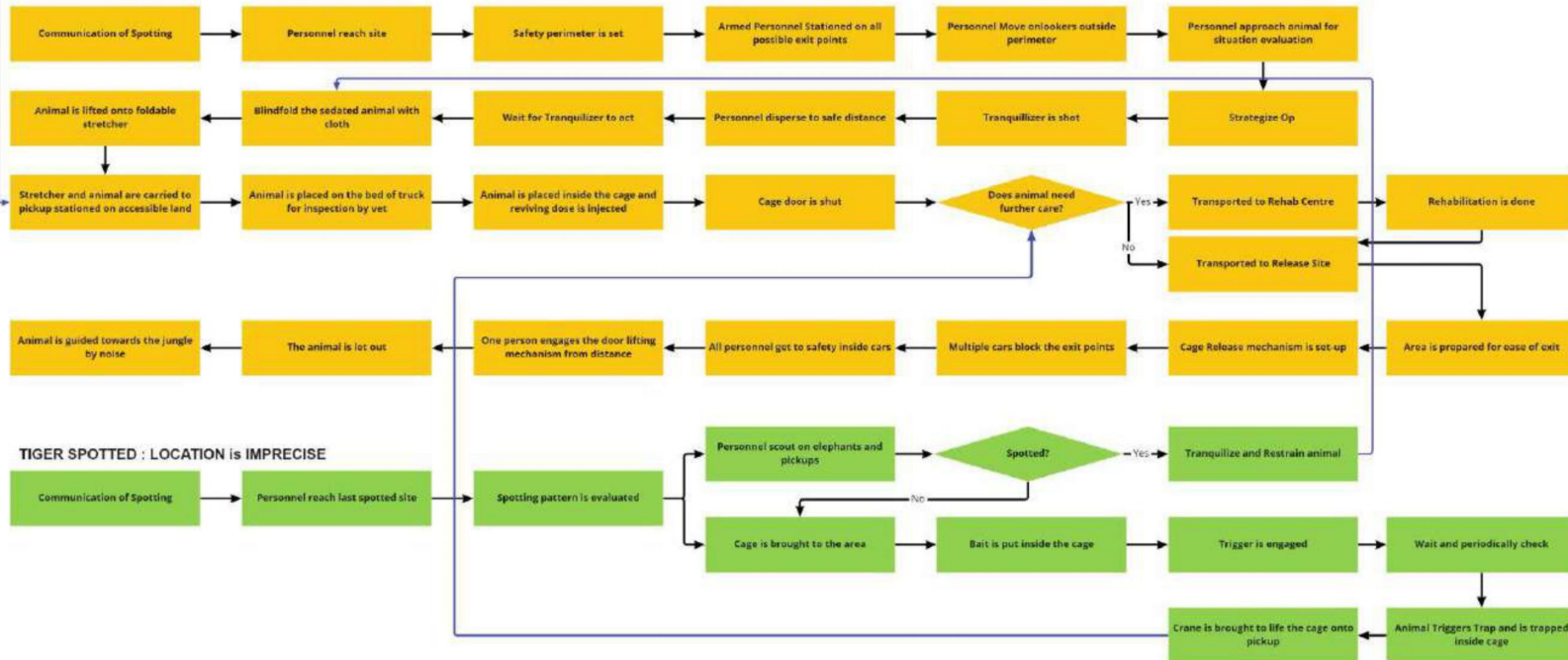


Fig. 4a Gigamap of Data from Primary Research

LOADING A TIGER CAGE ON PICKUP TRUCK



TIGER SPOTTED IN RESIDENCIAL AREA



TIGER SPOTTED : LOCATION is IMPRECISE

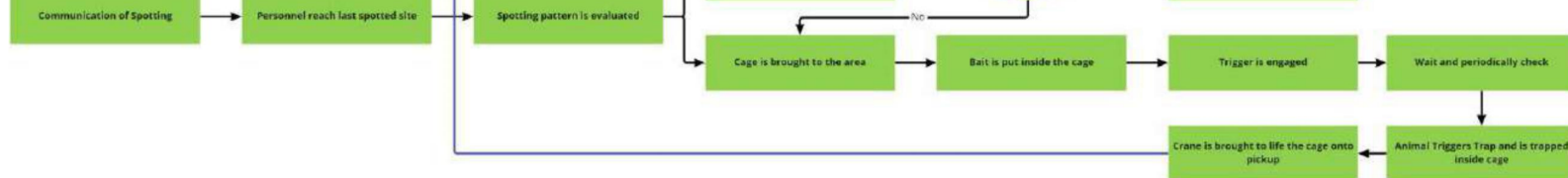


Fig.4b Stages of Operation in a Tiger rescue

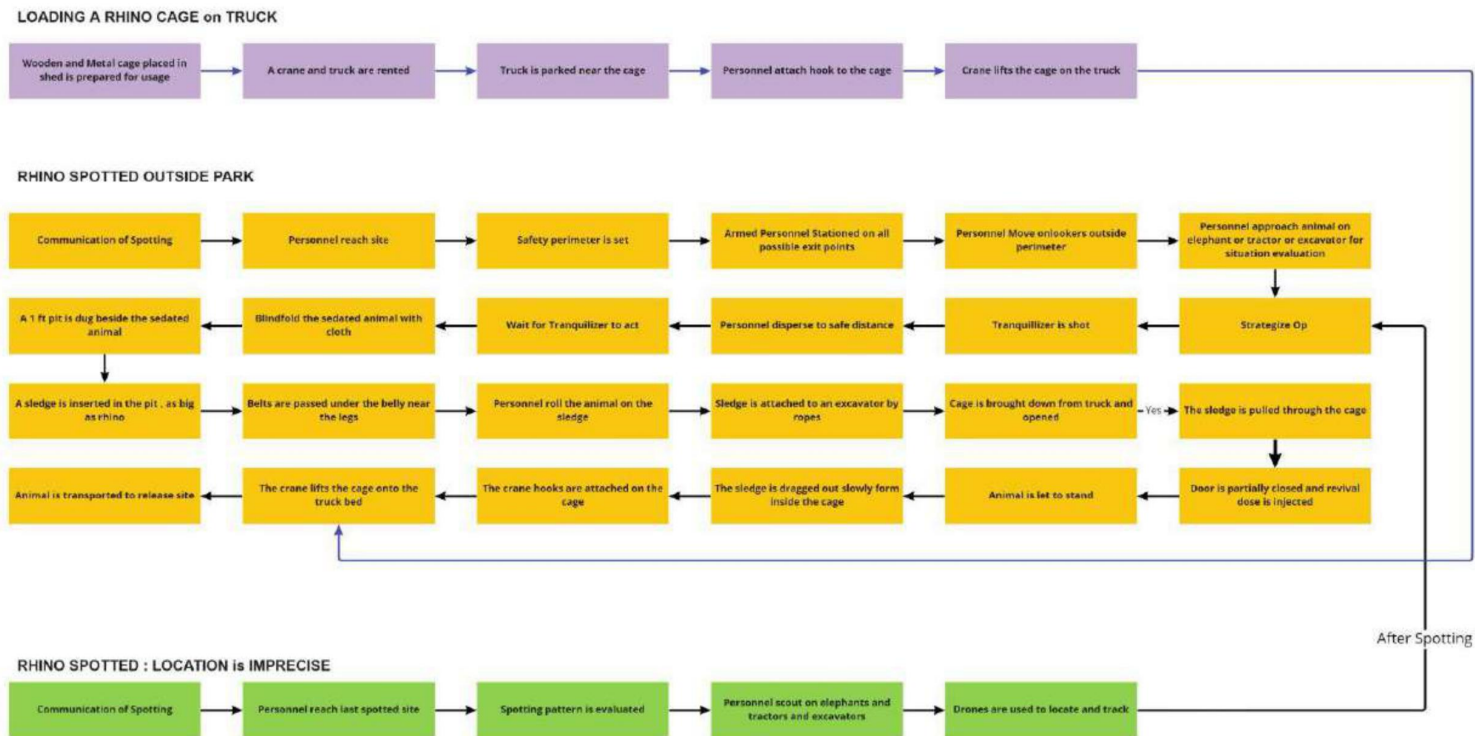


Fig.4c Stages of Operation in a Rhino rescue

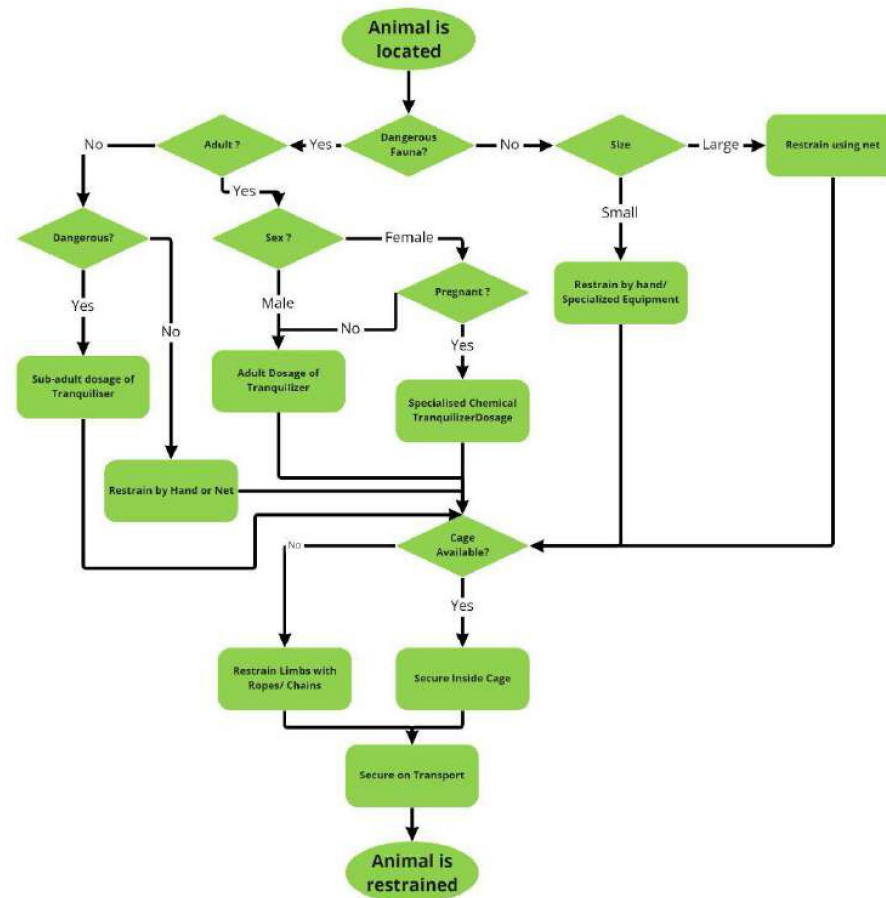


Fig. 4d Decision making in a typical rescue operation

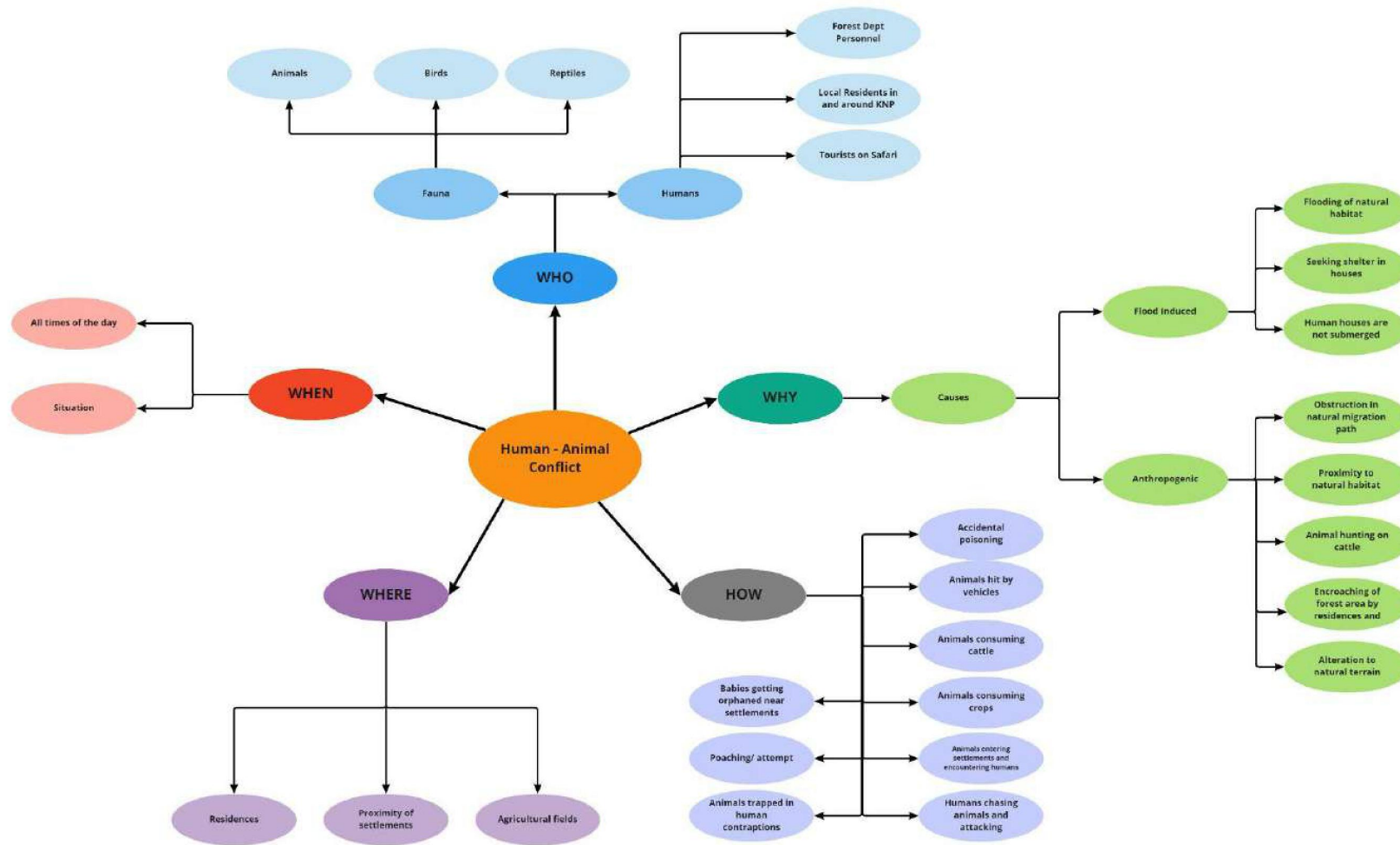


Fig.4e Mind Map: Human-Animal Conflict

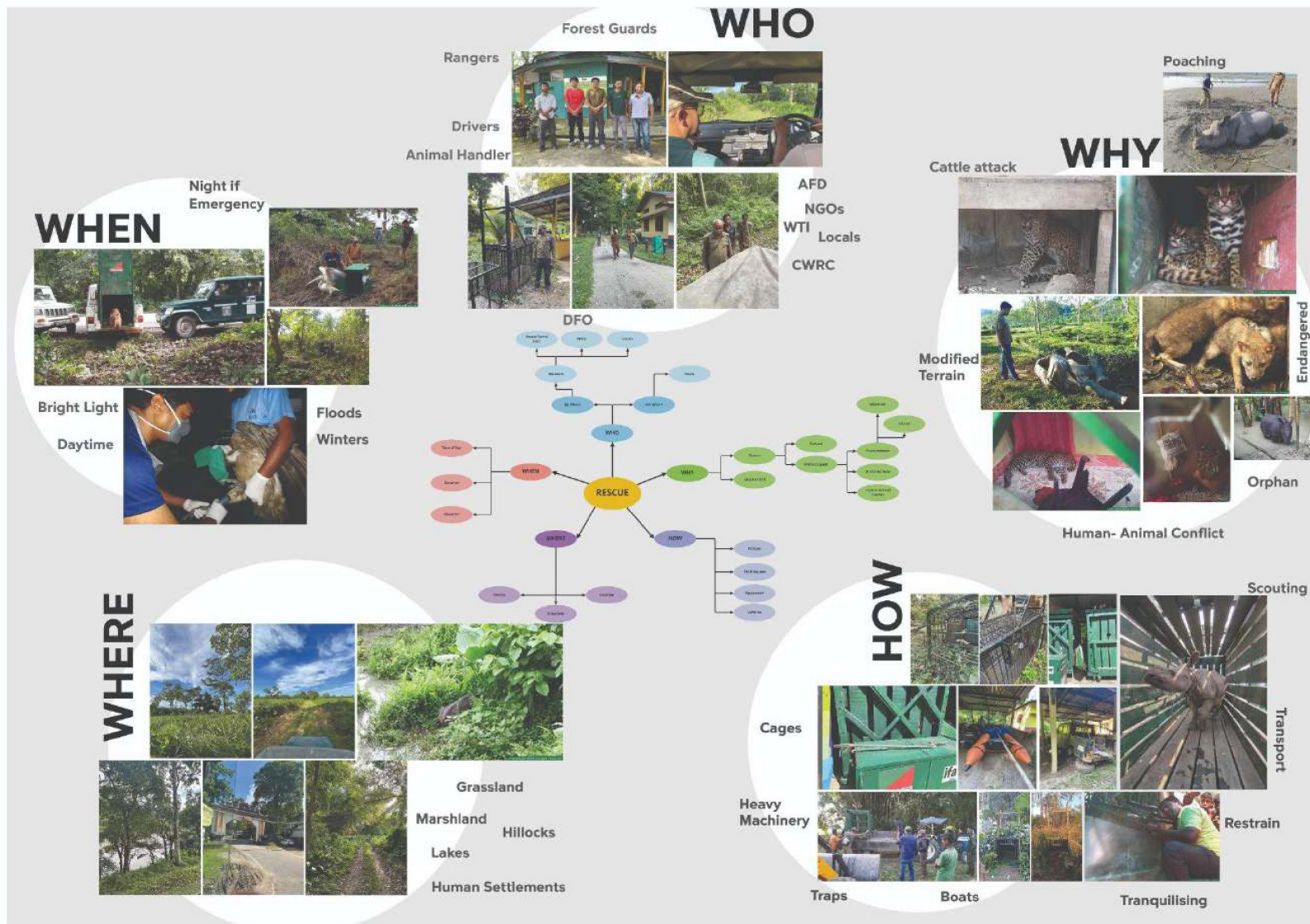


Fig. 4f Visuals for Mind Map post field study

5. Insights



Fig. 5a Insights from field study

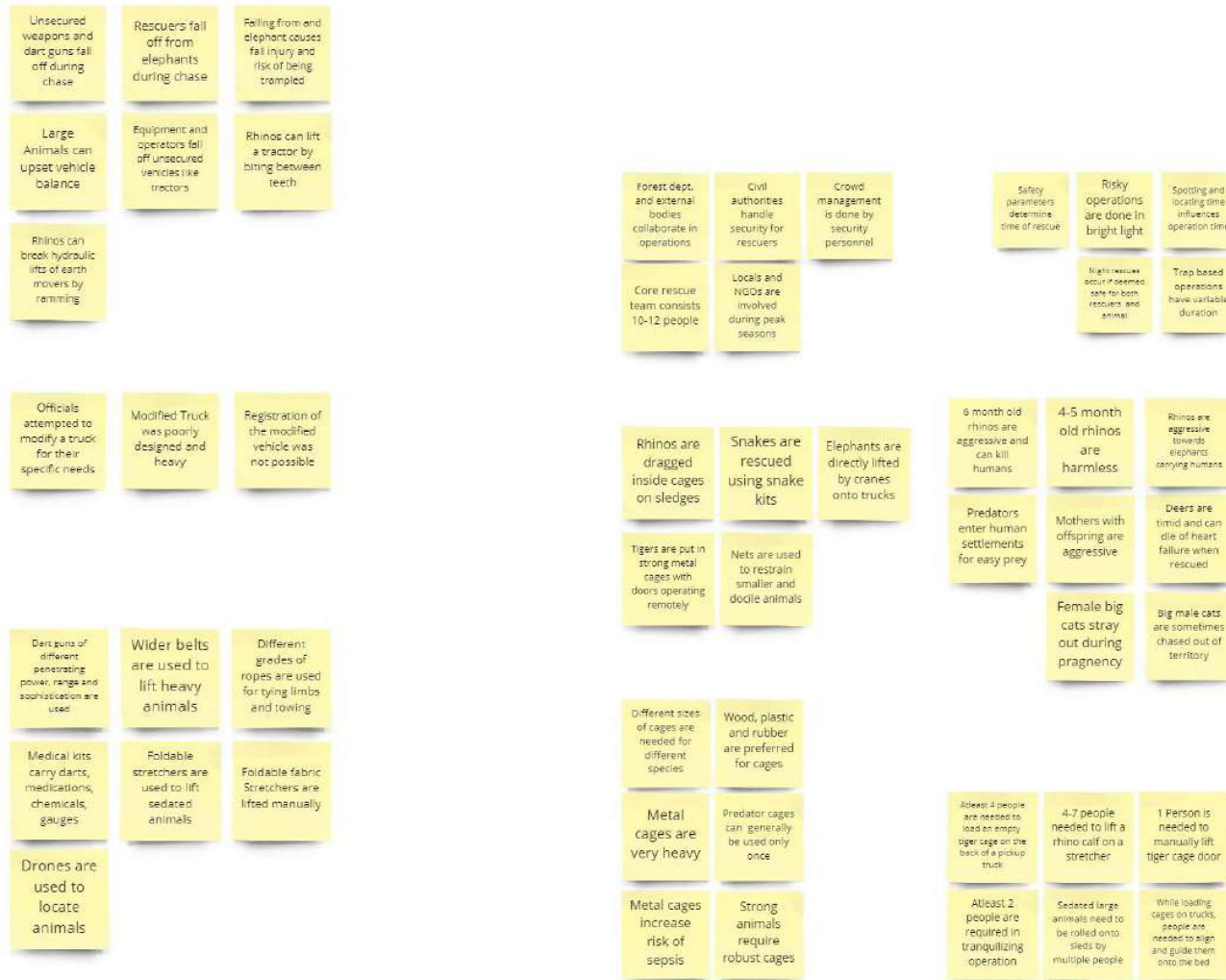


Fig. 5b Insights from field study

6. Insights for Designers

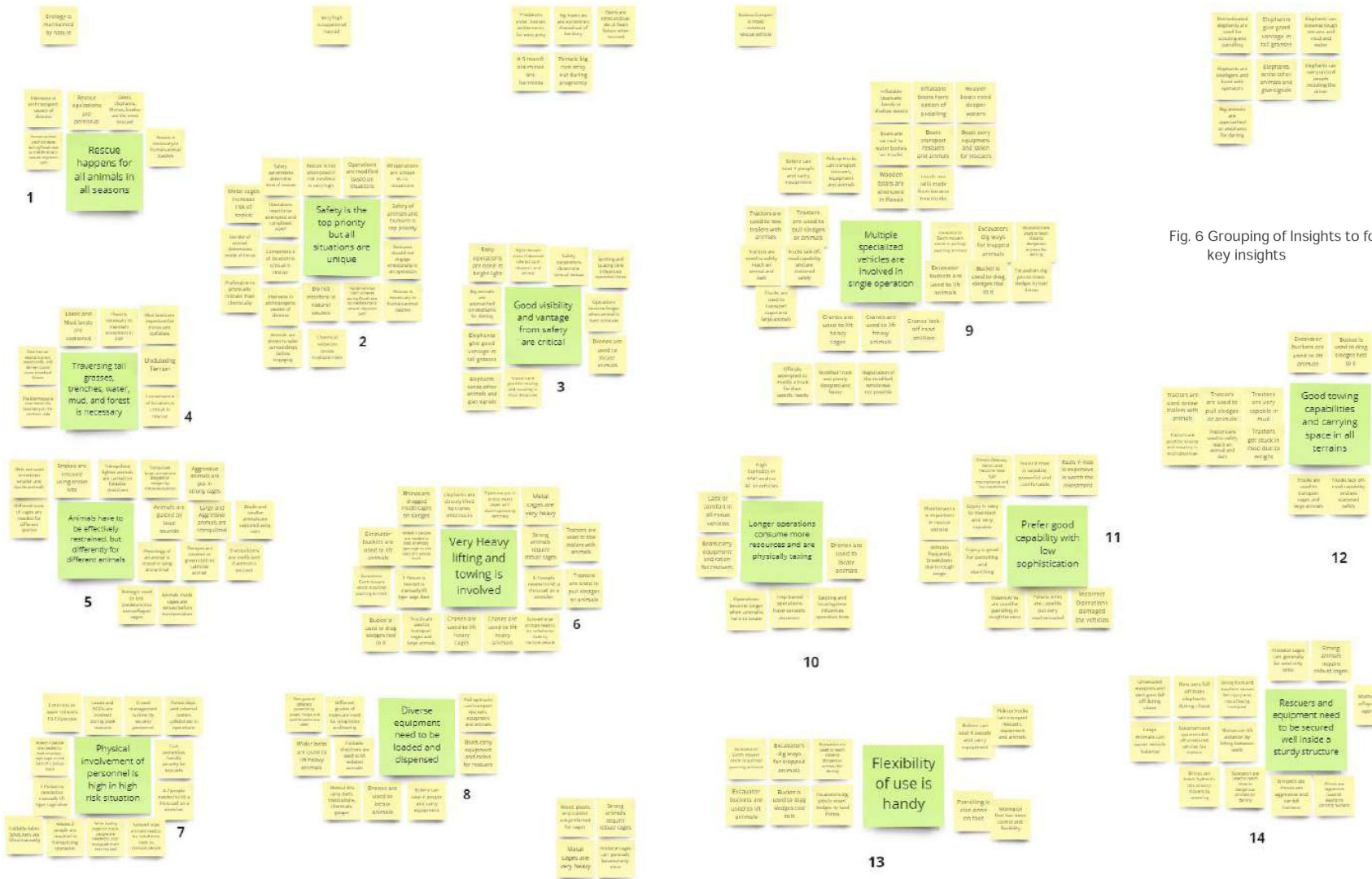


Fig. 6 Grouping of Insights to formulate key insights

7. Priority Matrix

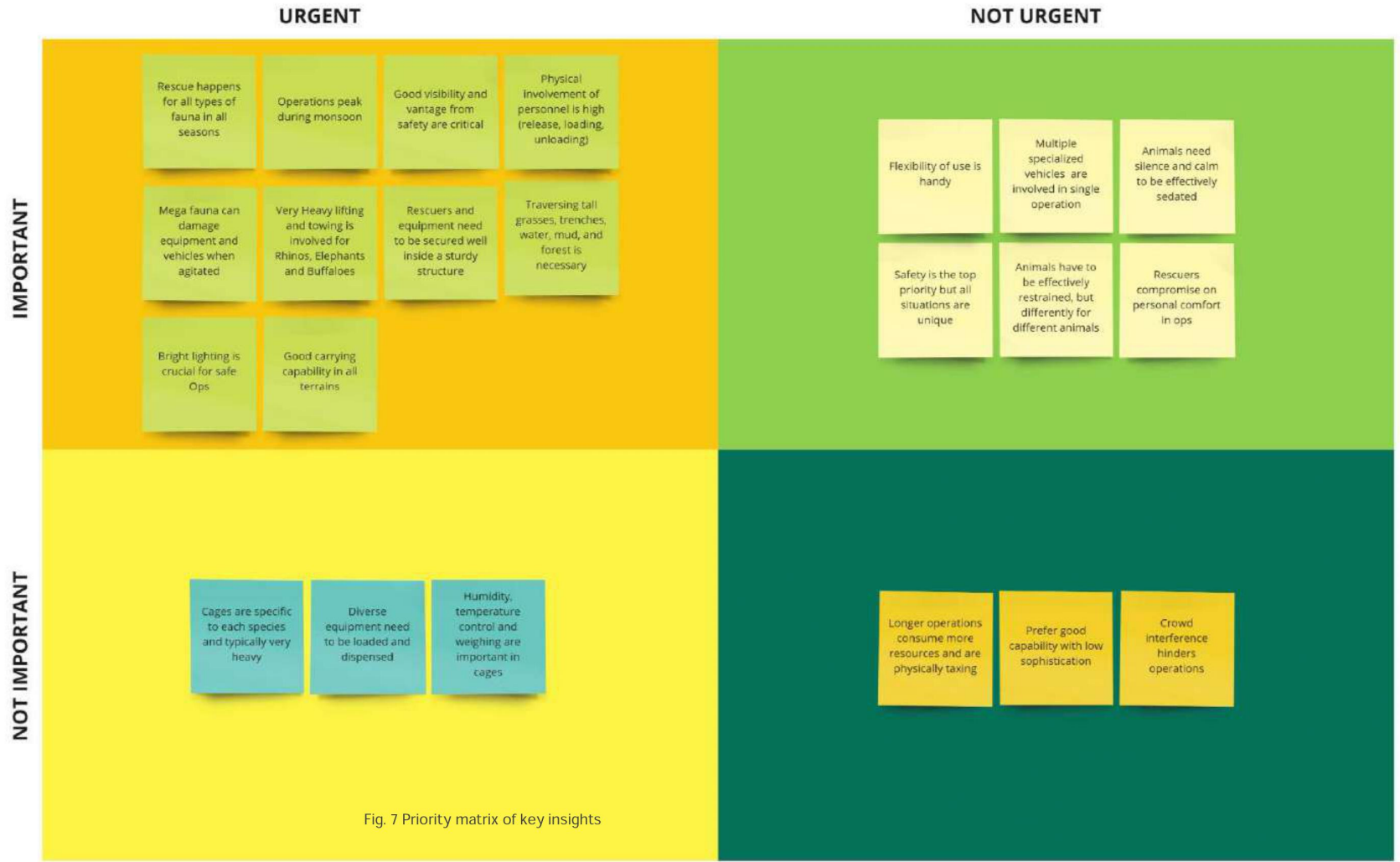


Fig. 7 Priority matrix of key insights

8. Design Brief

Design Requirements from the Priority Matrix

- To be able to traverse the grasslands, forest, mud, hillocks and water and rescue fauna of the park throughout the year, and be rugged enough to handle the challenges of monsoon and floods.
- To have good towing and carrying capabilities and be able to traverse the terrains even when fully loaded
- To be highly manoeuvrable and compact to traverse through dense forest
- To provide a sturdy structure that can secure rescue personnel and equipment from elements and wildlife
- To provide good visibility and vantage for scouting from safety
- To facilitate easy loading, and unloading for cages of all sizes, and to operate the cages safely, remotely.
- To enable easy storage and deployment of equipment and accessories in rescue operations

DESIGN BRIEF

To design an all-terrain, flood-ready, compact wildlife rescue vehicle for Kaziranga National Park to rescue fauna of tiger weight-class and below.

A vehicle that can assist in rescue operations mechanically and aid in scouting and transporting fauna and personnel in every season. The vehicle should be a safe interaction for both rescuers and the rescued and should enable efficient equipment deployment, easy loading, unloading and operation of the cages safely. Various sizes of cages for the specified category of fauna should be accommodated conveniently. The vehicle should enable the rescuers to carry out in-situ rescue and release and also act as a mobile veterinary station. The vehicle should have technologies to aid the operations while also being simple to manage. The vehicle should safely and comfortably accommodate a maximum of three rescue personnel in a cabin designed to securely and conveniently store equipment and accessories

Brief

To design an all-terrain, flood ready, compact animal rescue vehicle for Kaziranga National Park to rescue fauna of tiger weight-class and below.

Functions

Aiding in operations mechanically, Scouting, Transporting fauna and personnel, Carry rescue equipment, Security

PERSONA

Name	Arunav Barua, 31
Designation	Forest Range Officer, AFD
Qualification	B.Sc. in Botany, APSC
Marital Status	Married, has a 2 yo. Daughter
Duties	<ul style="list-style-type: none">-Overseeing the Kohora Range of KNP-Reporting to the DFO-Patrolling on Brahmaputra and Park-Ops & Vigilance against Poachers-Overseeing Team & executing rescues-Field Duty and days of camping in forest & on boats for inspection
Personality	Adventurous, Energetic, Motivated, Composed, and Decisive Enjoys Trekking, Camping, Star gazing, Bird Watching, Wants to try Sky diving
Aspirations	Wishes to see a conflict free KNP Wishes to leave a mark like Jedav Payeng Wishes that future generations understand the need for conservation To own and Restore a Suzuki Gypsy
Apprehensions	Worried about long term effect of short term human interventions to protect the nature



Fig. 8 Persona Board

9. Benchmarking

9.1 Areas of Possible Intervention

The rescue operations were divided into broad stages to determine the specific area that can be possibly intervened. Operations with similar activities were classified together and based on these broad categories, benchmarking of possible solutions was done. The benchmarked solutions were across domains beyond automotive as well.

The operations that could be intervened in were supported with images of possible solutions. The stages of possible intervention were, Personnel Reaching the Rescue Site, Setting up a safety perimeter for the public and animal, Assessment of situation, Restraining the animal in question, Transporting the animal to the vehicle or veterinary station, loading the animal on the vehicle, operating the cage doors, secure harnessing of the animal and cage onto the vehicle, and cleaning on cage after every operation.

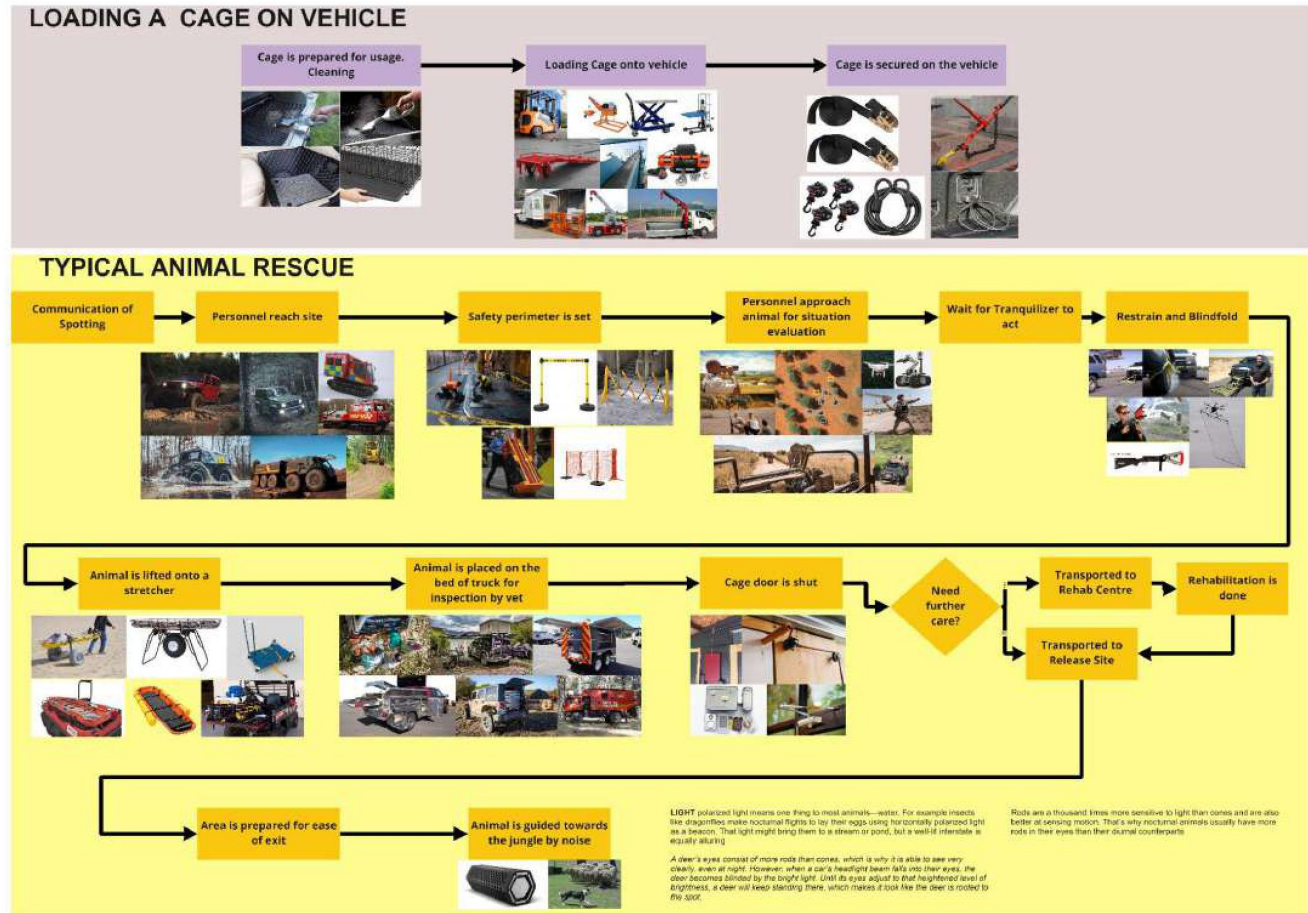


Fig. 9a Stages of Operations requiring design intervention

9.2 Rescue Operations around the globe

Different rescue methods that are in application around the world were benchmarked. This encompasses rescue in different wildlife parks, in different geographical conditions, and for various different categories of animals.

The study focused on animal rescue operations exclusively.

Operations dealing with mega animals were studied to learn about how the lifting and transportation of these animals are done. The equipment involved and the techniques utilised were observed.

Various wildlife park rescue vehicles were studied to understand the approaches taken across different geographical conditions.

Special scenarios of animal rescue were researched, such as airlifting and rescues from seas. The need and procedures for such operations were understood. Rescue in urban floods was also studied to understand methods and vehicles of operation in shallow waters.

Animal ambulances were researched for mechanisms of lifting and transporting.

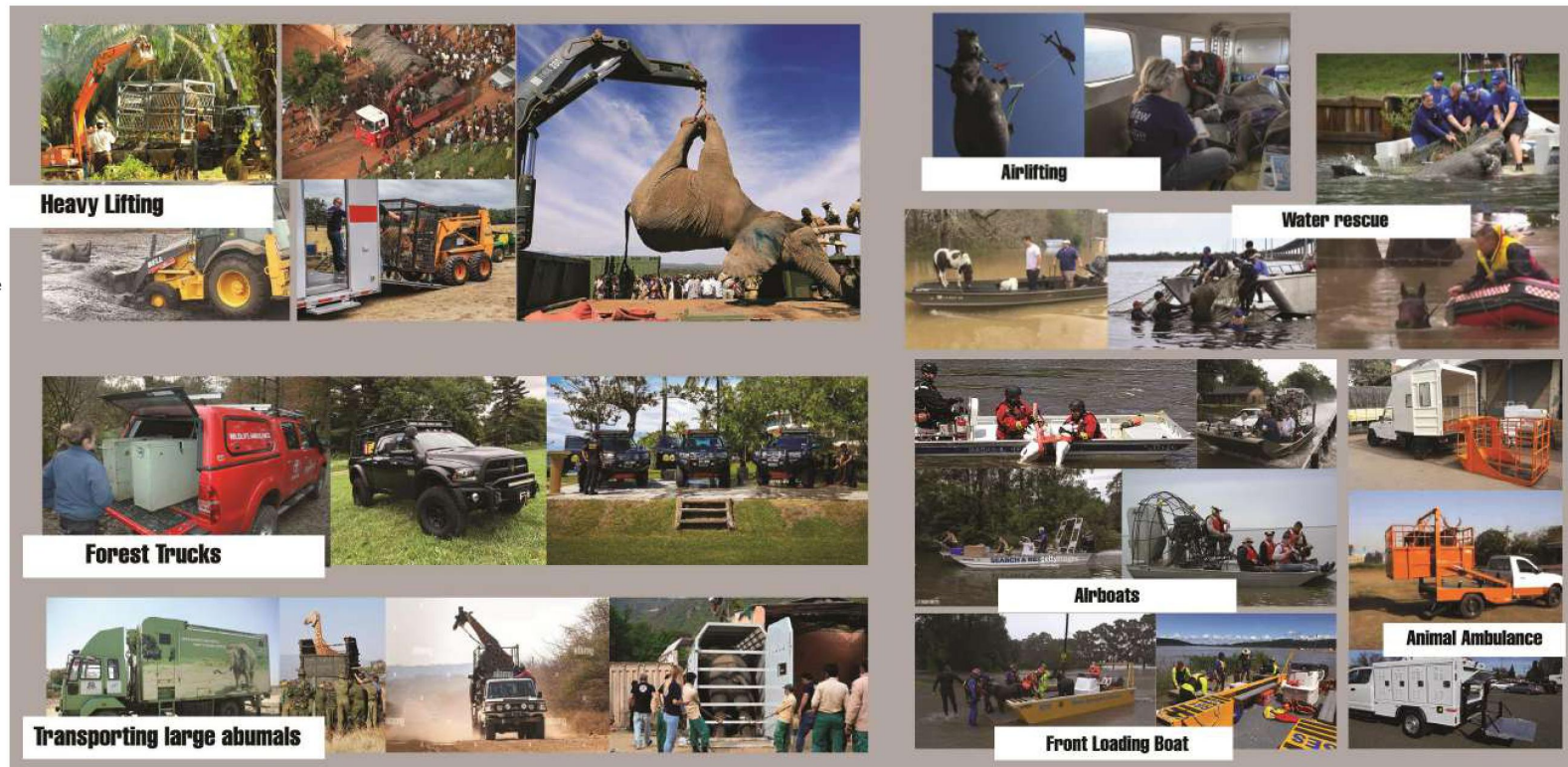


Fig. 9b Rescue Operations Around the Globe

9.3 Specialized Rescue Vehicles

Research was conducted on specialized vehicles made for rescue. This included vehicles for animal as well as human rescues. The types of operations and the specialisation were different and were meant for varying scenarios. Vehicles like the SHERP, Agrocatt, and Ghe-O are all-terrain

Vehicles specialising in traversing both land and water. The Russian Blue Bird is a heavy-duty amphibian with a floating crane attached to it. The Unimog can traverse off-road and carry an array of equipment with it.

The Discovery Rescue is a scouting vehicle that has decent off-road abilities but primarily is a

Mobile veterinary and drone station.

Tech-rich vehicles of the military were also researched. Unmanned rescue and recon vehicles were studied. These remote-controlled vehicles come as amphibians and drones and can carry personnel and equipment.



Fig.9c Specialized rescue vehicles

9.4 Specialized Functionality

Vehicles and equipment with specialised functionality beyond rescue operations were researched.

The focus was on the ability to traverse extreme terrains and versatility. These vehicles and equipment were benchmarked to check

the feasibility of concepts that were being generated simultaneously.



Fig. 9d Specialised functionality vehicles

10. Concepts

10.1 Ideation and Exploration

Along with research and benchmarking, concepts were explored for the chosen areas of

intervention. The key focus was on the area of personnel reaching a site and the ease of loading

an animal onto the vehicle.

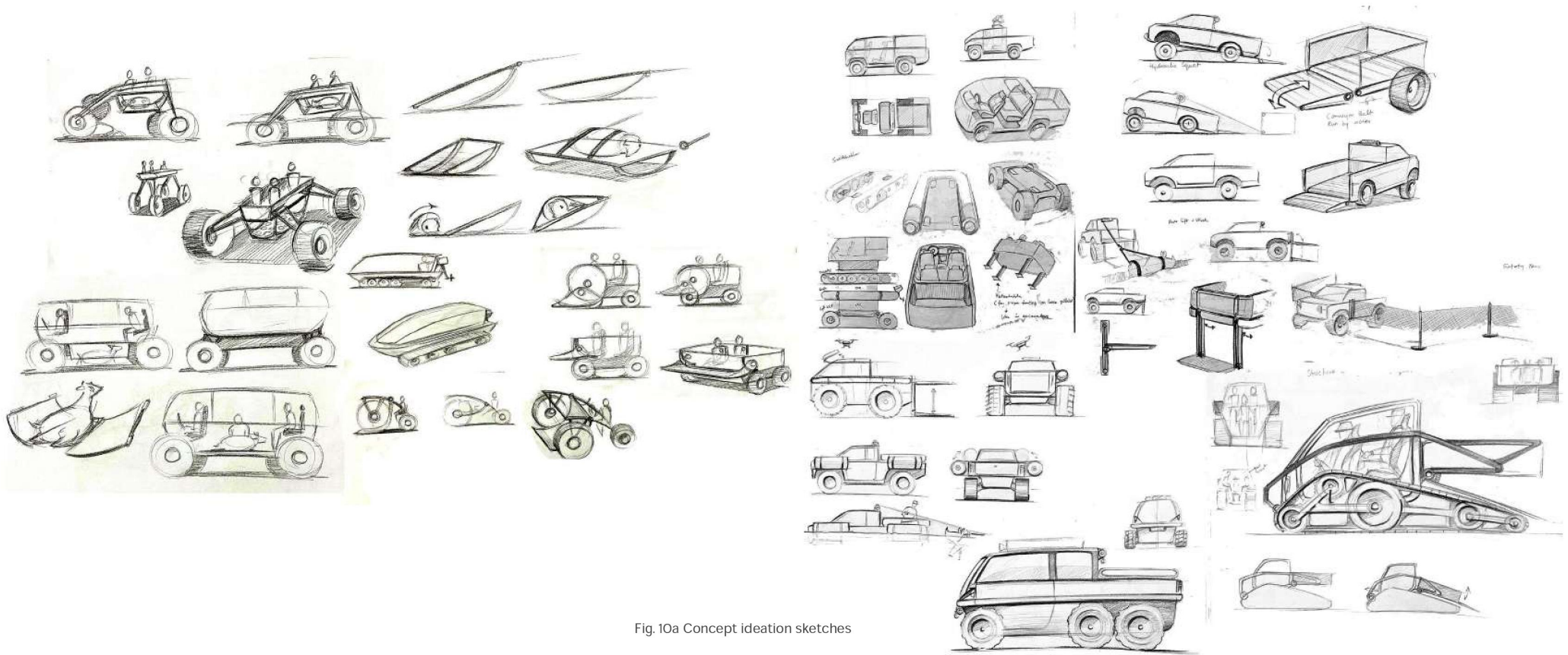


Fig. 10a Concept ideation sketches

10.2 Direction chosen: Justification

Several directions were explored to address the requirements of the brief. Options of height-changing off-road transporters, vehicles with grappling and capturing mechanisms, modular vehicles that can switch between boat and land modes, track-driven compact buggies, conveyor belt incorporated beds and amphibian pickups were conceptualised and evaluated to decide on a direction for proceeding.

Although multiple options were seen as feasible options, the best option was decided by revisiting the context and the priority matrix derived in Section 7 of this report.

Considering the necessity to traverse varying depths of water during monsoons, the ability to float was determined as important. Since it is difficult to operate an outboard propeller boat in shallow waters, and more importantly the need for a rescue vehicle is not restricted to only monsoons and floods, the vehicle also needed to have off-road capabilities. The requirement for floods is a special annual case, but rescue operations in and around the park, happen throughout the year. These two parameters dictated that the vehicle has to be an amphibian off-roader.

The forest personnel currently use elephants to enter the dense forest areas and proceed to

tread on foot in the deeper jungles, since their existing vehicles are not compact or capable enough to enter the undulating and uncertain mix of terrain. Thus along with good off-road abilities, the vehicle had to be compact for the wooded forest and highly manoeuvrable to access areas beyond tight passages.

The category of fauna for rescue (weight class of tiger and below) There are numerous animals that are ferocious and aggressive, which requires them to be separated from the rescuers while being transported. Although these animals are sedated during loading, they are transported when they are fully conscious. Considering the safety of both the animal and the rescuer, the designated areas for both are separated. Also, the need for a sufficiently spacious cabin comes from the requirement of a safe and comfortable space for the operators who spend several hours of a day while on search and rescue operations in the tough terrains and mostly humid climate, through an unpredictable wilderness nesting an array of potentially dangerous creatures. Rescue operations require a lot of on-foot thinking and are taxing mentally and physically, and being comfortable enables the rescuers to judge better and act more efficiently in long operations.

To accommodate larger animals or in cases of rescuing multiple animals in a single operation,

the bed of the vehicle needs to have flexibility in the bed area to maintain its compact form factor but also be capable on-demand. Not all operations require three personnel, and thus cabin space can also be utilised if needed.

A low bed helps easy loading and unloading of heavy cages and animals and thus the ability to lower the bed for easy access is a crucial necessity. The bed also needs to be used for in-situ care for rescued wildlife and thus having an operating height for the bed benefits the situation. Height adjustment is therefore important for the bed.

The height adjustability of the vehicle itself aids in this requirement of a height-changing bed but also is a requirement in off-roading. A height-adjustable suspension enables the vehicle to change its ground clearance, improving breakover angles and fording depth.

Good visibility from the cabin and the ability to get a good vantage point for scouting dictates the requirement for larger window areas and an ability to look out from a higher point from within the car.

With the integration of mechanical aids and newer technological features, the HMI has to be intuitive and well-organised.

10.3 Amphibious EV exploration

Being a vehicle that aids nature, the design has to be as close to nature as it can be. It has to minimise disruption and interference with the

forest ecosystem. An Electric platform here has multiple benefits. It is cleaner, is silent which is a great benefit in minimising disturbance, and it has

higher torque which is crucial in towing and off-roading. Concepts in these lines were explored.

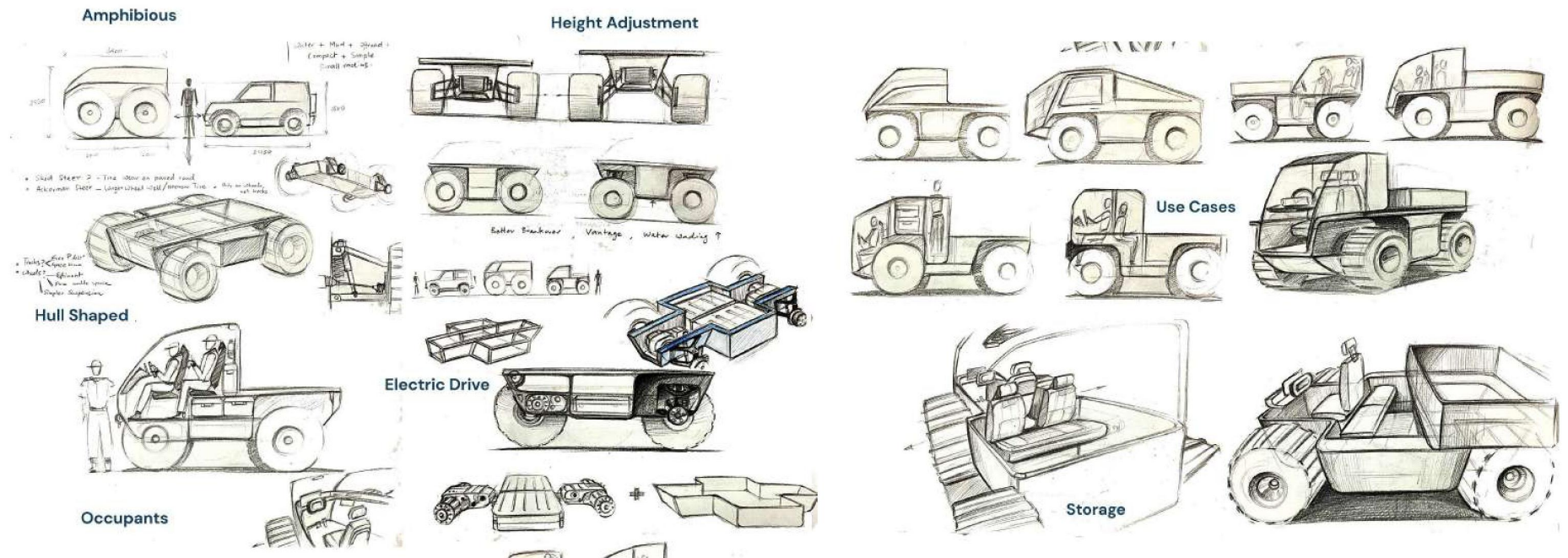


Fig. 10b Amphibian concept ideations

10.4 Exploration through Scenarios

Explorations were done based on the context and scenarios from rescues in Kaziranga National Park.

Capabilities such as the versatility of bed, dual axle steering, loading using winches, modularity

of interior, equipment and control layout, and terrain traversing were explored.

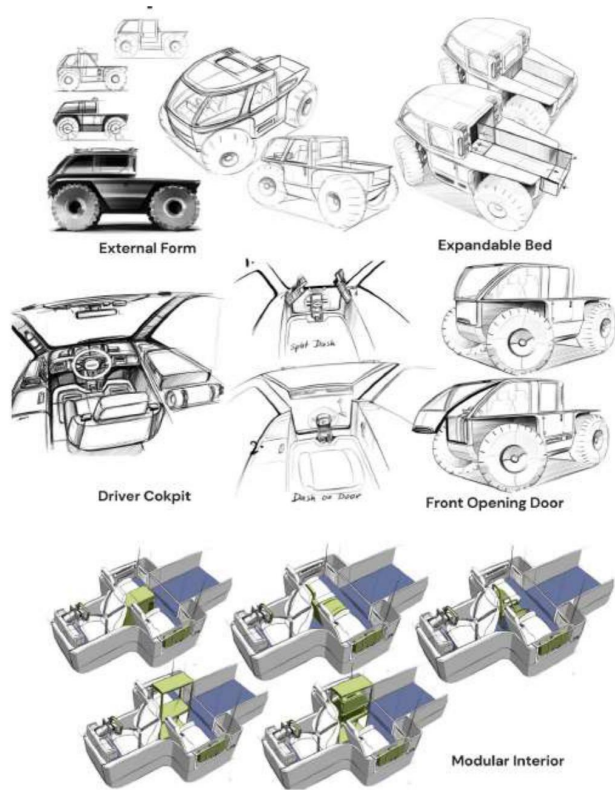


Fig. 10c Feature ideation

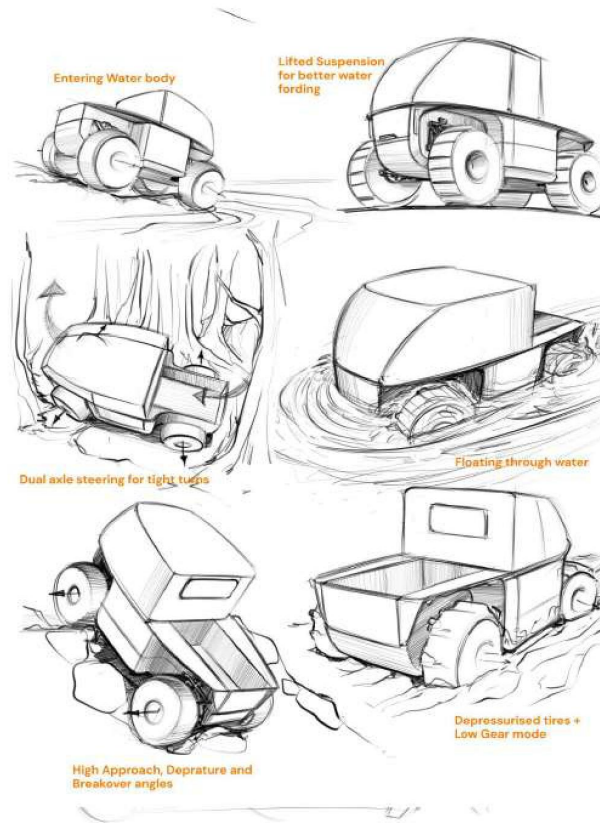
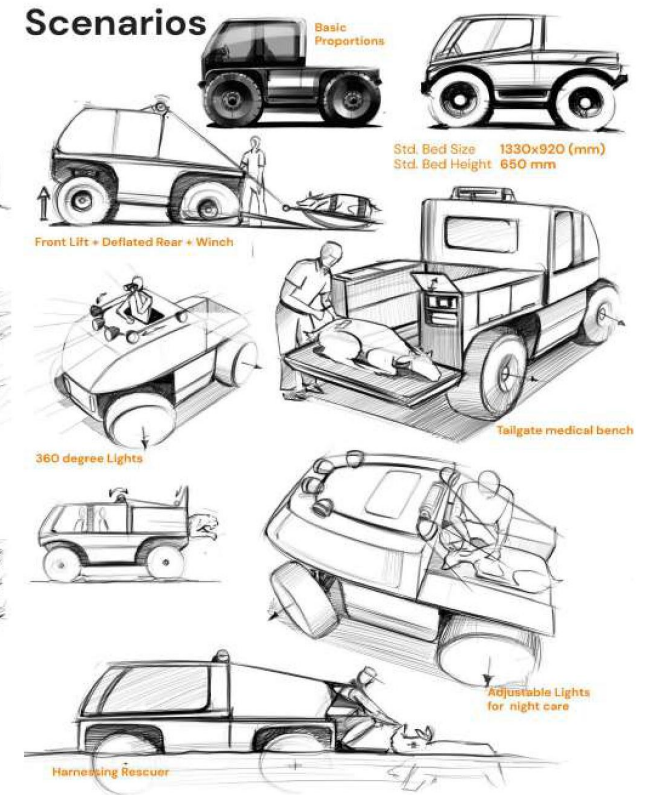


Fig. 10d Scenario Sketches



11. Platform

11.1 CAD Exploration of Platform

The proposed concept was translated into a basic 3D CAD model with all elements of the frame, battery and motor placement, hull-shaped base, wheel travel and turning circle, cabin layout, seat ergonomics, bed area, and storage spaces,

Multiple challenges were encountered with wheel sizes and intended turning radius, without raising the overall height of the vehicle, and reducing cabin space. The bed size was maximised for the fixed exterior dimensions. As only a reference for sizes and not the design or architecture,

the Suzuki Jimny was considered for a decently capable but extremely small off-roader and on the other end of the off-road spectrum, the SHERP, which can conquer all terrains and uses its wheels as propellers.

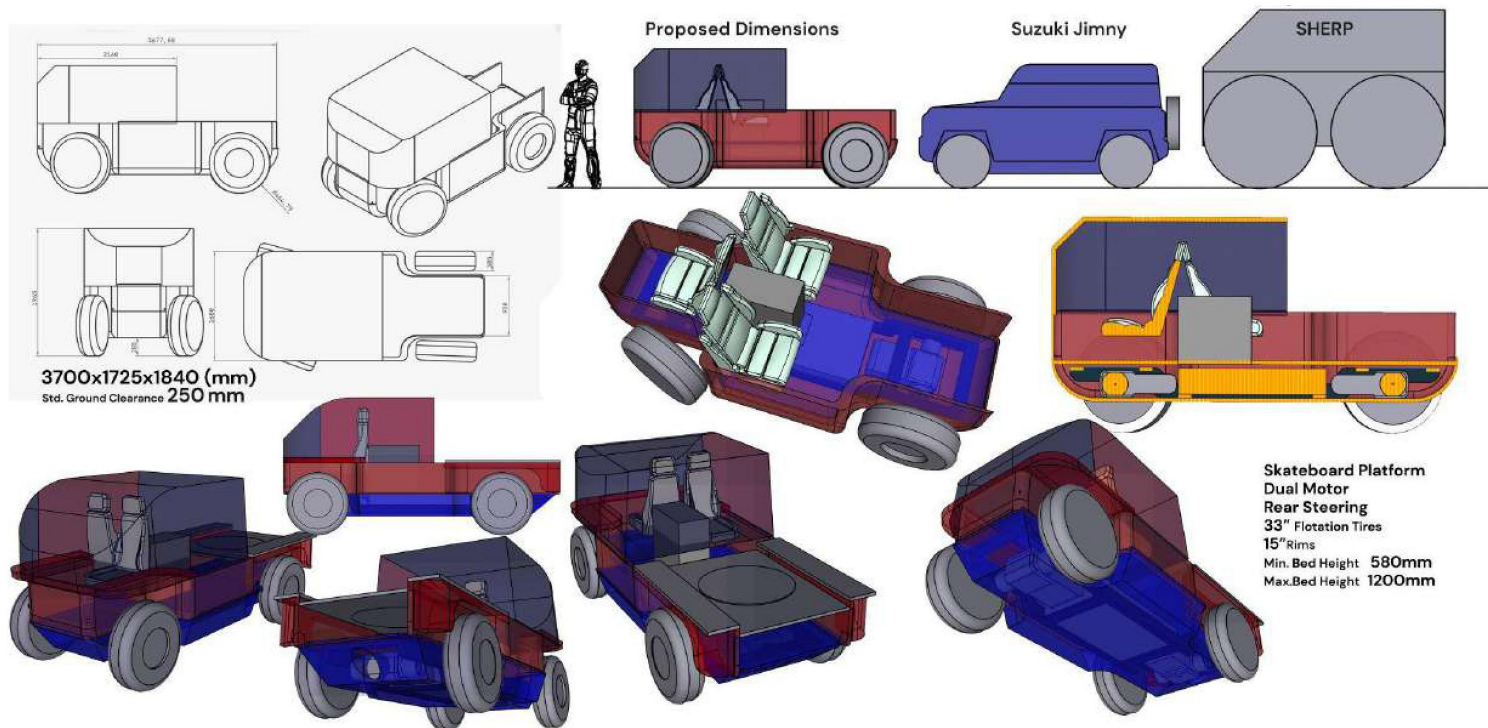
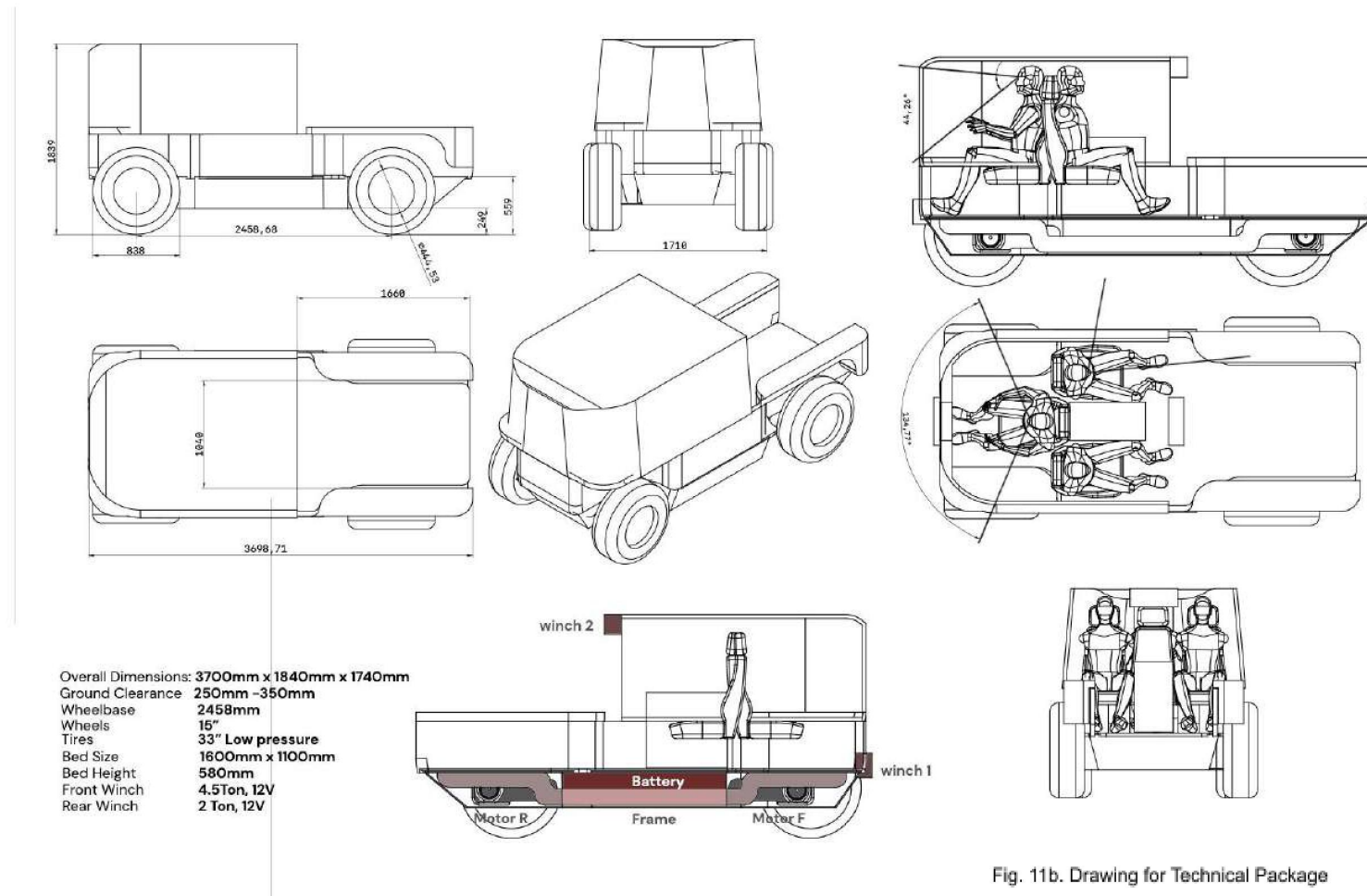


Fig. 11a Initial platform exploration in CAD

11.2 Technical Package

The final package was converted into a CAD drawing describing all essential components and parameters



12. Design Exploration

12.1 Moodboard

A moodboard was created to guide the essence of the vehicle being designed. Subtle, Blended, Native and Union with Nature is the core theme.



Fig. 12a Mood Board

12.2 Theme Board

A theme board was created to guide the styling of the vehicle being designed



Fig. 12b Theme Board

12.3 Form Exploration

Taking cues from the moodboard and the theme board, concepts were explored for both the interior and the exterior.

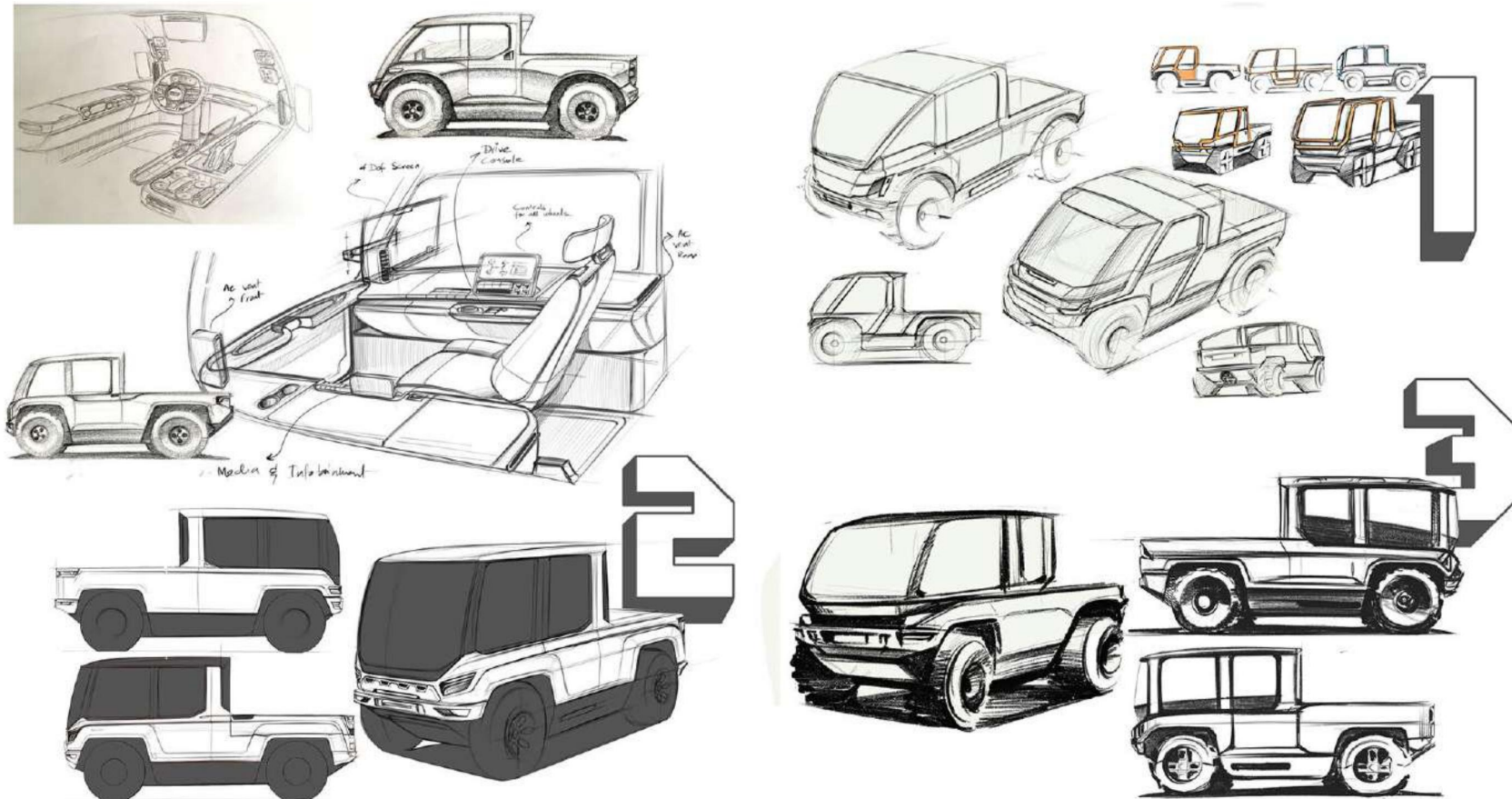


Fig. 12c Interior and Exterior Ideation

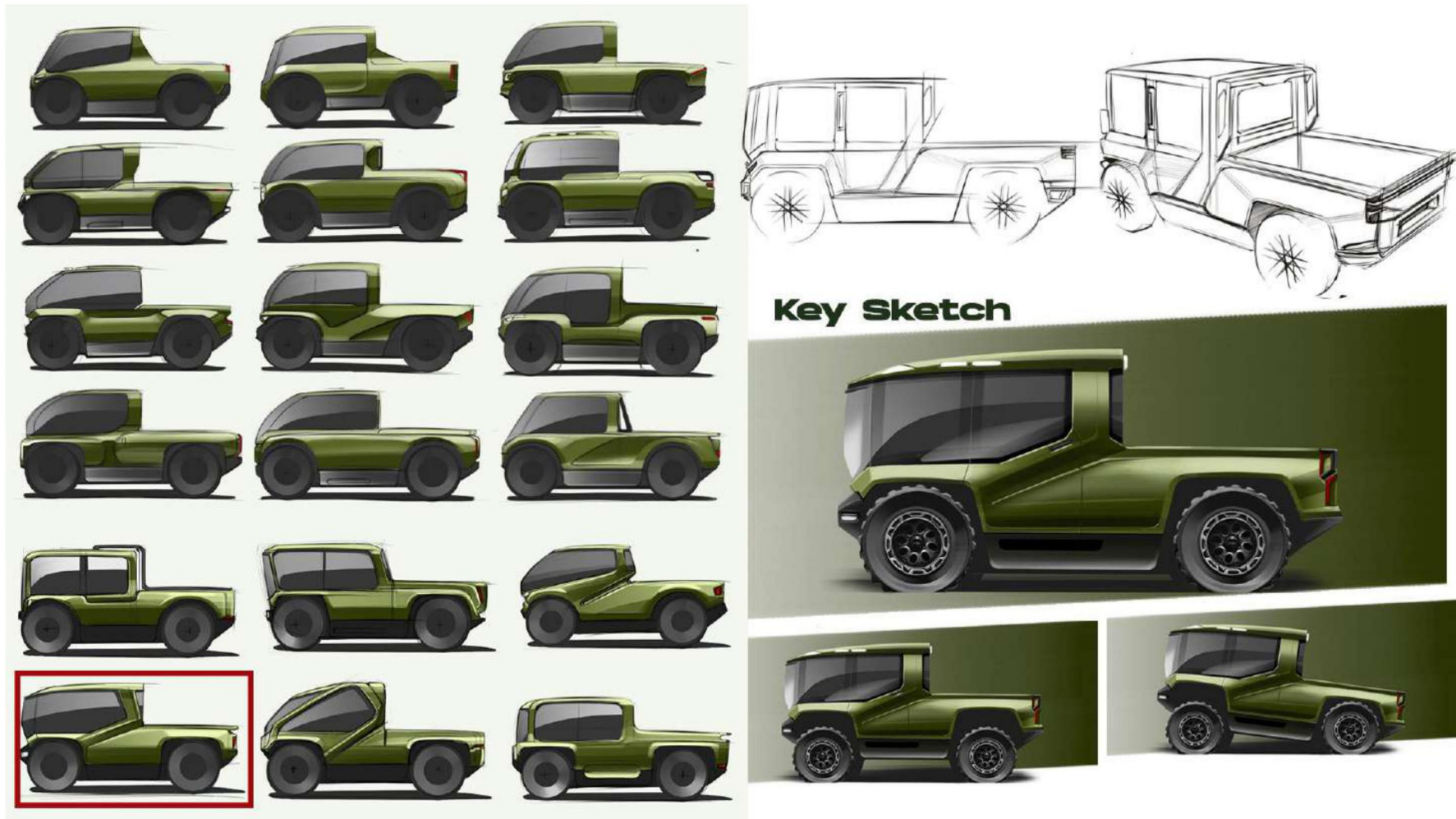


Fig. 12d Form Exploration and Key sketch

12.4 3D Translation

The key sketch was resolved on 3D CAD Shapr3D initially.

Proportion Blocking



Direction : 1



Direction : 2



Fig. 12e CAD Model Versions

12.5 Final 3D Model

With a combination of CAD from Shapr3D and Class A surfacing on Autodesk Alias, the Final 3D model was created



Fig. 12f Final 3D model

13. Final Design Sketch



Fig. 13a Final Design Side view digital render

14. Renders of Design



Fig.14a Interior Renders



Fig. 14b Exterior Renders



Fig. 14c Front Three - Quarter View in Environment



Fig. 14d Rear lamp and auxiliary lamp details



Fig. 14e Environment Render : Forest



Fig. 14f Environment Render : River shore

15. Scale Model

----- WORK IN PROGRESS -----

List of Images

Fig. 1a Location and Ecology of Kaziranga	2	Fig. 10c Feature ideation	32
Fig. 1b Floods in Kaziranga	2	Fig. 10d Scenario Sketches	32
Fig. 3a Images Captured from field Study	11	Fig. 11a Initial platform exploration in CAD	33
Fig. 3b Images Captured from Field Study	11	Fig. 11b Drawing for Technical Package	34
Fig. 4a Gigamap of Data from Primary Research	13	Fig. 12a Mood Board	35
Fig. 4f Visuals for Mind Map post field study	18	Fig. 12b Theme Board	36
Fig. 5a Insights from field study	19	Fig. 12c Interior and Exterior Ideation	37
Fig. 5a Insights from field study	20	Fig. 12d Form Exploration and Key sketch	38
Fig. 6 Grouping of Insights to formulate key insights	21	Fig. 12e CAD Model Versions	39
Fig. 8 Persona Board	24	Fig. 12f Final 3D model	40
Fig. 9a Stages of Operations requiring design intervention	25	Fig. 13a Final Design Side view digital render	41
Fig. 9b Rescue Operations Around the Globe	26	Fig. 14a Interior Renders	42
Fig.9c Specialized rescue vehicles	27	Fig. 14b Exterior Renders	43
Fig. 9d Specialised functionality vehicles	28	Fig. 14c Front Three - Quarter View in Environment	44
Fig. 10a Concept ideation sketches	29	Fig. 14e Environment Render : Forest	45
Fig. 10b Amphibian concept ideations	31	Fig. 14f Environment Render : River shore	46

List of Diagrams

Fig. 2 Mind Map for data collection through interview	3
Fig. 4b Stages of Operation in Tiger rescue	14
Fig. 4c Stages of Operation in rhino rescue	15
Fig. 4d Decision making in a typical rescue operation	16
Fig. 4e Mind Map: Human Animal Conflict	17
Fig. 4f Visuals for Mind Map post field study	18
Fig. 7 priority Matrix	22